

## General information

**IGBT STACK for typical voltage of up to 400V**  
**Rated output current 217A**

- Solar power
- Motor drivers
- 62mm IGBT power module
- Trenchstop™ IGBT 4

Topology	B6I
Application	Inverter
Load type	Resistive, inductive
Semiconductor (Inverter Section)	3 x FF450R12KE4
DC Link	2.4 mF
Heatsink	Forced air cooled (fan not included)
Implemented sensors	Current, voltage, temperature
Driver signals IGBT	Electrical
Design standards	EN 50178
Sales - name	6PS04512E43G37986
SP - No.	SP001046792

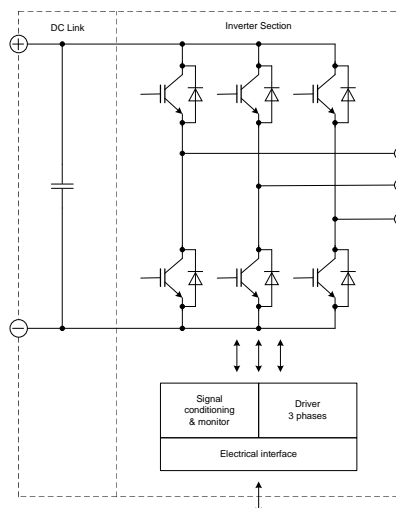
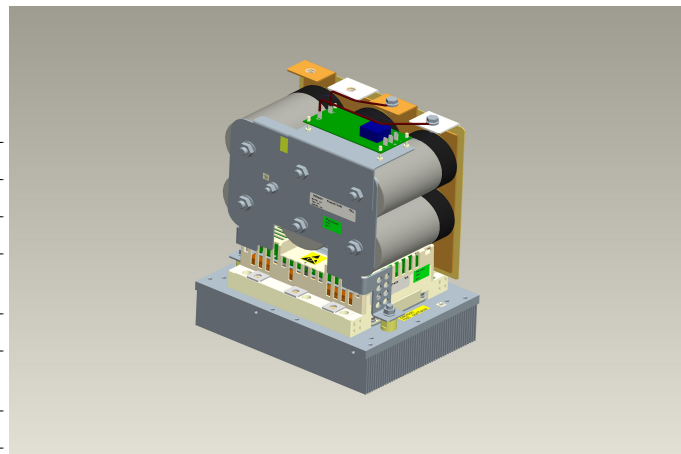

prepared by: OW	date of publication: 2013-10-18
approved by: AR	revision: 2.2

# Technical Information

PrimeSTACK™

# 6PS04512E43G37986



Preliminary data

## Absolute maximum rated values

Collector-emitter voltage	IGBT; $T_{vj} = 25^{\circ}\text{C}$	$V_{CES}$	1200	V
Repetitive peak reverse voltage	Diode; $T_{vj} = 25^{\circ}\text{C}$	$V_{RRM}$	1200	V
DC link voltage	IGBT not switching	$V_{DC}$	900	V
Insulation management	according to installation height of 2000 m	$V_{line}$	500	$V_{RMS}$
Insulation test voltage	according to EN 50178, $f = 50\text{ Hz}$ , $t = 1\text{ s}$	$V_{ISOL}$	2	$kV_{RMS}$
Repetitive peak collector current inverter section (IGBT)	$t_p = 1\text{ ms}$	$I_{CRM2}$	900	A
Repetitive peak forward current inverter section (Diode)	$t_p = 1\text{ ms}$	$I_{FRM2}$	900	A
Continuous current inverter section		$I_{AC2}$	270	$A_{RMS}$
Junction temperature	under switching conditions	$T_{vjop}$	150	$^{\circ}\text{C}$
Switching frequency inverter section		$f_{sw2}$	14	kHz

### Notes

Further maximum ratings are specified in the following dedicated sections

## Characteristic values

### DC Link

			min.	typ.	max.	
Rated voltage		$V_{DC}$		600	850	V
Over voltage shutdown	within 1000 $\mu\text{s}$			850		V
Capacitor	1 s, 6 p	$C_{DC}$		2.4		mF
Maximum ripple current	per device, $T_{amb} = 55^{\circ}\text{C}$	$I_{ripple}$		49		$A_{RMS}$
Balance or discharge resistor	per DC link unit	$R_b$		164		$k\Omega$

### Inverter Section

			min.	typ.	max.	
Rated continuous current	$V_{DC} = 600\text{ V}$ , $V_{AC} = 400\text{ V}_{RMS}$ , $\cos(\varphi) = 0.85$ , $f_{AC\ sine} = 50\text{ Hz}$ , $f_{sw} = 5000\text{ Hz}$ , $T_{inlet} = 40^{\circ}\text{C}$ , $T_j \leq 125^{\circ}\text{C}$	$I_{AC}$		265		$A_{RMS}$
Over current shutdown	within 15 $\mu\text{s}$	$I_{AC\ OC}$		626		$A_{peak}$
Power losses	$I_{AC} = 265\text{ A}$ , $V_{DC} = 600\text{ V}$ , $V_{AC} = 400\text{ V}_{RMS}$ , $\cos(\varphi) = 0.85$ , $f_{AC\ sine} = 50\text{ Hz}$ , $f_{sw} = 5000\text{ Hz}$ , $T_{inlet} = 40^{\circ}\text{C}$ , $T_j \leq 125^{\circ}\text{C}$	$P_{loss}$		2275		W

### Inverter Section (specific condition)

			min.	typ.	max.	
Specific continuous current	$V_{DC} = 750\text{ V}$ , $V_{AC} = 400\text{ V}_{RMS}$ , $\cos(\varphi) = 0.8$ , $f_{AC\ sine} = 50\text{ Hz}$ , $f_{sw} = 5000\text{ Hz}$ , $T_{inlet} = 40^{\circ}\text{C}$ , $T_j \leq 125^{\circ}\text{C}$	$I_{ACsp}$		217		$A_{RMS}$
Continuous current at low frequency	$V_{DC} = 750\text{ V}$ , $V_{AC} = 400\text{ V}_{RMS}$ , $\cos(\varphi) = 0.8$ , $f_{AC\ sine} = 0\text{ Hz}$ , $f_{sw} = 5000\text{ Hz}$ , $T_{inlet} = 40^{\circ}\text{C}$ , $T_j \leq 125^{\circ}\text{C}$	$I_{ACsp}$		105		$A_{RMS}$
Specific continuous current for 150% overload capability	$I_{AC\ 150\%} = 263\text{ A}_{RMS}$ , $t_{on\ over} = 3\text{ s}$ , $T_j \leq 125^{\circ}\text{C}$	$I_{ACsp\ over1}$		175		$A_{RMS}$
Specific continuous current for 150% overload capability	$I_{AC\ 150\%} = 229\text{ A}_{RMS}$ , $t_{on\ over} = 60\text{ s}$ , $T_j \leq 125^{\circ}\text{C}$	$I_{ACsp\ over2}$		152		$A_{RMS}$
Power losses	$I_{AC} = 217\text{ A}$ , $V_{DC} = 750\text{ V}$ , $V_{AC} = 400\text{ V}_{RMS}$ , $\cos(\varphi) = 0.8$ , $f_{AC\ sine} = 50\text{ Hz}$ , $f_{sw} = 5000\text{ Hz}$ , $T_{inlet} = 40^{\circ}\text{C}$ , $T_j \leq 125^{\circ}\text{C}$	$P_{loss}$		1975		W

### Notes

Maximum junction temperature limited to  $125^{\circ}\text{C}$  under all operating conditions

prepared by: OW	date of publication: 2013-10-18
approved by: AR	revision: 2.2

# Technical Information

PrimeSTACK™

# 6PS04512E43G37986



## Preliminary data

### Controller interface

Driver and interface board	ref. to separate Application Note		DR210			
			min.	typ.	max.	
Auxiliary voltage		$V_{aux}$	18	24	30	V
Auxiliary power requirement	$V_{aux} = 24\text{ V}$	$P_{aux}$			40	W
Digital input level	resistor to GND 10 k $\Omega$ , capacitor to GND 1 nF, logic high = on	$V_{in\ low}$	0		1.5	V
		$V_{in\ high}$	11		15	V
Digital output level	open collector, logic low = no fault, max. 15 mA	$V_{out\ low}$	0		1.5	V
		$V_{out\ high}$		15		V
Analog current sensor output inverter section	load max 5 mA, @ 217 $A_{RMS}$	$V_{IU\ ana2}$ $V_{IV\ ana2}$ $V_{IW\ ana2}$	3.3	3.5	3.7	V
Analog DC link voltage sensor output	load max 5 mA, @ 850 V	$V_{DC\ ana}$	8.3	8.5	8.7	V
Analog temperature sensor output unit 1 (NTC)	load max 5 mA, @ $T_{NTC} = 85\text{ }^{\circ}\text{C}$ , corresponds to $T_j = 115\text{ }^{\circ}\text{C}$ at rated conditions	$V_{Theta\ NTC1}$	10.7	10.9	11.1	V
Over temperature shutdown inverter section	load max 5 mA, @ $T_{NTC} = 87\text{ }^{\circ}\text{C}$	$V_{Error\ OT2}$		11		V

### System data

			min.	typ.	max.	
EMC robustness	according to EN 61800-3 at named interfaces	power	$V_{Burst}$	2		kV
		control	$V_{Burst}$	1		kV
		aux (24V)	$V_{surge}$	1		kV
Storage temperature		$T_{stor}$	-40		80	$^{\circ}\text{C}$
Operational ambient temperature	PCB, DC link capacitor, bus bar, excluding cooling medium	$T_{op\ amb}$	-25		55	$^{\circ}\text{C}$
Cooling air velocity	PCB, DC link capacitor, bus bar, standard atmosphere	$V_{air}$	2			m/s
Humidity	no condensation	Rel. F	0		85	%
Vibration	according to IEC 60721				5	$\text{m/s}^2$
Shock	according to IEC 60721				40	$\text{m/s}^2$
Protection degree			IP00			
Pollution degree			2			
Dimensions	width x depth x height		216	335	376	mm
Weight				18		kg

#### Notes

Dimension "depth" does not include the data cables

### Heatsink air cooled

			min.	typ.	max.	
Air flow	$T_{air} = 25\text{ }^{\circ}\text{C}$ , $P_{air} = 1013\text{ hPa}$ , dry and dust free, measured at the side of the heat sink according to DIN 41882	$\Delta V/\Delta t$		500		$\text{m}^3/\text{h}$
Air pressure drop	at min. air flow	$\Delta p$		190		Pa
Air inlet temperature		$T_{inlet}$	-40		55	$^{\circ}\text{C}$

prepared by: OW	date of publication: 2013-10-18
approved by: AR	revision: 2.2

# Technical Information

PrimeSTACK™

# 6PS04512E43G37986



## Preliminary data

### Overview of optional components

	Unit 1	Inverter Section	Unit 3
Parallel interface board			
Optical interface board			
Chopper controller			
Voltage sensor		x	
Current sensor		x	
Temperature sensor		x	
Temperature simulation			
DC link capacitors		x	
Data cable for control signals			
Fan			
Collector-emitter Active Clamping		x	

#### Notes

Setting of Active Clamping TVS-Diodes:  $V_Z = 824 \text{ V}$

prepared by: OW	date of publication: 2013-10-18
approved by: AR	revision: 2.2



## Preliminary data

$f_{AC\ sine}$  - derating curve IGBT (motor), Diode (generator)  
 $V_{DC} = 750\ V$ ,  $V_{AC} = 400\ V_{RMS}$ ,  $f_{sw} = 5\ kHz$ ,  $\cos\phi = \pm 0.8$ ,  
 $T_{inlet} = 40\ ^\circ C$  and nom. cooling conditions

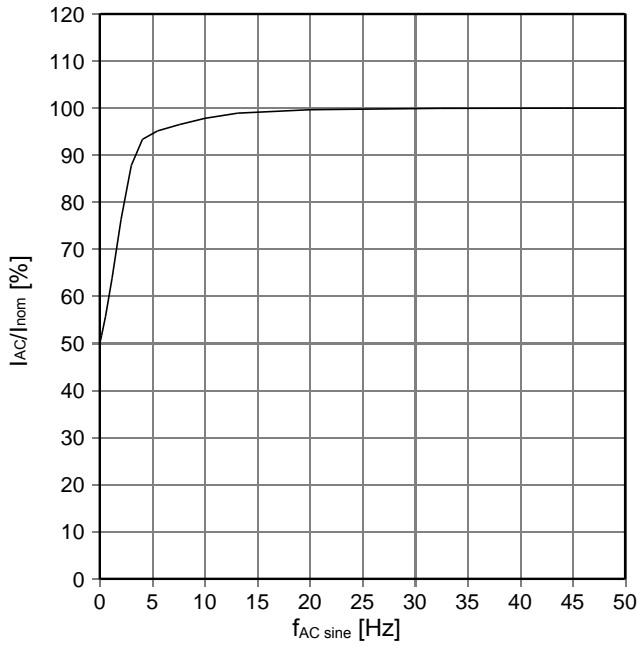

$f_{sw}$  - derating curve IGBT (motor), Diode (generator)  
 $V_{DC} = 750\ V$ ,  $V_{AC} = 400\ V_{RMS}$ ,  $f_{AC\ sine} = 50\ Hz$ ,  $\cos\phi = \pm 0.8$ ,  
 $T_{inlet} = 40\ ^\circ C$  and nom. cooling conditions

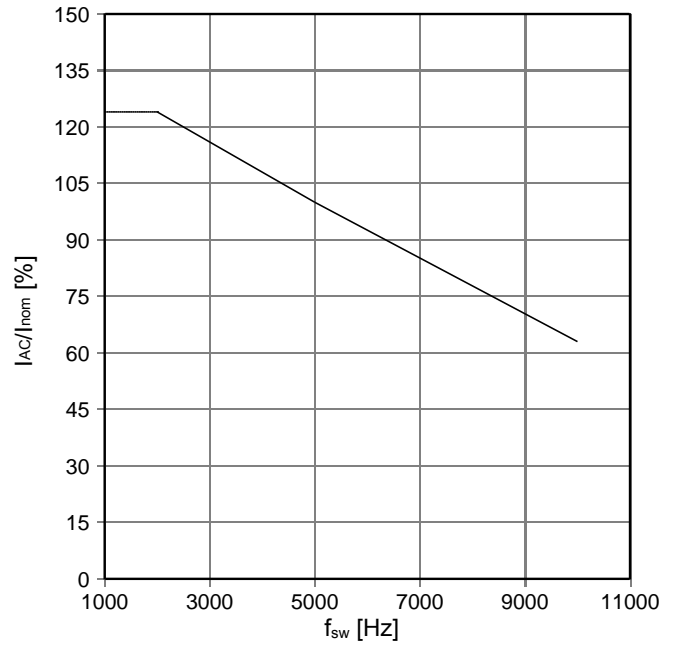

$T_{inlet}$  - derating curve IGBT (motor), Diode (generator)  
 $V_{DC} = 750\ V$ ,  $V_{AC} = 400\ V_{RMS}$ ,  $f_{sw} = 5\ kHz$ ,  $f_{AC\ sine} = 50\ Hz$ ,  
 $\cos\phi = \pm 0.8$  and nom. cooling conditions

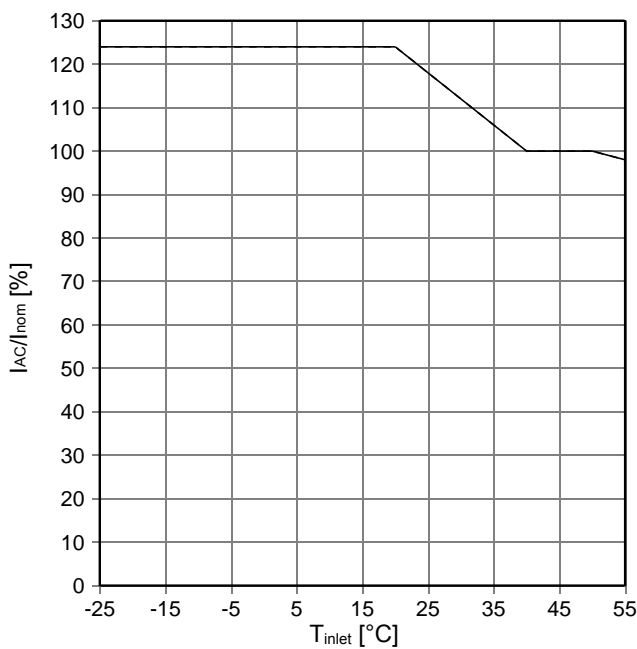

Analog temperature sensor output  $V_{Theta\ NTC}$   
 Sensing NTC of heatsink

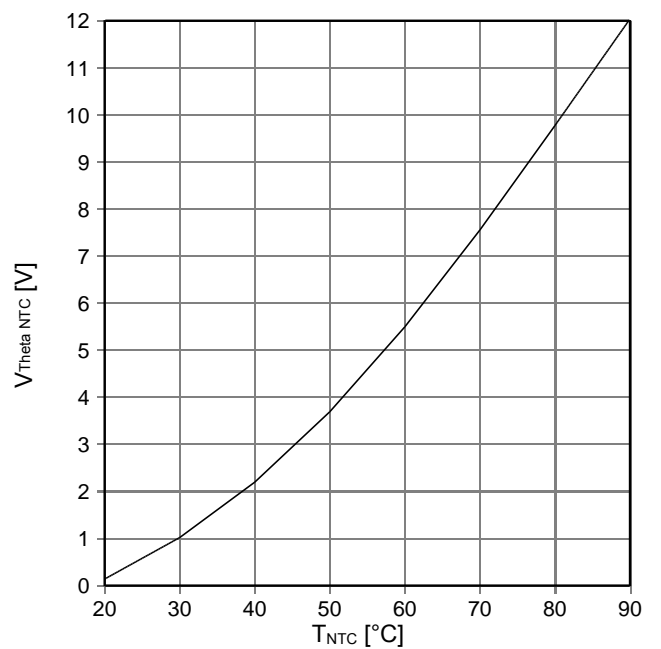

prepared by: OW	date of publication: 2013-10-18
approved by: AR	revision: 2.2

$Z_{th,ha}$  - thermal impedance heatsink to ambient per switch  
nom. cooling conditions

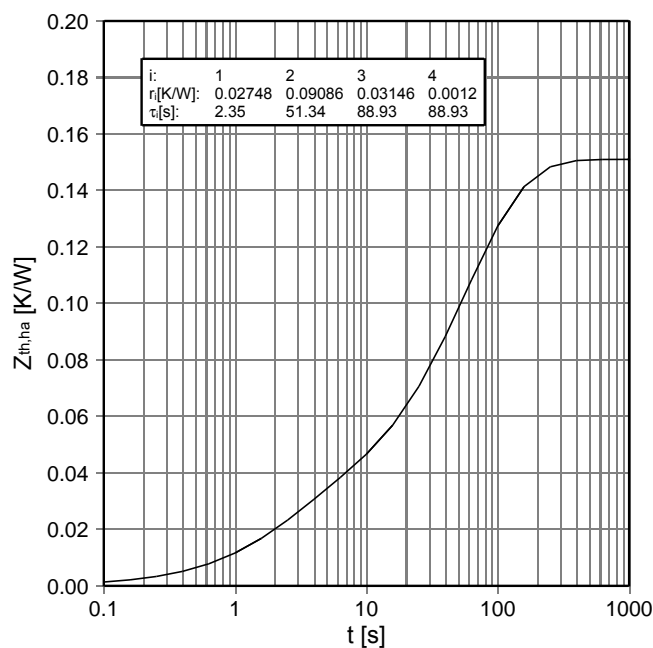

prepared by: OW	date of publication: 2013-10-18
approved by: AR	revision: 2.2

Mechanical drawing

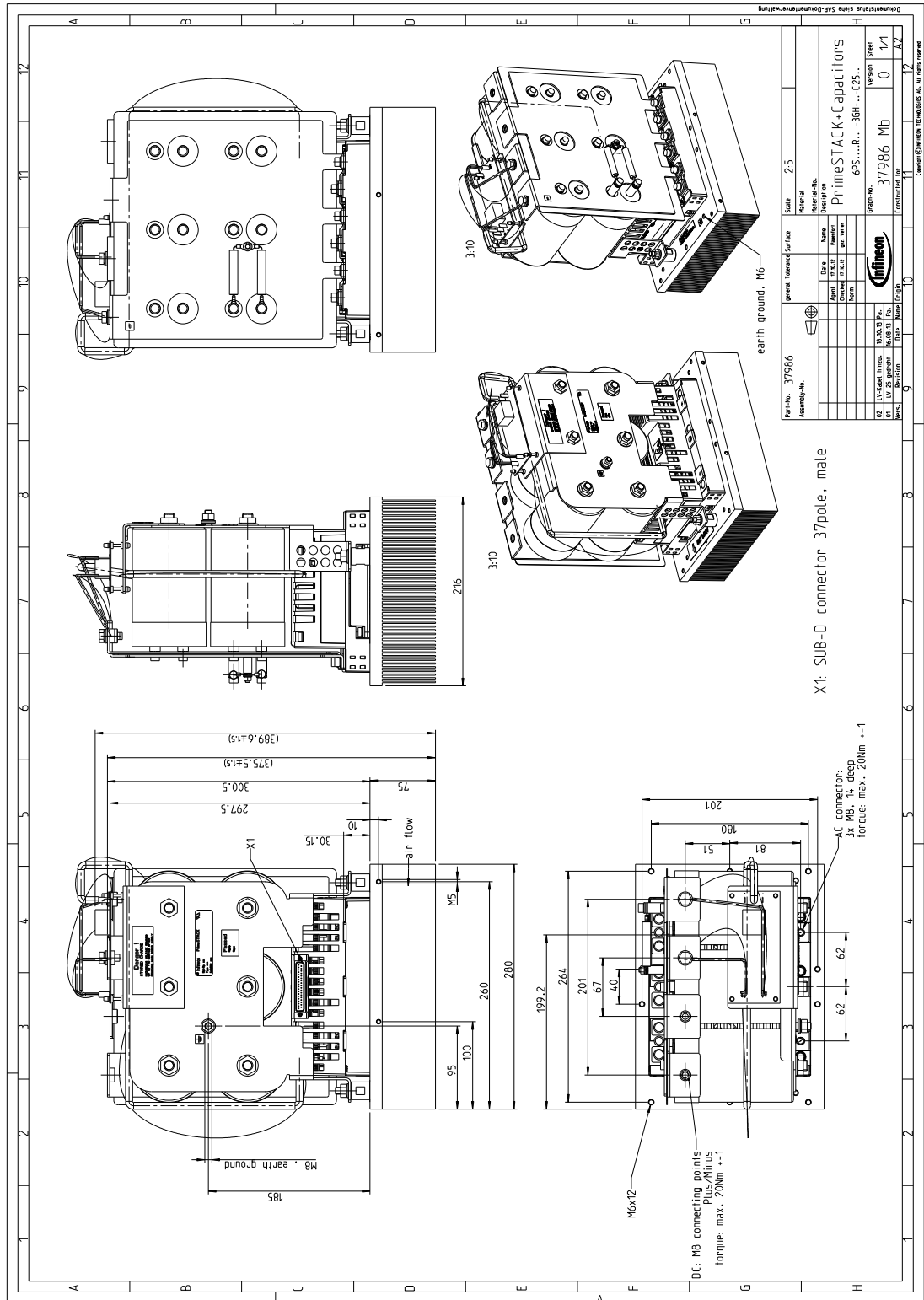

X1: SUB-D connector 37pole, male

AC connector:  
3x M8, 14 deep  
torque: max. 20Nm +-1

M6x12  
DC: M8 connecting points  
PLUS/MINUS  
torque: max. 20Nm +-1

prepared by: OW	date of publication: 2013-10-18
approved by: AR	revision: 2.2

Circuit diagram

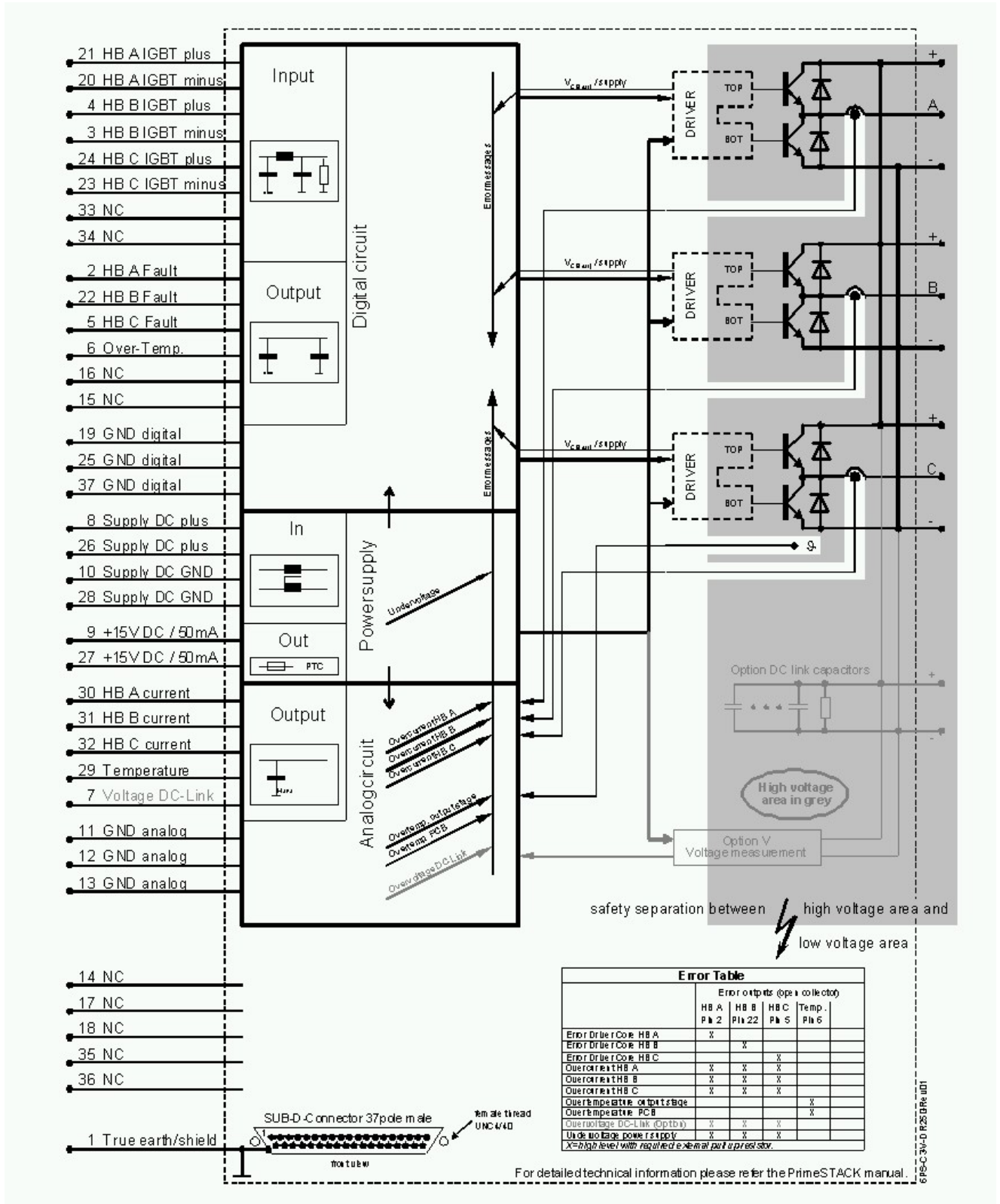

prepared by: OW	date of publication: 2013-10-18
approved by: AR	revision: 2.2



# Technical Information

PrimeSTACK™

# 6PS04512E43G37986



Preliminary data

## Terms & Conditions of usage

The data contained in this product data sheet is exclusively intended for technically trained staff. You and your technical departments will have to evaluate the suitability of the product for the intended application and the completeness of the product data with respect to such application.

This product data sheet is describing the characteristics of this product for which a warranty is granted. Any such warranty is granted exclusively pursuant the terms and conditions of the supply agreement. There will be no guarantee of any kind for the product and its characteristics.

Should you require product information in excess of the data given in this product data sheet or which concerns the specific application of our product, please contact the sales office, which is responsible for you (see [www.infineon.com](http://www.infineon.com), sales&contact). For those that are specifically interested we may provide application notes.

Due to technical requirements our product may contain dangerous substances. For information on the types in question please contact the sales office, which is responsible for you.

Should you intend to use the Product in aviation applications, in health or live endangering or life support applications, please notify.

Please note, that for any such applications we urgently recommend

- to perform joint Risk and Quality Assessments;
- the conclusion of Quality Agreements;
- to establish joint measures of an ongoing product survey,  
and that we may make delivery depended on the realization  
of any such measures.

If and to the extent necessary, please forward equivalent notices to your customers.

Changes of this product data sheet are reserved.

## Safety Instructions

Prior to installation and operation, all safety notices and warnings and all warning signs attached to the equipment have to be carefully read. Make sure that all warning signs remain in a legible condition and that missing or damaged signs are replaced. To installation and operation, all safety notices and warnings and all warning signs attached to the equipment have to be carefully read. Make sure that all warning signs remain in a legible condition and that missing or damaged signs are replaced.

prepared by: OW	date of publication: 2013-10-18
approved by: AR	revision: 2.2