

# BGA751N7

SiGe Bipolar 3G/3.5G/4G Single-Band LNA

## Data Sheet

Revision 3.1, 2013-01-31

**Edition 2013-01-31**

**Published by  
Infineon Technologies AG  
81726 Munich, Germany**

**© 2013 Infineon Technologies AG  
All Rights Reserved.**

### **Legal Disclaimer**

The information given in this document shall in no event be regarded as a guarantee of conditions or characteristics. With respect to any examples or hints given herein, any typical values stated herein and/or any information regarding the application of the device, Infineon Technologies hereby disclaims any and all warranties and liabilities of any kind, including without limitation, warranties of non-infringement of intellectual property rights of any third party.

### **Information**

For further information on technology, delivery terms and conditions and prices, please contact the nearest Infineon Technologies Office ([www.infineon.com](http://www.infineon.com)).

### **Warnings**

Due to technical requirements, components may contain dangerous substances. For information on the types in question, please contact the nearest Infineon Technologies Office.

Infineon Technologies components may be used in life-support devices or systems only with the express written approval of Infineon Technologies, if a failure of such components can reasonably be expected to cause the failure of that life-support device or system or to affect the safety or effectiveness of that device or system. Life support devices or systems are intended to be implanted in the human body or to support and/or maintain and sustain and/or protect human life. If they fail, it is reasonable to assume that the health of the user or other persons may be endangered.

**BGA751N7 SiGe Bipolar 3G/3.5G/4G Single-Band LNA**

**Revision History: 2013-01-31, Revision 3.1**

**Previous Revision: 2012-10-31, Revision 3.0**

Page	Subjects (major changes since last revision)
37	Footprint recommendation drawing added
38	Marking pattern drawing updated

**Trademarks of Infineon Technologies AG**

AURIX™, C166™, CanPAK™, CIPOS™, CIPURSE™, EconoPACK™, CoolMOS™, CoolSET™, CORECONTROL™, CROSSAVE™, DAVE™, DI-POL™, EasyPIM™, EconoBRIDGE™, EconoDUAL™, EconoPIM™, EconoPACK™, EiceDRIVER™, eupec™, FCOS™, HITFET™, HybridPACK™, I<sup>2</sup>RF™, ISOFACE™, IsoPACK™, MIPAQ™, ModSTACK™, my-d™, NovalithIC™, OptiMOS™, ORIGA™, POWERCODE™, PRIMARION™, PrimePACK™, PrimeSTACK™, PRO-SIL™, PROFET™, RASIC™, ReverSave™, SatRIC™, SIEGET™, SINDRION™, SIPMOS™, SmartLEWIS™, SOLID FLASH™, TEMPFET™, thinQ!™, TRENCHSTOP™, TriCore™.

**Other Trademarks**

Advance Design System™ (ADS) of Agilent Technologies, AMBA™, ARM™, MULTI-ICET™, KEIL™, PRIMECELL™, REALVIEW™, THUMB™, μVision™ of ARM Limited, UK. AUTOSAR™ is licensed by AUTOSAR development partnership. Bluetooth™ of Bluetooth SIG Inc. CAT-iq™ of DECT Forum. COLOSSUS™, FirstGPS™ of Trimble Navigation Ltd. EMV™ of EMVCo, LLC (Visa Holdings Inc.). EPCOS™ of Epcos AG. FLEXGO™ of Microsoft Corporation. FlexRay™ is licensed by FlexRay Consortium. HYPERTERMINAL™ of Hilgraeve Incorporated. IEC™ of Commission Electrotechnique Internationale. IrDA™ of Infrared Data Association Corporation. ISO™ of INTERNATIONAL ORGANIZATION FOR STANDARDIZATION. MATLAB™ of MathWorks, Inc. MAXIM™ of Maxim Integrated Products, Inc. MICROTEC™, NUCLEUS™ of Mentor Graphics Corporation. MIPI™ of MIPI Alliance, Inc. MIPS™ of MIPS Technologies, Inc., USA. muRata™ of MURATA MANUFACTURING CO., MICROWAVE OFFICE™ (MWO) of Applied Wave Research Inc., OmniVision™ of OmniVision Technologies, Inc. Openwave™ Openwave Systems Inc. RED HAT™ Red Hat, Inc. RFMD™ RF Micro Devices, Inc. SIRIUS™ of Sirius Satellite Radio Inc. SOLARIS™ of Sun Microsystems, Inc. SPANSION™ of Spansion LLC Ltd. Symbian™ of Symbian Software Limited. TAIYO YUDEN™ of Taiyo Yuden Co. TEAKLITE™ of CEVA, Inc. TEKTRONIX™ of Tektronix Inc. TOKO™ of TOKO KABUSHIKI KAISHA TA. UNIX™ of X/Open Company Limited. VERILOG™, PALLADIUM™ of Cadence Design Systems, Inc. VLYNQ™ of Texas Instruments Incorporated. VXWORKS™, WIND RIVER™ of WIND RIVER SYSTEMS, INC. ZETEX™ of Diodes Zetex Limited.

Last Trademarks Update 2011-11-11

## Table of Contents

	<b>Table of Contents</b> .....	4
	<b>List of Figures</b> .....	5
	<b>List of Tables</b> .....	6
<b>1</b>	<b>Features</b> .....	7
<b>2</b>	<b>Electrical Characteristics</b> .....	9
2.1	Absolute Maximum Ratings .....	9
2.2	Thermal Resistance .....	9
2.3	ESD Integrity .....	9
2.4	DC Characteristics .....	10
2.5	Gain Mode Select Truth Table .....	10
2.6	Switching Times .....	10
2.7	Supply Current Characteristics .....	11
2.8	Logic Signal Characteristics .....	12
2.9	Measured RF Characteristics 700 MHz Band .....	13
2.10	Measured RF Characteristics 750 MHz Band .....	14
2.11	Measured RF Characteristics 800 MHz Band .....	15
2.12	Measured RF Characteristics 880 MHz Band .....	16
2.13	Measured RF Characteristics 900 MHz band .....	17
2.14	Measured RF Characteristics 1100 MHz band .....	18
2.15	Measured Performance Band 13 Application High Gain Mode vs. Frequency .....	19
2.16	Measured Performance Band 13 Application High Gain Mode vs. Temperature .....	20
2.17	Measured Performance Band 13 Application Low Gain Mode vs. Frequency .....	21
2.18	Measured Performance Band 13 Application Low Gain Mode vs. Temperature .....	22
2.19	Measured Performance Band 5 Application High Gain Mode vs. Frequency .....	23
2.20	Measured Performance Band 5 Application High Gain Mode vs. Temperature .....	25
2.21	Measured Performance Band 5 Application Low Gain Mode vs. Frequency .....	26
2.22	Measured Performance Band 5 Application Low Gain Mode vs. Temperature .....	28
<b>3</b>	<b>Application Circuit and Block Diagram</b> .....	29
3.1	700 MHz Band Application Circuit Schematic .....	29
3.2	750 MHz Band Application Circuit Schematic .....	30
3.3	800 MHz Band Application Circuit Schematic .....	31
3.4	880 MHz Band Application Circuit Schematic .....	32
3.5	900 MHz Band Application Circuit Schematic .....	33
3.6	1100 MHz Band Application Circuit Schematic .....	34
3.7	Pin Definition .....	34
3.8	Application Board .....	35
<b>4</b>	<b>Physical Characteristics</b> .....	37
4.1	Package Footprint .....	37
4.2	Package Dimensions .....	38
4.3	Product Marking Pattern .....	38

## List of Figures

Figure 1	Block Diagram of Single-Band LNA . . . . .	8
Figure 2	Application Circuit with Chip Outline (top view) . . . . .	29
Figure 3	Application Circuit with Chip Outline (top view) . . . . .	30
Figure 4	Application Circuit with Chip Outline (top view) . . . . .	31
Figure 5	Application Circuit with Chip Outline (top view) . . . . .	32
Figure 6	Application Circuit with Chip Outline (top view) . . . . .	33
Figure 7	Application Circuit with Chip Outline (top view) . . . . .	34
Figure 8	Application Board Layout on 3-layer FR4 . . . . .	35
Figure 9	Cross-Section view of Application Board . . . . .	35
Figure 10	Detail of Application Board Layout . . . . .	36
Figure 11	Footprint Recommendation 1 for the TSNP-7-1 Package . . . . .	37
Figure 12	Footprint Recommendation 2 for the TSNP-7-1 Package . . . . .	37
Figure 13	Package Outline (top, side and bottom view) . . . . .	38
Figure 14	Tape & Reel Dimensions . . . . .	38
Figure 15	Marking Pattern (top view) . . . . .	38

## List of Tables

Table 1	Absolute Maximum Ratings .....	9
Table 2	Thermal Resistance .....	9
Table 3	ESD Integrity .....	9
Table 4	DC Characteristics, $T_A = 25\text{ °C}$ .....	10
Table 5	Truth Table .....	10
Table 6	Typical switching times; $T_A = -30 \dots 85\text{ °C}$ .....	10
Table 7	Typical Characteristics 700 MHz Band, $T_A = 25\text{ °C}$ , $V_{CC} = 2.8\text{ V}$ , $R_{REF} = 5.6\text{ k}\Omega$ .....	13
Table 8	Typical Characteristics 750 MHz Band, $T_A = 25\text{ °C}$ , $V_{CC} = 2.8\text{ V}$ , $R_{REF} = 5.6\text{ k}\Omega$ .....	14
Table 9	Typical Characteristics 800 MHz Band, $T_A = 25\text{ °C}$ , $V_{CC} = 2.8\text{ V}$ , $R_{REF} = 5.6\text{ k}\Omega$ .....	15
Table 10	Typical Characteristics 880 MHz Band, $T_A = 25\text{ °C}$ , $V_{CC} = 2.8\text{ V}$ , $R_{REF} = \text{n/c}$ .....	16
Table 11	Typical Characteristics 900 MHz Band, $T_A = 25\text{ °C}$ , $V_{CC} = 2.8\text{ V}$ , $R_{REF} = \text{n/c}$ .....	17
Table 12	Typical Characteristics 1100 MHz Band, $T_A = 25\text{ °C}$ , $V_{CC} = 2.8\text{ V}$ , $R_{REF} = 8.2\text{ k}\Omega$ .....	18
Table 13	Parts List .....	29
Table 14	Parts List .....	30
Table 15	Parts List .....	31
Table 16	Parts List .....	32
Table 17	Parts List .....	33
Table 18	Parts List .....	34
Table 19	Pin Definition and Function .....	34

## 1 Features

Main features:

- Gain: 16 / -8 dB in high / low gain mode (f.e. at 850MHz)
- Noise figure: 1.05 dB in high gain mode (f.e. at 850MHz)
- Supply current: 3.3 / 0.5 mA in high / low gain mode
- Standby mode (< 2  $\mu$ A typ.)
- Output internally matched to 50  $\Omega$
- Inputs pre-matched to 50  $\Omega$
- 2 kV HBM ESD protection
- Low external component count
- Small leadless TSNP-7-1 package (2.0 x 1.3 x 0.39 mm)
- Pb-free (RoHS compliant) package

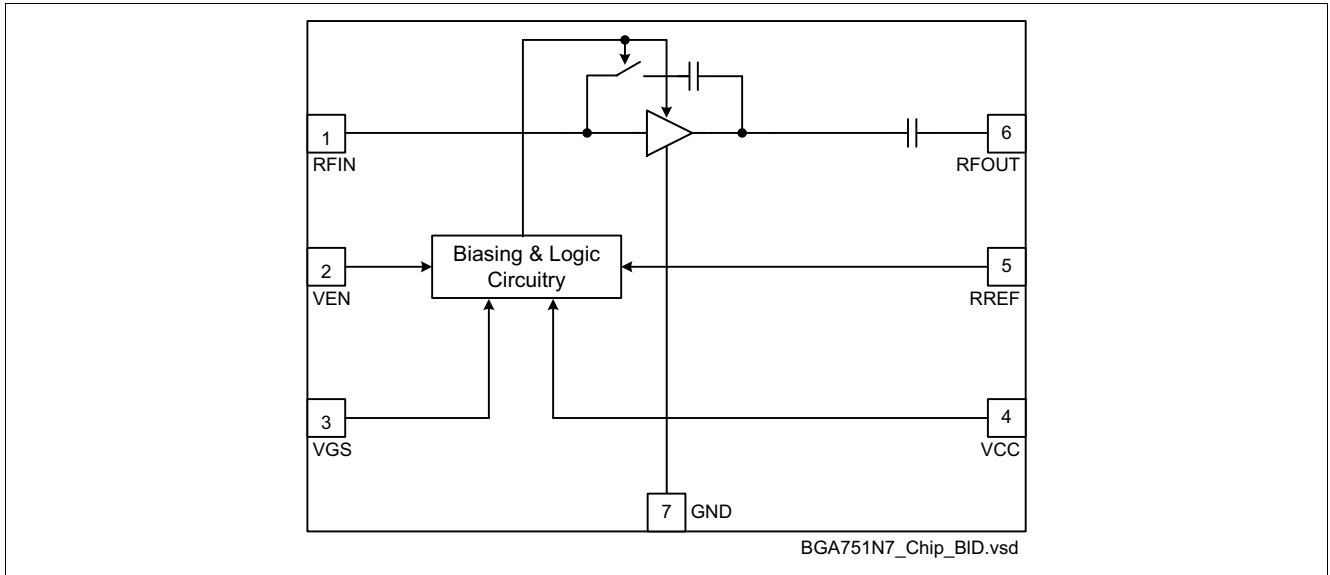


### Description

The BGA751N7 is a low current single-band low noise amplifier MMIC for 3G, 3.5G and 4G. The LNA is based upon Infineon's proprietary and cost-effective SiGe:C technology and comes in a low profile TSNP-7-1 leadless green package. Because the matching is off chip, the RFpath can be easily converted into a 700MHz to 1150MHz path by optimizing the input and output matching network. This document specifies the electrical parameters, pinout, application circuit and packaging of the chip.



Product Name	Package	Chip	Marking
BGA751N7	TSNP-7-1	T1533	B5



**Figure 1** Block Diagram of Single-Band LNA



## 2 Electrical Characteristics

### 2.1 Absolute Maximum Ratings

**Table 1 Absolute Maximum Ratings**

Parameter	Symbol	Values			Unit	Note / Test Condition
		Min.	Typ.	Max.		
Supply voltage	$V_{CC}$	-0.3	–	3.6	V	–
Supply current	$I_{CC}$	–	–	10	mA	–
Pin voltage	$V_{PIN}$	-0.3	–	$V_{CC}+0.3$	V	All pins except RF input pins.
Pin voltage RF Input Pins	$V_{RFIN}$	-0.3	–	0.9	V	–
RF input power	$P_{RFIN}$	–	–	4	dBm	–
Junction temperature	$T_j$	–	–	150	°C	–
Ambient temperature range	$T_A$	-30	–	85	°C	–
Storage temperature range	$T_{stg}$	-65	–	150	°C	–

**Attention: Stresses above the max. values listed here may cause permanent damage to the device. Exposure to absolute maximum rating conditions for extended periods may affect device reliability. Maximum ratings are absolute ratings; exceeding only one of these values may cause irreversible damage to the integrated circuit.**

### 2.2 Thermal Resistance

**Table 2 Thermal Resistance**

Parameter	Symbol	Values			Unit	Note / Test Condition
		Min.	Typ.	Max.		
Thermal resistance junction to soldering point	$R_{thJS}$	–	150	–	K/W	–

### 2.3 ESD Integrity

**Table 3 ESD Integrity**

Parameter	Symbol	Values			Unit	Note / Test Condition
		Min.	Typ.	Max.		
ESD hardness HBM <sup>1)</sup>	$V_{ESD-HBM}$	–	2000	–	V	All pins

1) According to JESD22-A114

## 2.4 DC Characteristics

**Table 4 DC Characteristics,  $T_A = 25\text{ °C}$**

Parameter	Symbol	Values			Unit	Note / Test Condition
		Min.	Typ.	Max.		
Supply voltage	$V_{CC}$	2.6	2.8	3.0	V	–
Supply current high gain mode	$I_{CCHG}$	–	3.3	–	mA	Typical value without reference resistor
Supply current low gain mode	$I_{CCLG}$	–	0.5	–	mA	
Supply current standby mode	$I_{CCOFF}$	–	0.1	2.0	$\mu\text{A}$	–
Logic level high	$V_{HI}$	1.4	2.8	–	V	All logic pins
Logic level low	$V_{LO}$	-0.2	0.0	0.5	V	
Logic currents	$I_{LO}$	–	–	0.1	$\mu\text{A}$	All logic pins
	$I_{HI}$	–	5.0	6.0	$\mu\text{A}$	

## 2.5 Gain Mode Select Truth Table

**Table 5 Truth Table**

Control Voltage		State	
		All Bands	
VEN	VGS	HG	LG
H	L	OFF	ON
H	H	ON	OFF
L	L	STANDBY <sup>1)</sup>	
L	H		

1) In order to achieve minimum standby current it is encouraged to apply logic low-level at the VGS pin in standby mode although this is not mandatory. Details see section 2.4.

## 2.6 Switching Times

**Table 6 Typical switching times;  $T_A = -30 \dots 85\text{ °C}$**

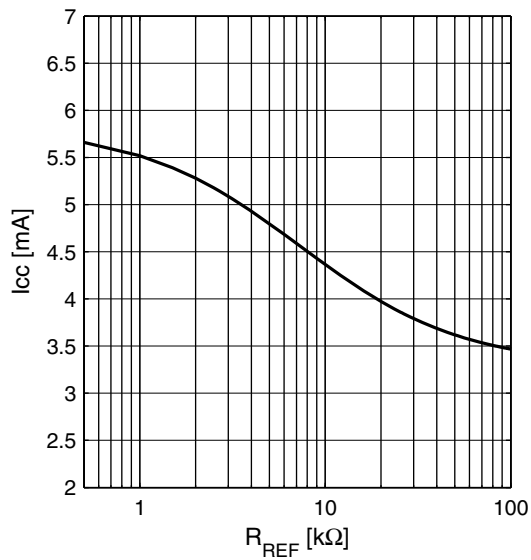
Parameter	Symbol	Values			Unit	Note / Test Condition
		Min.	Typ.	Max.		
Settling time gainstep	$t_{GS}$	–	1	–	$\mu\text{s}$	Switching LG $\leftrightarrow$ HG

## 2.7 Supply Current Characteristics

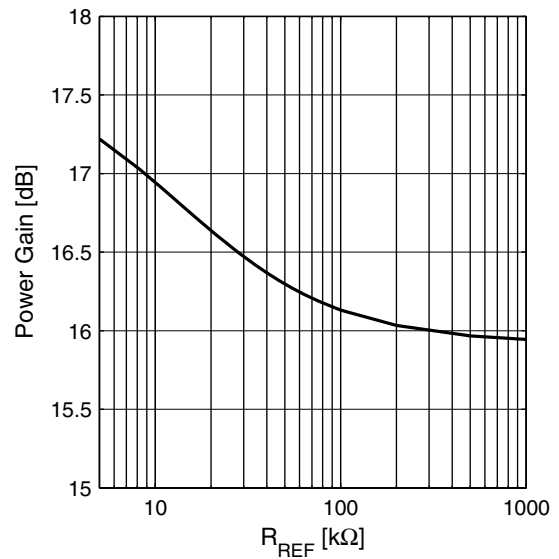
Supply current and Power gain high gain mode versus reference resistor  $R_{REF}$  (low gain mode supply current is independent of reference resistor).

*Note: In order to achieve higher gain an external reference resistor can be soldered between RREF (Pin 5) and ground (see Figure 3.4 on Page 32).*

**Supply Current**  $I_{CC} = f(R_{REF})$   
 $V_{CC} = 2.8 \text{ V}$ ,  $T_A = 25 \text{ }^\circ\text{C}$



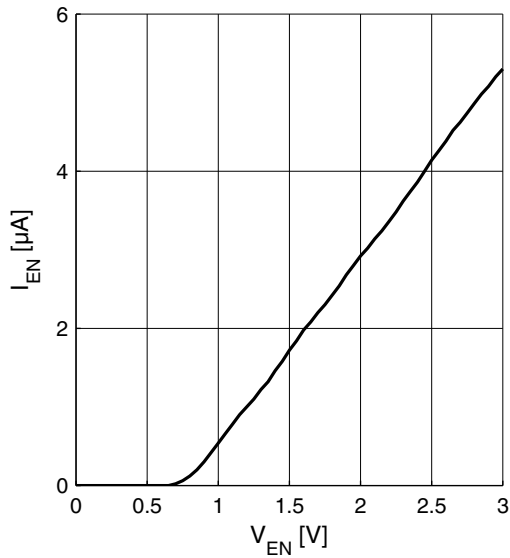
**Power Gain**  $|S_{21}| = f(R_{REF})$   
 $V_{CC} = 2.8 \text{ V}$ ,  $T_A = 25 \text{ }^\circ\text{C}$



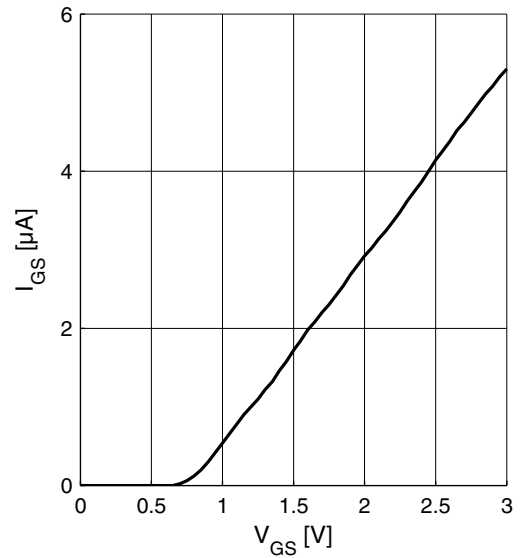
## 2.8 Logic Signal Characteristics

Current consumption of logic inputs VEN, VGS

**Logic Current  $I_{EN} = f(V_{EN})$**   
 $V_{CC} = 2.8 \text{ V}$ ,  $T_A = 25 \text{ }^\circ\text{C}$



**Logic Current  $I_{GS} = f(V_{GS})$**   
 $V_{CC} = 2.8 \text{ V}$ ,  $T_A = 25 \text{ }^\circ\text{C}$



## 2.9 Measured RF Characteristics 700 MHz Band

**Table 7** Typical Characteristics 700 MHz Band,  $T_A = 25\text{ °C}$ ,  $V_{CC} = 2.8\text{ V}$ ,  $R_{REF} = 5.6\text{ k}\Omega$ <sup>1)2)</sup>

Parameter	Symbol	Values			Unit	Note / Test Condition
		Min.	Typ.	Max.		
Pass band range		700		750	MHz	F.e. band 12 and 17
Current consumption	$I_{CCHG}$	–	4.8	–	mA	High gain mode
	$I_{CCLG}$	–	0.50	–	mA	Low gain mode
Gain	$S_{21HG}$	–	15.3	–	dB	High gain mode
	$S_{21LG}$	–	-9.9	–	dB	Low gain mode
Reverse isolation	$S_{12HG}$	–	-40	–	dB	High gain mode
	$S_{12LG}$	–	-9.9	–	dB	Low gain mode
Noise figure	$NF_{HG}$	–	1.1	–	dB	High gain mode
	$NF_{LG}$	–	9.9	–	dB	Low gain mode
Input return loss	$S_{11HG}$	–	-13	–	dB	50 $\Omega$ , high gain mode
	$S_{11LG}$	–	-14	–	dB	50 $\Omega$ , low gain mode
Output return loss	$S_{22HG}$	–	-27	–	dB	50 $\Omega$ , high gain mode
	$S_{22LG}$	–	-19	–	dB	50 $\Omega$ , low gain mode
Stability factor	$k$	–	>2.2	–		DC to 8 GHz; all gain modes
Input compression point	$IP_{1dBHG}$	–	-7	–	dBm	High gain mode
	$IP_{1dBLG}$	–	-12	–	dBm	Low gain mode
Inband IIP3 $f_1 - f_2 = 1\text{ MHz}$	$IIP3_{HG}$	–	-8	–	dBm	High gain mode
	$IIP3_{LG}$	–	-2	–	dBm	Low gain mode

1) Performance based on application circuit in Figure 3.1 on Page 29

2) Guaranteed by device design; not tested in production

## 2.10 Measured RF Characteristics 750 MHz Band

**Table 8** Typical Characteristics 750 MHz Band,  $T_A = 25\text{ °C}$ ,  $V_{CC} = 2.8\text{ V}$ ,  $R_{REF} = 5.6\text{ k}\Omega$ <sup>1)2)</sup>

Parameter	Symbol	Values			Unit	Note / Test Condition
		Min.	Typ.	Max.		
Pass band range		740		790	MHz	F.e. band 13 and 14
Current consumption	$I_{CCHG}$	–	4.8	–	mA	High gain mode
	$I_{CCLG}$	–	0.50	–	mA	Low gain mode
Gain	$S_{21HG}$	–	15.5	–	dB	High gain mode
	$S_{21LG}$	–	-9.8	–	dB	Low gain mode
Reverse isolation	$S_{12HG}$	–	-39	–	dB	High gain mode
	$S_{12LG}$	–	-9.8	–	dB	Low gain mode
Noise figure	$NF_{HG}$	–	1.1	–	dB	High gain mode
	$NF_{LG}$	–	9.8	–	dB	Low gain mode
Input return loss	$S_{11HG}$	–	-15	–	dB	50 $\Omega$ , high gain mode
	$S_{11LG}$	–	-12	–	dB	50 $\Omega$ , low gain mode
Output return loss	$S_{22HG}$	–	-15	–	dB	50 $\Omega$ , high gain mode
	$S_{22LG}$	–	-20	–	dB	50 $\Omega$ , low gain mode
Stability factor	$k$	–	>2.3	–		DC to 8 GHz; all gain modes
Input compression point	$IP_{1dBHG}$	–	-7	–	dBm	High gain mode
	$IP_{1dBLG}$	–	-11	–	dBm	Low gain mode
Inband IIP3 $f_1 - f_2 = 1\text{ MHz}$	$IIP3_{HG}$	–	-7	–	dBm	High gain mode
	$IIP3_{LG}$	–	-2	–	dBm	Low gain mode

1) Performance based on application circuit in Figure 3.2 on Page 30

2) Guaranteed by device design; not tested in production

## 2.11 Measured RF Characteristics 800 MHz Band

**Table 9** Typical Characteristics 800 MHz Band,  $T_A = 25\text{ °C}$ ,  $V_{CC} = 2.8\text{ V}$ ,  $R_{REF} = 5.6\text{ k}\Omega$ <sup>1)2)</sup>

Parameter	Symbol	Values			Unit	Note / Test Condition
		Min.	Typ.	Max.		
Pass band range		790		840	MHz	F.e. band 20
Current consumption	$I_{CCHG}$	–	4.8	–	mA	High gain mode
	$I_{CCLG}$	–	0.50	–	mA	Low gain mode
Gain	$S_{21HG}$	–	15.9	–	dB	High gain mode
	$S_{21LG}$	–	-8.4	–	dB	Low gain mode
Reverse isolation	$S_{12HG}$	–	-38	–	dB	High gain mode
	$S_{12LG}$	–	-8.4	–	dB	Low gain mode
Noise figure	$NF_{HG}$	–	1.0	–	dB	High gain mode
	$NF_{LG}$	–	8.4	–	dB	Low gain mode
Input return loss	$S_{11HG}$	–	-16	–	dB	50 $\Omega$ , high gain mode
	$S_{11LG}$	–	-11	–	dB	50 $\Omega$ , low gain mode
Output return loss	$S_{22HG}$	–	-13	–	dB	50 $\Omega$ , high gain mode
	$S_{22LG}$	–	-27	–	dB	50 $\Omega$ , low gain mode
Stability factor	$k$	–	>2.3	–		DC to 8 GHz; all gain modes
Input compression point	$IP_{1dBHG}$	–	-6	–	dBm	High gain mode
	$IP_{1dB LG}$	–	-10	–	dBm	Low gain mode
Inband IIP3 $f_1 - f_2 = 1\text{ MHz}$	$IIP3_{HG}$	–	-8	–	dBm	High gain mode
	$IIP3_{LG}$	–	-1	–	dBm	Low gain mode

1) Performance based on application circuit in Figure 3.3 on Page 31

2) Guaranteed by device design; not tested in production

## 2.12 Measured RF Characteristics 880 MHz Band

**Table 10** Typical Characteristics 880 MHz Band,  $T_A = 25\text{ °C}$ ,  $V_{CC} = 2.8\text{ V}^{1)}$ ,  $R_{REF} = n/c$

Parameter	Symbol	Values			Unit	Note / Test Condition
		Min.	Typ.	Max.		
Pass band range		840	–	900	MHz	F.e. band 5 and 6
Current consumption	$I_{CCHG}$	–	3.3	–	mA	High gain mode
	$I_{CCLG}$	–	0.5	–	mA	Low gain mode
Gain	$S_{21HG}$	–	15.8	–	dB	High gain mode
	$S_{21LG}$	–	-7.7	–	dB	Low gain mode
Reverse Isolation <sup>2)</sup>	$S_{12HG}$	–	-36	–	dB	High gain mode
	$S_{12LG}$	–	-8.0	–	dB	Low gain mode
Noise figure	$NF_{HG}$	–	1.05	–	dB	High gain mode
	$NF_{LG}$	–	7.9	–	dB	Low gain mode
Input return loss <sup>2)</sup>	$S_{11HG}$	–	-21	–	dB	50 $\Omega$ , high gain mode
	$S_{11LG}$	–	-13	–	dB	50 $\Omega$ , low gain mode
Output return loss <sup>2)</sup>	$S_{22HG}$	–	-21	–	dB	50 $\Omega$ , high gain mode
	$S_{22LG}$	–	-13	–	dB	50 $\Omega$ , low gain mode
Stability factor <sup>3)</sup>	$k$	–	>2.3	–		DC to 8 GHz; all gain modes
Input compression point <sup>2)</sup>	$IP_{1dBHG}$	–	-5	–	dBm	High gain mode
	$IP_{1dBLG}$	–	-8	–	dBm	Low gain mode
Inband IIP3 <sup>2)</sup> $f_1 - f_2 = 1\text{ MHz}$	$IIP3_{HG}$	–	-7	–	dBm	High gain mode
	$IIP3_{LG}$	–	1	–	dBm	Low gain mode

1) Performance based on application circuit in Figure 3.4 on Page 32

2) Verification based on AQL; random production test.

3) Guaranteed by device design; not tested in production.



### 2.13 Measured RF Characteristics 900 MHz band

**Table 11 Typical Characteristics 900 MHz Band,  $T_A = 25\text{ °C}$ ,  $V_{CC} = 2.8\text{ V}^{1)2)}$ ,  $R_{REF} = n/c$**

Parameter	Symbol	Values			Unit	Note / Test Condition
		Min.	Typ.	Max.		
Pass band range		900	–	1040	MHz	F.e. band 8
Current consumption	$I_{CCHG}$	–	3.3	–	mA	High gain mode
	$I_{CCLG}$	–	0.5	–	mA	Low gain mode
Gain	$S_{21HG}$	–	15.5	–	dB	High gain mode
	$S_{21LG}$	–	-7.2	–	dB	Low gain mode
Reverse Isolation	$S_{12HG}$	–	-36	–	dB	High gain mode
	$S_{12LG}$	–	-7.0	–	dB	Low gain mode
Noise figure	$NF_{HG}$	–	1.15	–	dB	High gain mode
	$NF_{LG}$	–	7.7	–	dB	Low gain mode
Input return loss	$S_{11HG}$	–	-12	–	dB	50 $\Omega$ , high gain mode
	$S_{11LG}$	–	-15	–	dB	50 $\Omega$ , low gain mode
Output return loss	$S_{22HG}$	–	-12	–	dB	50 $\Omega$ , high gain mode
	$S_{22LG}$	–	-12	–	dB	50 $\Omega$ , low gain mode
Stability factor	$k$	–	>2.3	–		DC to 8 GHz; all gain modes
Input compression point	$IP_{1dBHG}$	–	-4	–	dBm	High gain mode
	$IP_{1dBLG}$	–	-5	–	dBm	Low gain mode
Inband IIP3 $f_1 - f_2 = 1\text{ MHz}$	$IIP3_{HG}$	–	-6	–	dBm	High gain mode
	$IIP3_{LG}$	–	1	–	dBm	Low gain mode

1) Performance based on application circuit in Figure 3.5 on Page 33

2) Guaranteed by device design; not tested in production.

## 2.14 Measured RF Characteristics 1100 MHz band

**Table 12** Typical Characteristics 1100 MHz Band,  $T_A = 25\text{ °C}$ ,  $V_{CC} = 2.8\text{ V}^{1)2)}$ ,  $R_{REF} = 8.2\text{ k}\Omega$

Parameter	Symbol	Values			Unit	Note / Test Condition
		Min.	Typ.	Max.		
Pass band range		1040	–	1150	MHz	–
Current consumption	$I_{CCHG}$	–	4.3	–	mA	High gain mode
	$I_{CCLG}$	–	0.5	–	mA	Low gain mode
Gain	$S_{21HG}$	–	16.2	–	dB	High gain mode
	$S_{21LG}$	–	-7.0	–	dB	Low gain mode
Reverse Isolation	$S_{12HG}$	–	-36	–	dB	High gain mode
	$S_{12LG}$	–	-7.0	–	dB	Low gain mode
Noise figure	$NF_{HG}$	–	1.2	–	dB	High gain mode
	$NF_{LG}$	–	7.0	–	dB	Low gain mode
Input return loss	$S_{11HG}$	–	-15	–	dB	50 $\Omega$ , high gain mode
	$S_{11LG}$	–	-10	–	dB	50 $\Omega$ , low gain mode
Output return loss	$S_{22HG}$	–	-15	–	dB	50 $\Omega$ , high gain mode
	$S_{22LG}$	–	-11	–	dB	50 $\Omega$ , low gain mode
Stability factor	$k$	–	>2.3	–		DC to 8 GHz; all gain modes
Input compression point	$IP_{1dBHG}$	–	-5	–	dBm	High gain mode
	$IP_{1dBLG}$	–	-2	–	dBm	Low gain mode
Inband IIP3 $f_1 - f_2 = 1\text{ MHz}$	$IIP3_{HG}$	–	-3	–	dBm	High gain mode
	$IIP3_{LG}$	–	3	–	dBm	Low gain mode

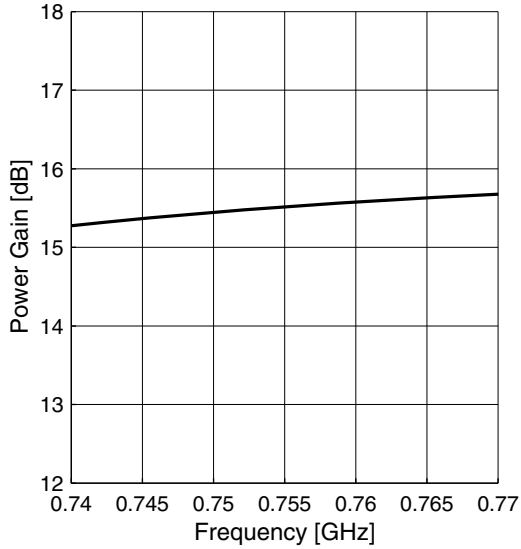
1) Performance based on application circuit in Figure 3.6 on Page 34

2) Guaranteed by device design; not tested in production.

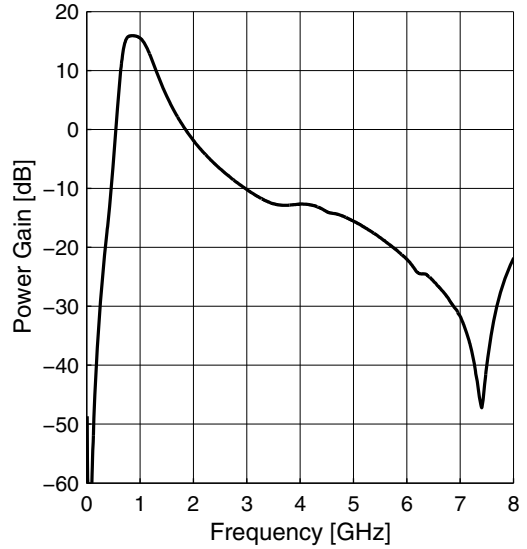
### 2.15 Measured Performance Band 13 Application High Gain Mode vs. Frequency

$T_A = 25\text{ }^\circ\text{C}$ ,  $V_{CC} = 2.8\text{ V}$ ,  $V_{GS} = 2.8\text{ V}$ ,  $V_{EN} = 2.8\text{ V}$ ,  $R_{REF} = 5.6\text{ k}\Omega$

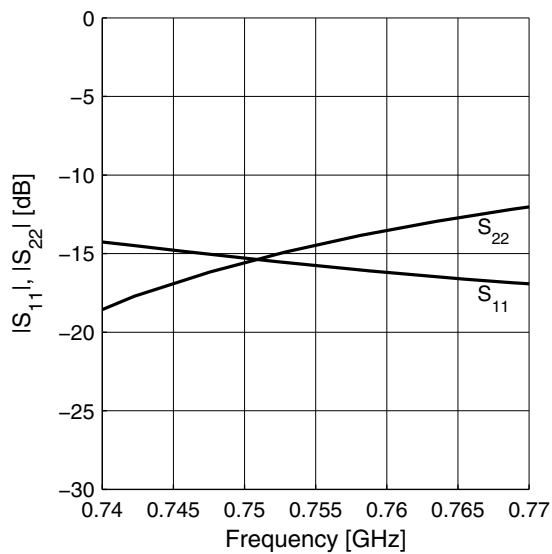
Power Gain  $|S_{21}| = f(f)$



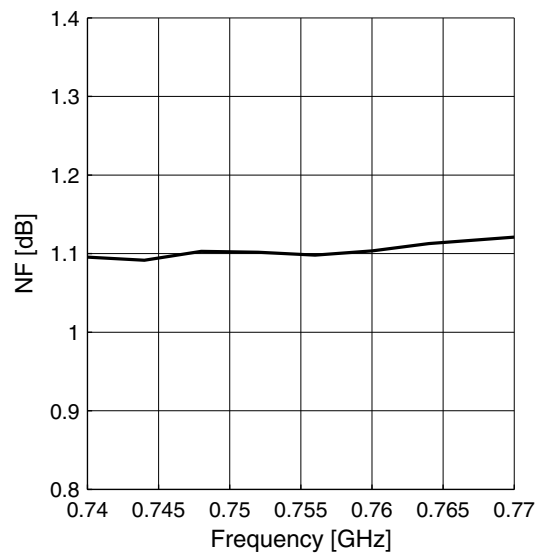
Power Gain wideband  $|S_{21}| = f(f)$



Matching  $|S_{11}| = f(f)$ ,  $|S_{22}| = f(f)$



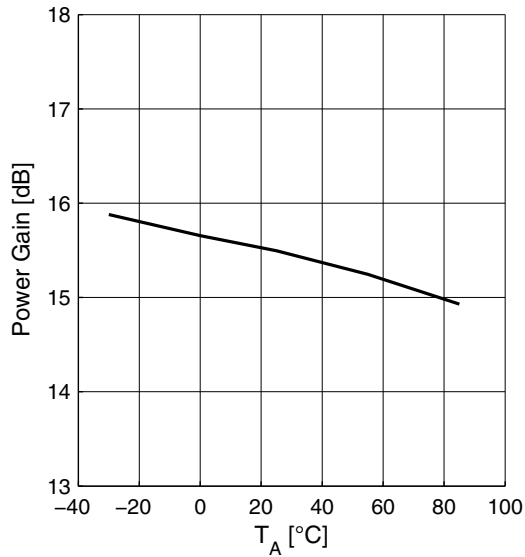
Noise Figure  $NF = f(f)$



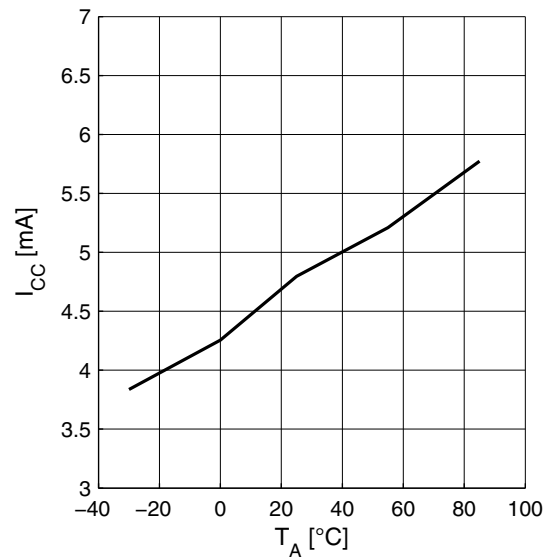
**2.16 Measured Performance Band 13 Application High Gain Mode vs. Temperature**

$V_{CC} = 2.8\text{ V}$ ,  $V_{GS} = 2.8\text{ V}$ ,  $V_{EN} = 2.8\text{ V}$ ,  $f = 750\text{ MHz}$ ,  $R_{REF} = 5.6\text{ k}\Omega$

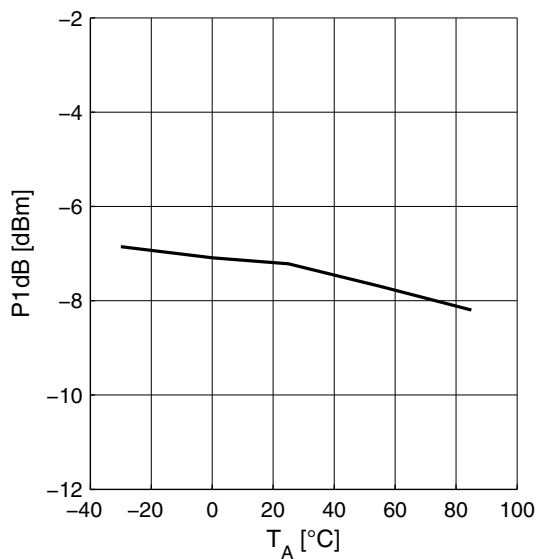
**Power Gain  $|S_{21}| = f(T_A)$**



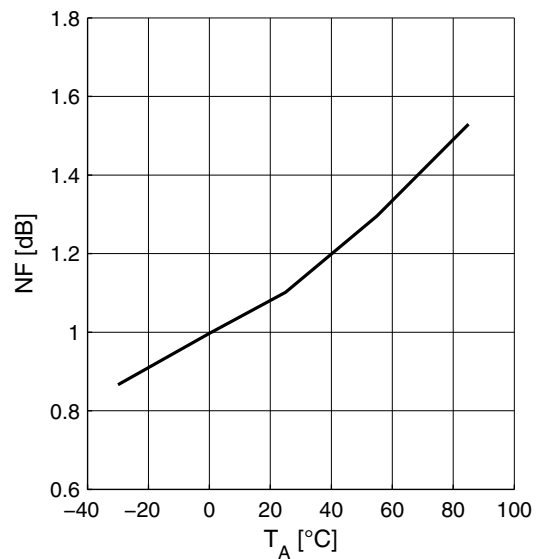
**Supply Current  $I_{CC} = f(T_A)$**



**Input Compression  $P1dB = f(T_A)$**



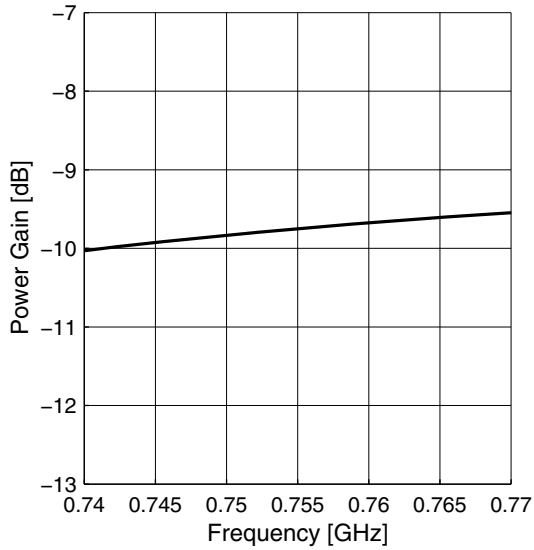
**Noise Figure  $NF = f(T_A)$**



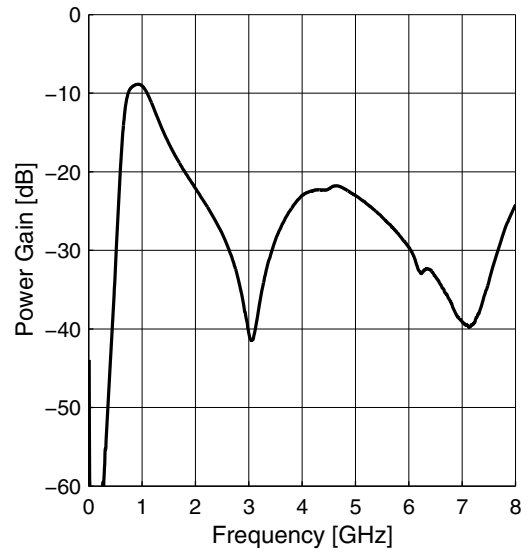
**2.17 Measured Performance Band 13 Application Low Gain Mode vs. Frequency**

$T_A = 25\text{ }^\circ\text{C}$ ,  $V_{CC} = 2.8\text{ V}$ ,  $V_{GS} = 0\text{ V}$ ,  $V_{EN} = 2.8\text{ V}$ ,  $R_{REF} = 5.6\text{ k}\Omega$

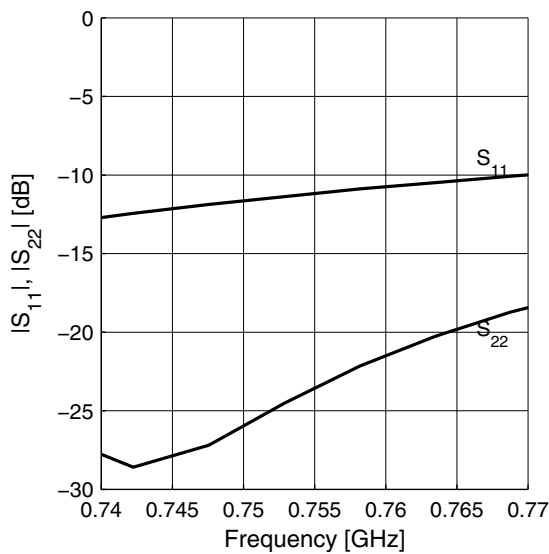
**Power Gain  $|S_{21}| = f(f)$**



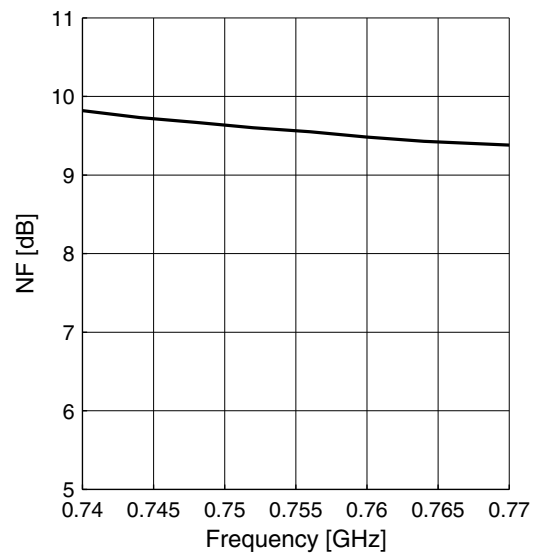
**Power Gain wideband  $|S_{21}| = f(f)$**



**Matching  $|S_{11}| = f(f)$ ,  $|S_{22}| = f(f)$**



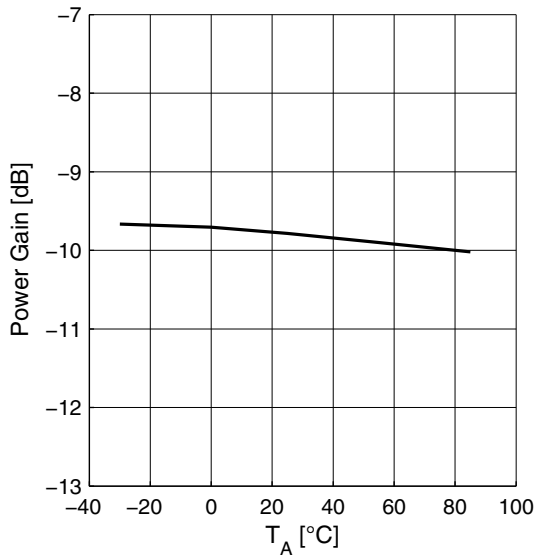
**Noise Figure  $NF = f(f)$**



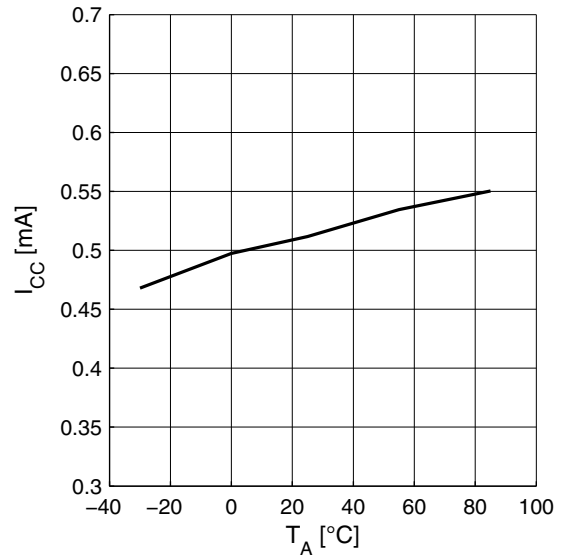
**2.18 Measured Performance Band 13 Application Low Gain Mode vs. Temperature**

$V_{CC} = 2.8\text{ V}$ ,  $V_{GS} = 0\text{ V}$ ,  $V_{EN} = 2.8\text{ V}$ ,  $f = 750\text{ MHz}$ ,  $R_{REF} = 5.6\text{ k}\Omega$

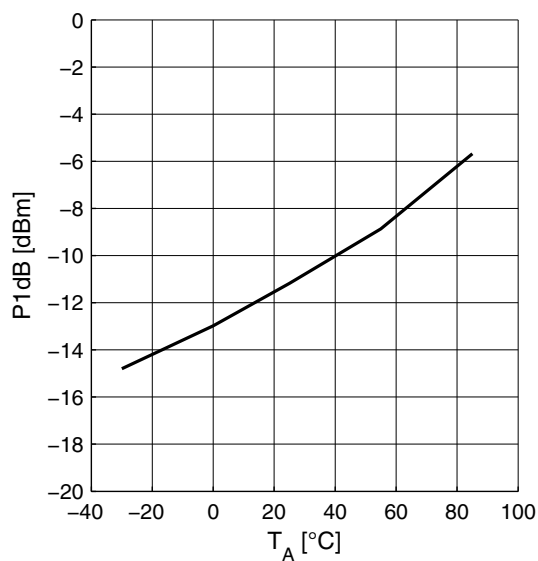
**Power Gain  $|S_{21}| = f(T_A)$**



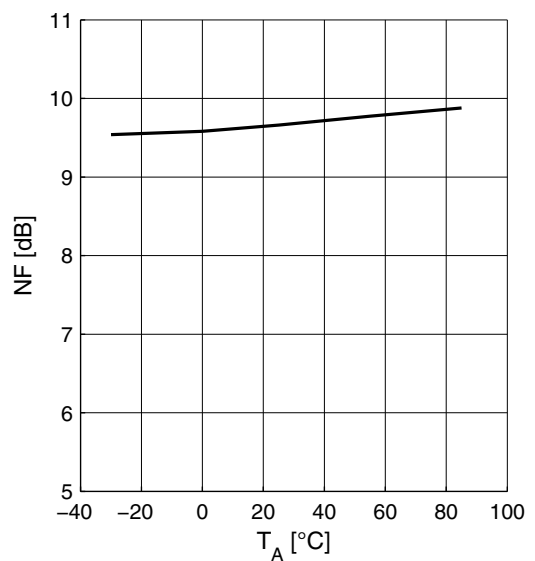
**Supply Current  $I_{CC} = f(T_A)$**



**Input Compression  $P1dB = f(T_A)$**



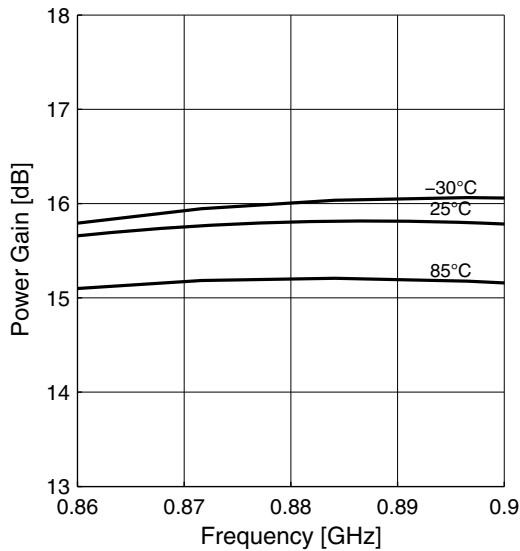
**Noise Figure  $NF = f(T_A)$**



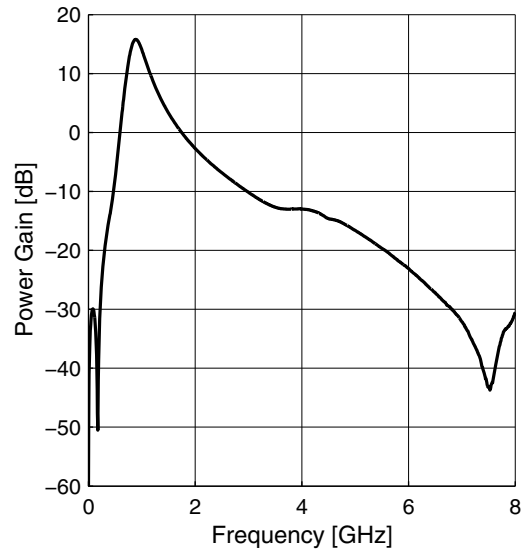
### 2.19 Measured Performance Band 5 Application High Gain Mode vs. Frequency

$T_A = 25\text{ }^\circ\text{C}$ ,  $V_{CC} = 2.8\text{ V}$ ,  $V_{GS} = 2.8\text{ V}$ ,  $V_{EN} = 2.8\text{ V}$ ,  $R_{REF} = n/c$

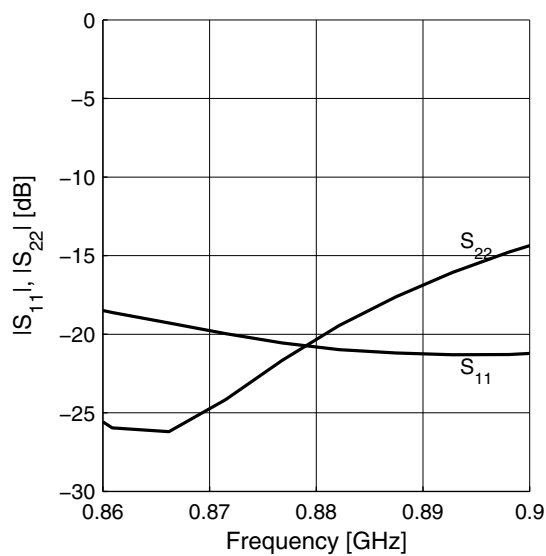
Power Gain  $|S_{21}| = f(f)$



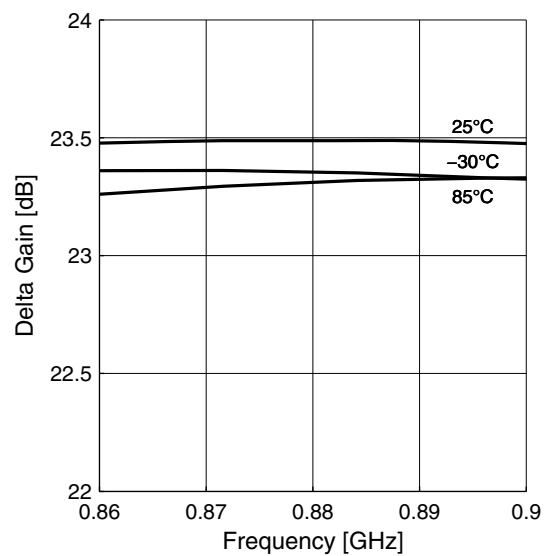
Power Gain wideband  $|S_{21}| = f(f)$



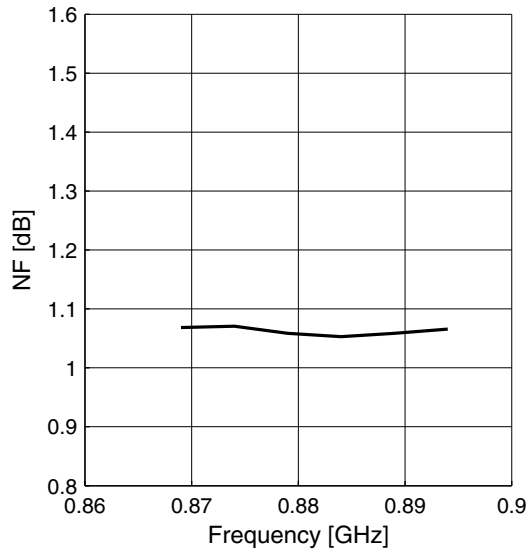
Matching  $|S_{11}| = f(f)$ ,  $|S_{22}| = f(f)$



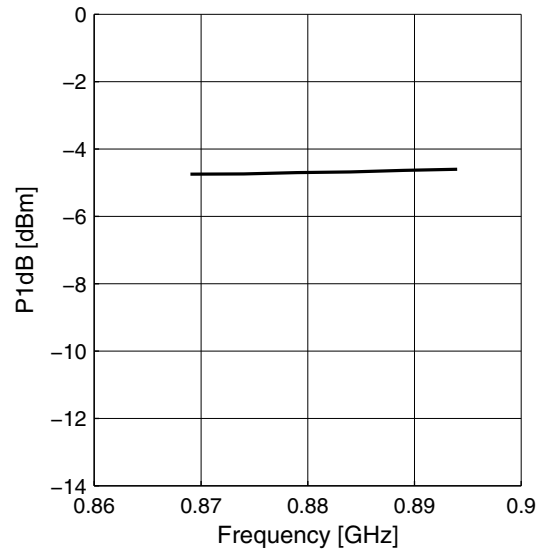
Gainstep HG-LG  $\Delta S_{21} = f(f)$



**Noise Figure  $NF = f(f)$**



**Input Compression  $P1dB = f(f)$**

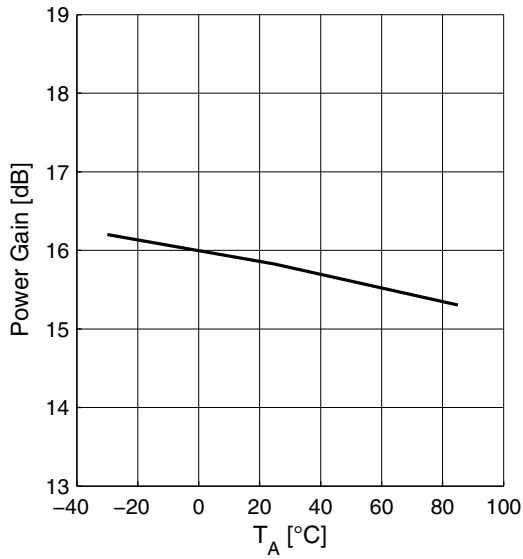




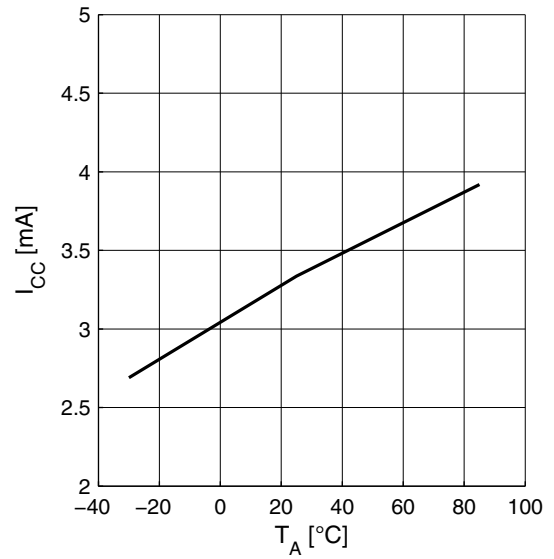
## 2.20 Measured Performance Band 5 Application High Gain Mode vs. Temperature

$T_A = 25\text{ }^\circ\text{C}$ ,  $V_{CC} = 2.8\text{ V}$ ,  $V_{GS} = 2.8\text{ V}$ ,  $V_{EN} = 2.8\text{ V}$ ,  $f = 800\text{ MHz}$ ,  $R_{REF} = n/c$

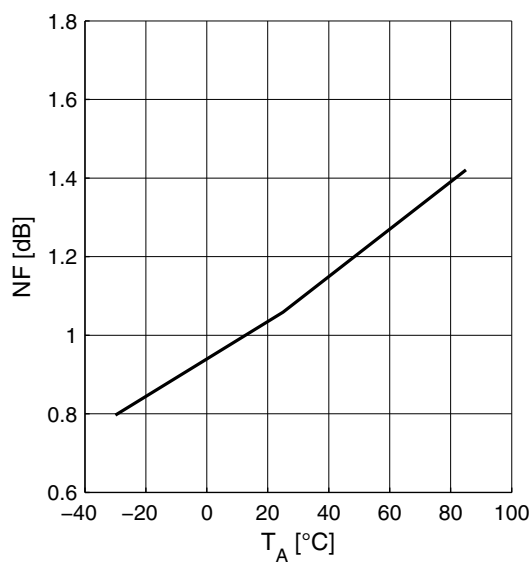
Power Gain  $|S_{21}| = f(T_A)$



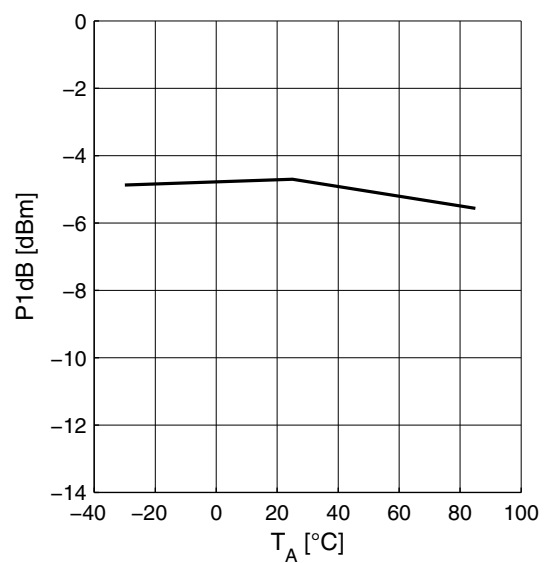
Supply Current  $I_{CC} = f(T_A)$



Noise Figure  $NF = f(T_A)$



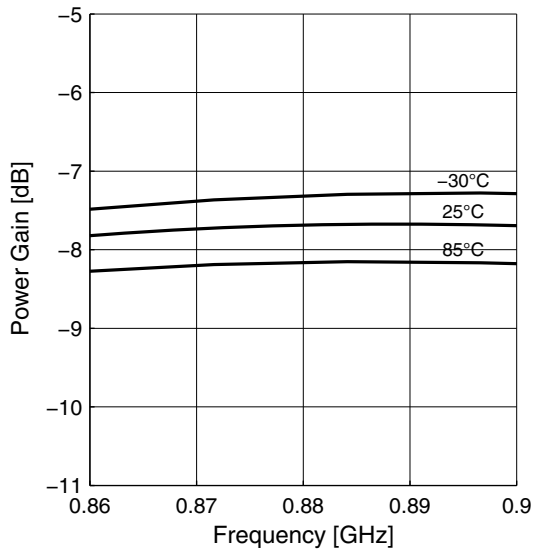
Input Compression  $P1dB = f(T_A)$



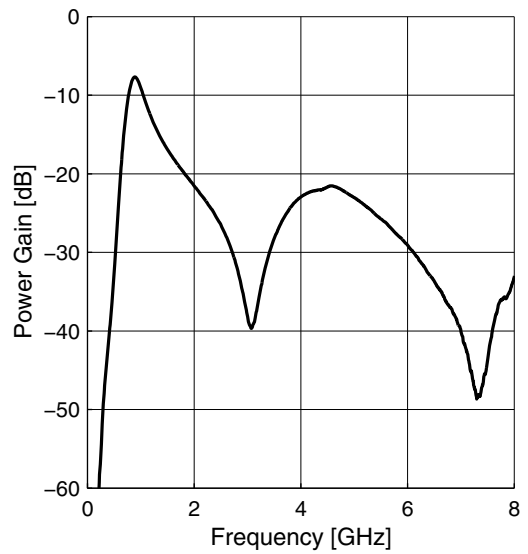
### 2.21 Measured Performance Band 5 Application Low Gain Mode vs. Frequency

$T_A = 25\text{ }^\circ\text{C}$ ,  $V_{CC} = 2.8\text{ V}$ ,  $V_{GS} = 0\text{ V}$ ,  $V_{EN} = 2.8\text{ V}$ ,  $R_{REF} = n/c$

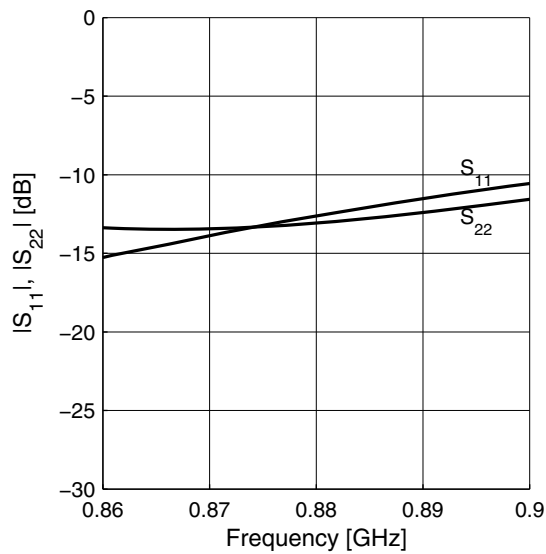
Power Gain  $|S_{21}| = f(f)$



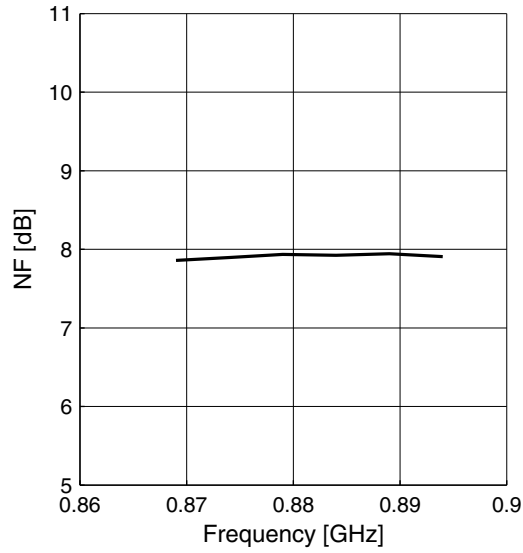
Power Gain wideband  $|S_{21}| = f(f)$



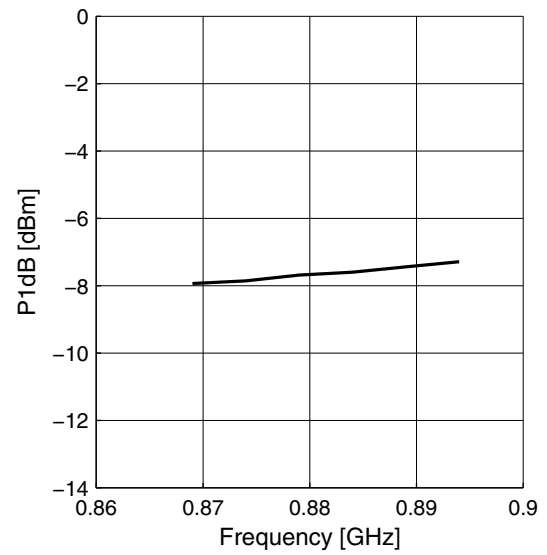
Matching  $|S_{11}| = f(f)$ ,  $|S_{22}| = f(f)$



**Noise Figure  $NF = f(f)$**



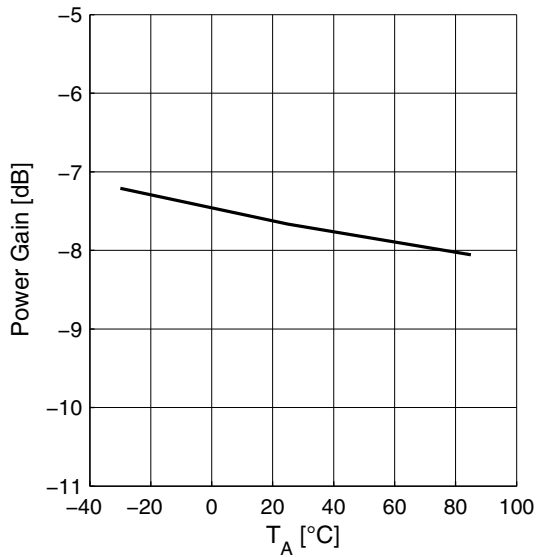
**Input Compression  $P1dB = f(f)$**



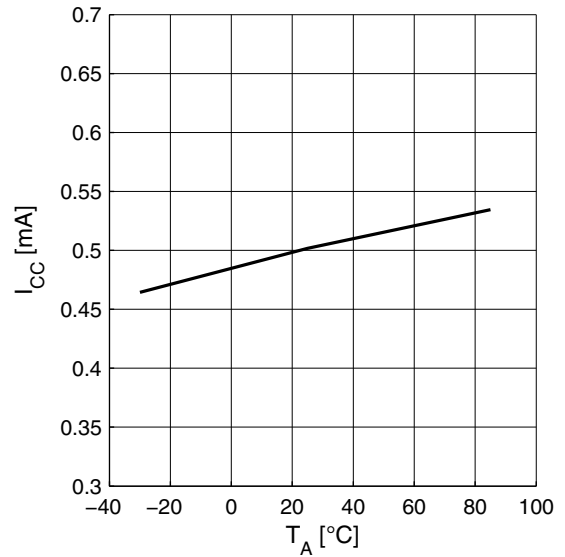
### 2.22 Measured Performance Band 5 Application Low Gain Mode vs. Temperature

$T_A = 25\text{ }^\circ\text{C}$ ,  $V_{CC} = 2.8\text{ V}$ ,  $V_{GS} = 0\text{ V}$ ,  $V_{EN} = 2.8\text{ V}$ ,  $f = 800\text{ MHz}$ ,  $R_{REF} = n/c$

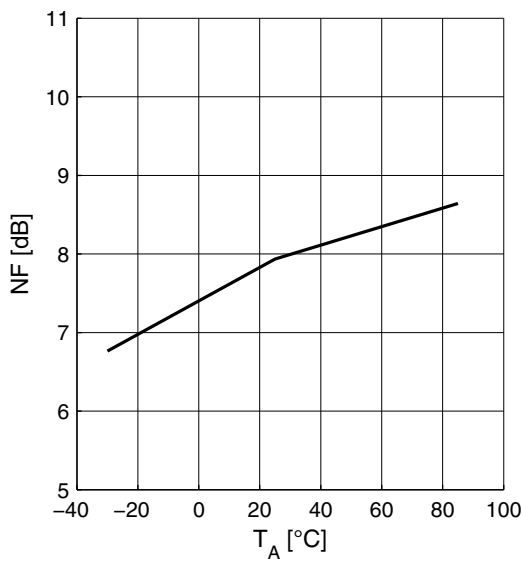
Power Gain  $|S_{21}| = f(T_A)$



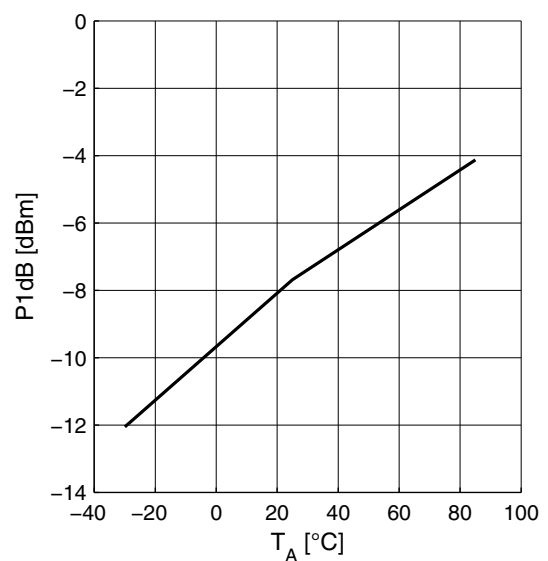
Supply Current  $I_{CC} = f(T_A)$



Noise Figure  $NF = f(T_A)$

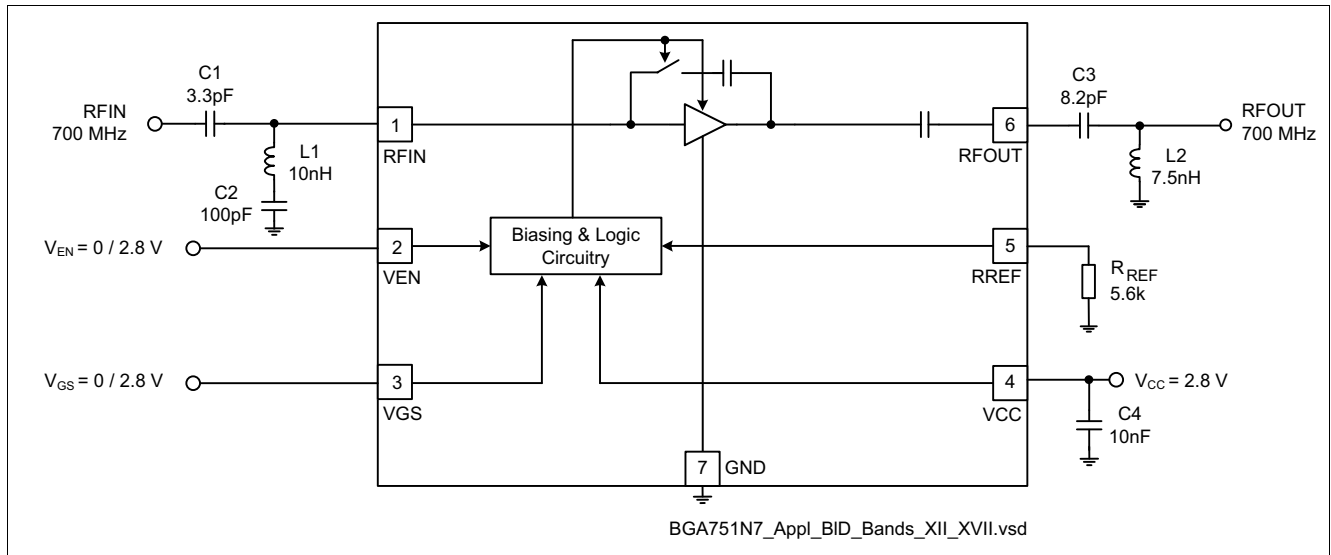


Input Compression  $P1dB = f(T_A)$



### 3 Application Circuit and Block Diagram

#### 3.1 700 MHz Band Application Circuit Schematic



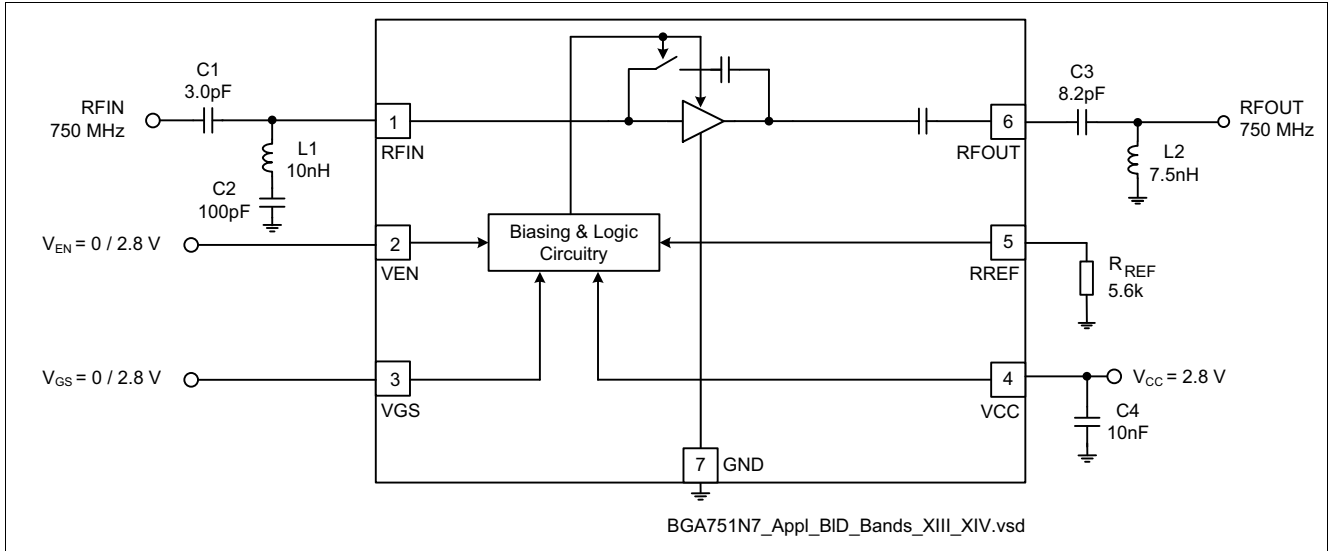
**Figure 2 Application Circuit with Chip Outline (top view)**

*Note: Package paddle (Pin 7) has to be RF grounded.*

**Table 13 Parts List**

Part Number	Part Type	Manufacturer	Size	Comment
L1 ... L2	Chip inductor	Various	0402	Wirewound, Q ≈ 50
C1 ... C4	Chip capacitor	Various	0402	
RREF	Chip resistor	Various	0402	

### 3.2 750 MHz Band Application Circuit Schematic



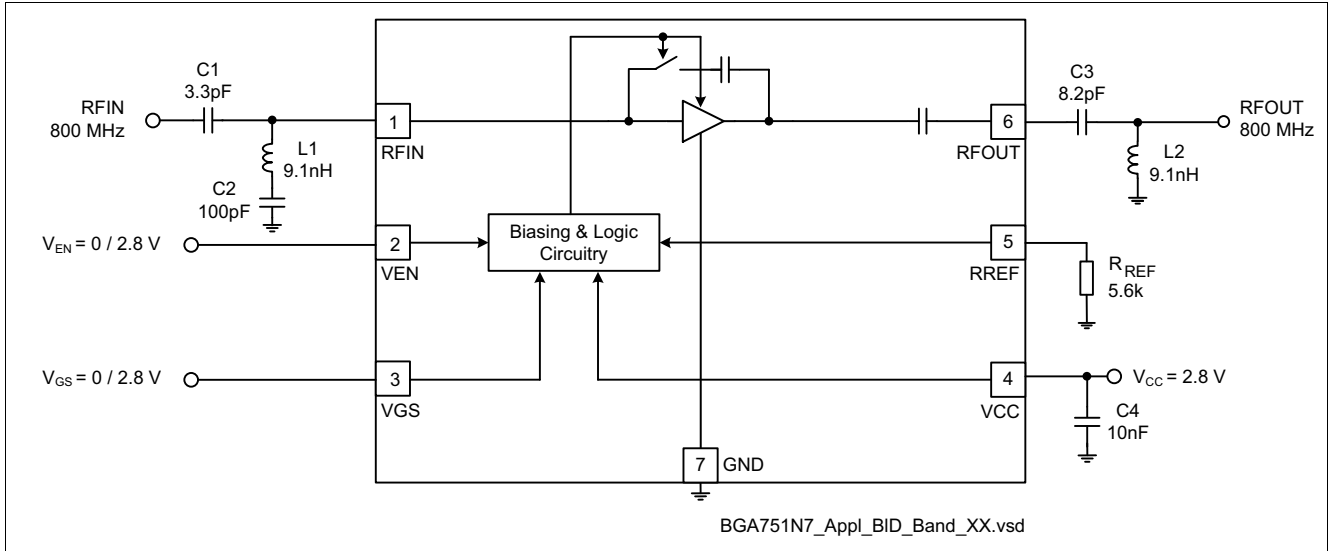
**Figure 3 Application Circuit with Chip Outline (top view)**

*Note: Package paddle (Pin 7) has to be RF grounded.*

**Table 14 Parts List**

Part Number	Part Type	Manufacturer	Size	Comment
L1 ... L2	Chip inductor	Various	0402	Wirewound, $Q \approx 50$
C1 ... C4	Chip capacitor	Various	0402	
RREF	Chip resistor	Various	0402	

### 3.3 800 MHz Band Application Circuit Schematic



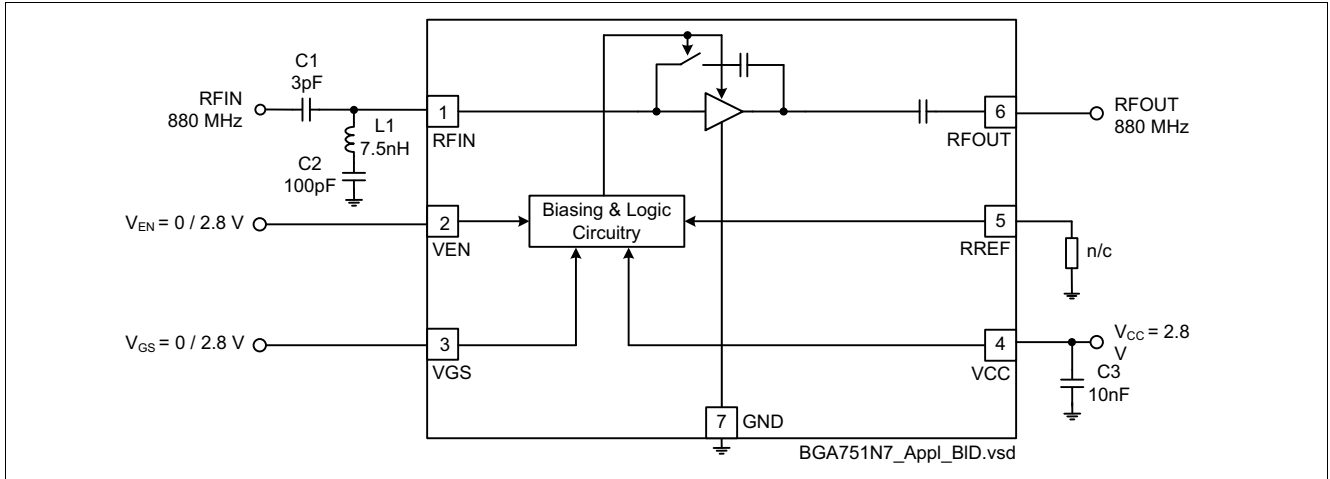
**Figure 4 Application Circuit with Chip Outline (top view)**

Note: Package paddle (Pin 7) has to be RF grounded.

**Table 15 Parts List**

Part Number	Part Type	Manufacturer	Size	Comment
L1 ... L2	Chip inductor	Various	0402	Wirewound, Q ≈ 50
C1 ... C4	Chip capacitor	Various	0402	
RREF	Chip resistor	Various	0402	

### 3.4 880 MHz Band Application Circuit Schematic



**Figure 5 Application Circuit with Chip Outline (top view)**

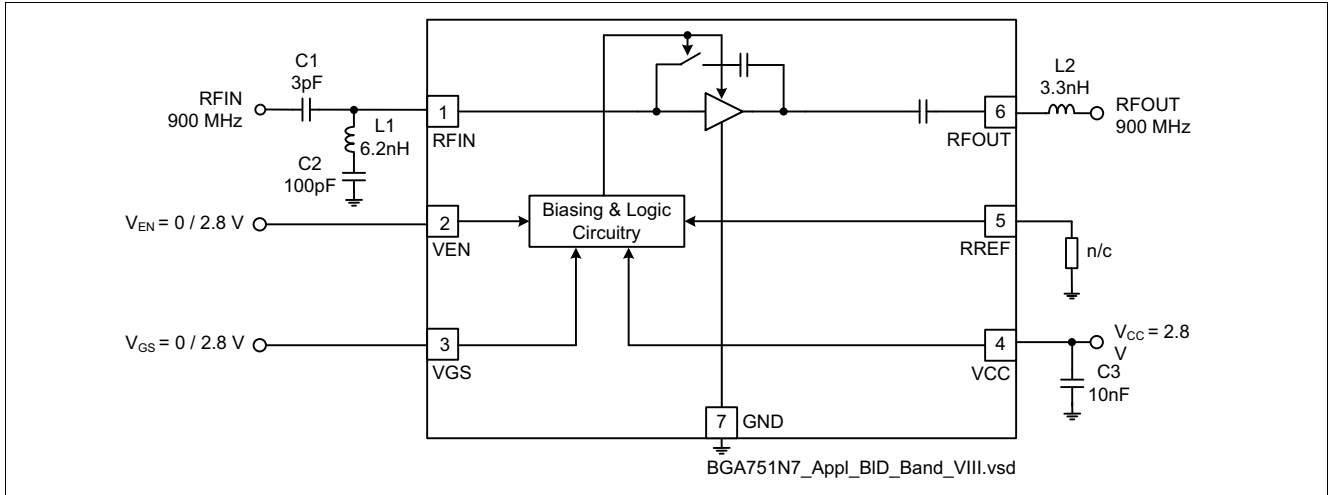
*Note: Package paddle (Pin 7) has to be RF grounded.*

**Table 16 Parts List**

Part Number	Part Type	Manufacturer	Size	Comment
L1	Chip inductor	Various	0402	Wirewound, Q ≈ 50
C1 ... C3	Chip capacitor	Various	0402	



### 3.5 900 MHz Band Application Circuit Schematic



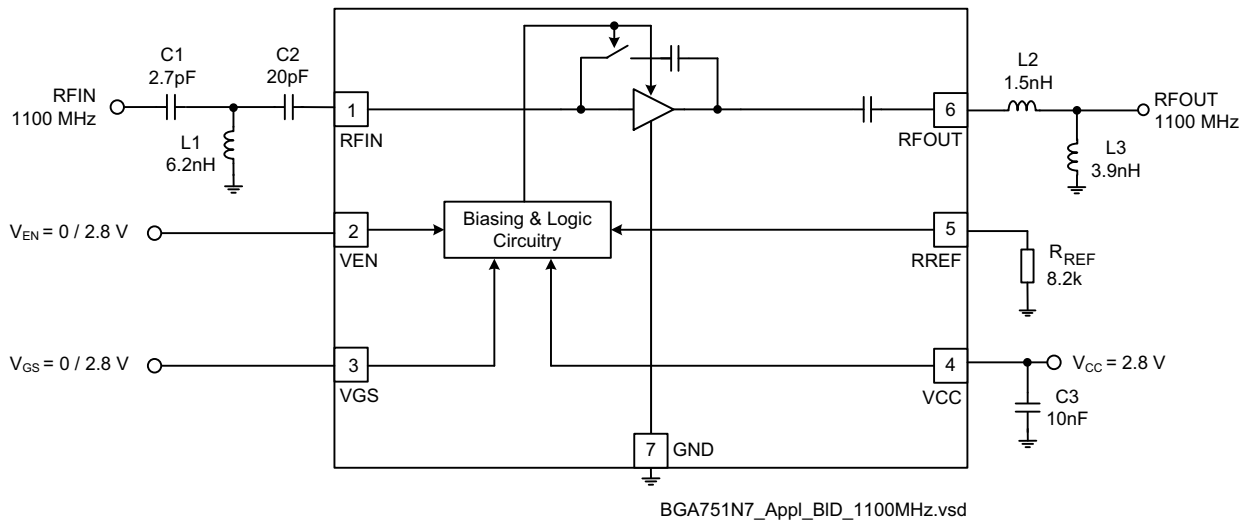
**Figure 6 Application Circuit with Chip Outline (top view)**

*Note: Package paddle (Pin 7) has to be RF grounded.*

**Table 17 Parts List**

Part Number	Part Type	Manufacturer	Size	Comment
L1, L2	Chip inductor	Various	0402	Wirewound, Q ≈ 50
C1 ... C3	Chip capacitor	Various	0402	

### 3.6 1100 MHz Band Application Circuit Schematic



**Figure 7 Application Circuit with Chip Outline (top view)**

Note: Package paddle (Pin 7) has to be RF grounded.

**Table 18 Parts List**

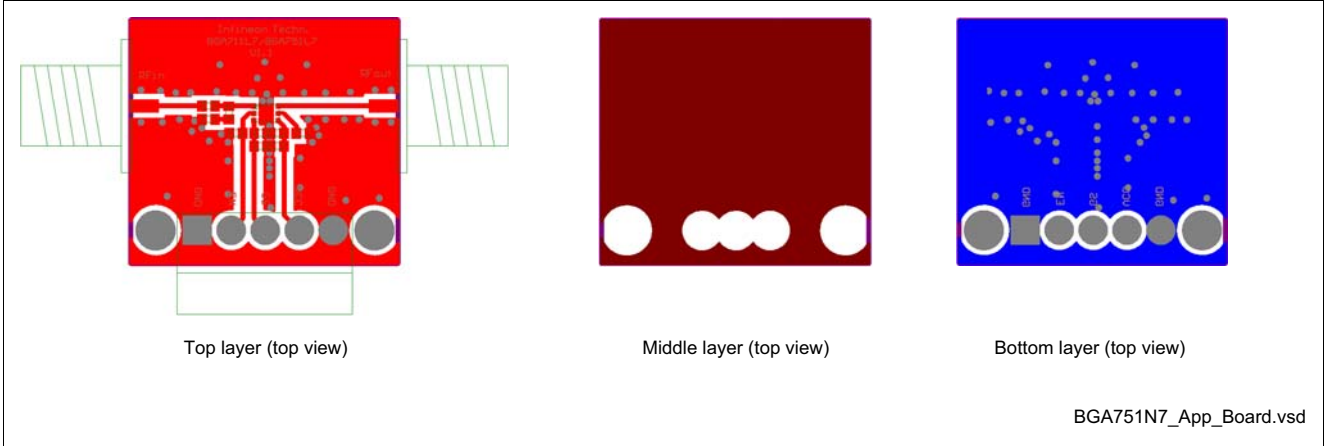
Part Number	Part Type	Manufacturer	Size	Comment
L1 ... L3	Chip inductor	Various	0402	Wirewound, Q ≈ 50
C1 ... C3	Chip capacitor	Various	0402	
RREF	Chip resistor	Various	0402	

### 3.7 Pin Definition

**Table 19 Pin Definition and Function**

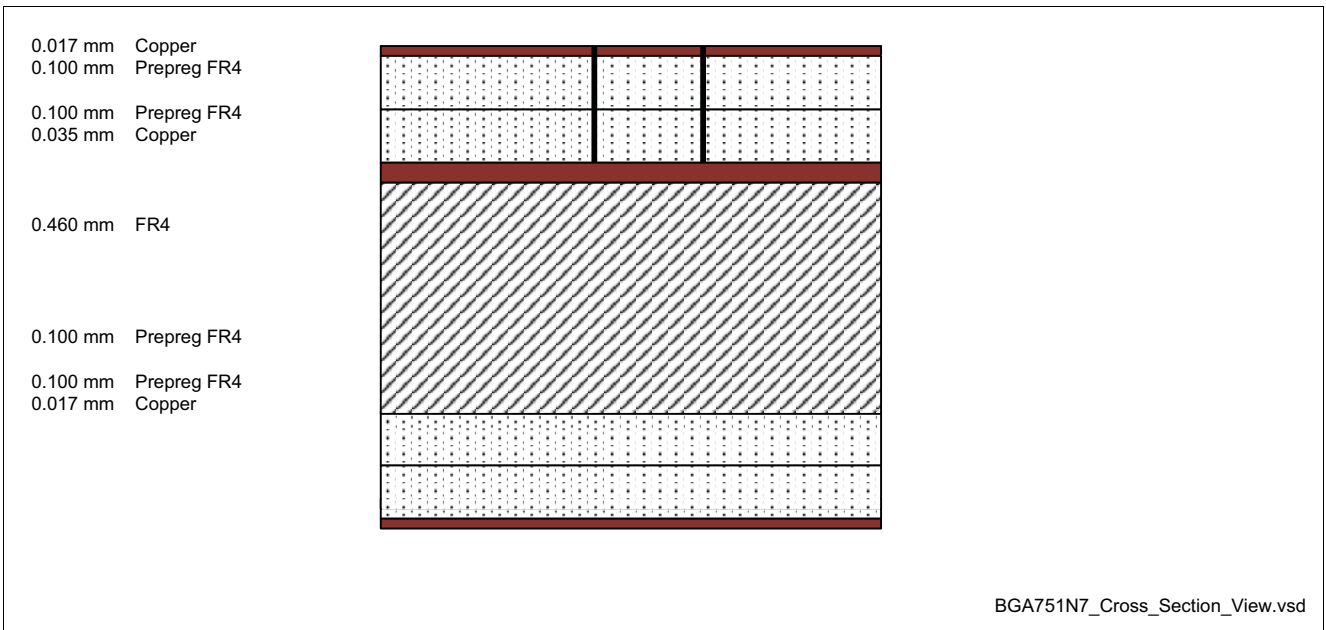
Pin Number	Symbol	Function
1	RFIN	LNA input
2	VEN	Band select control
3	VGS	Gain step control
4	VCC	Supply voltage
5	RREF	Bias current reference resistor (high gain mode)
6	RFOUT	LNA output
7	GND	Package paddle; ground connection for LNA and control circuitry

### 3.8 Application Board

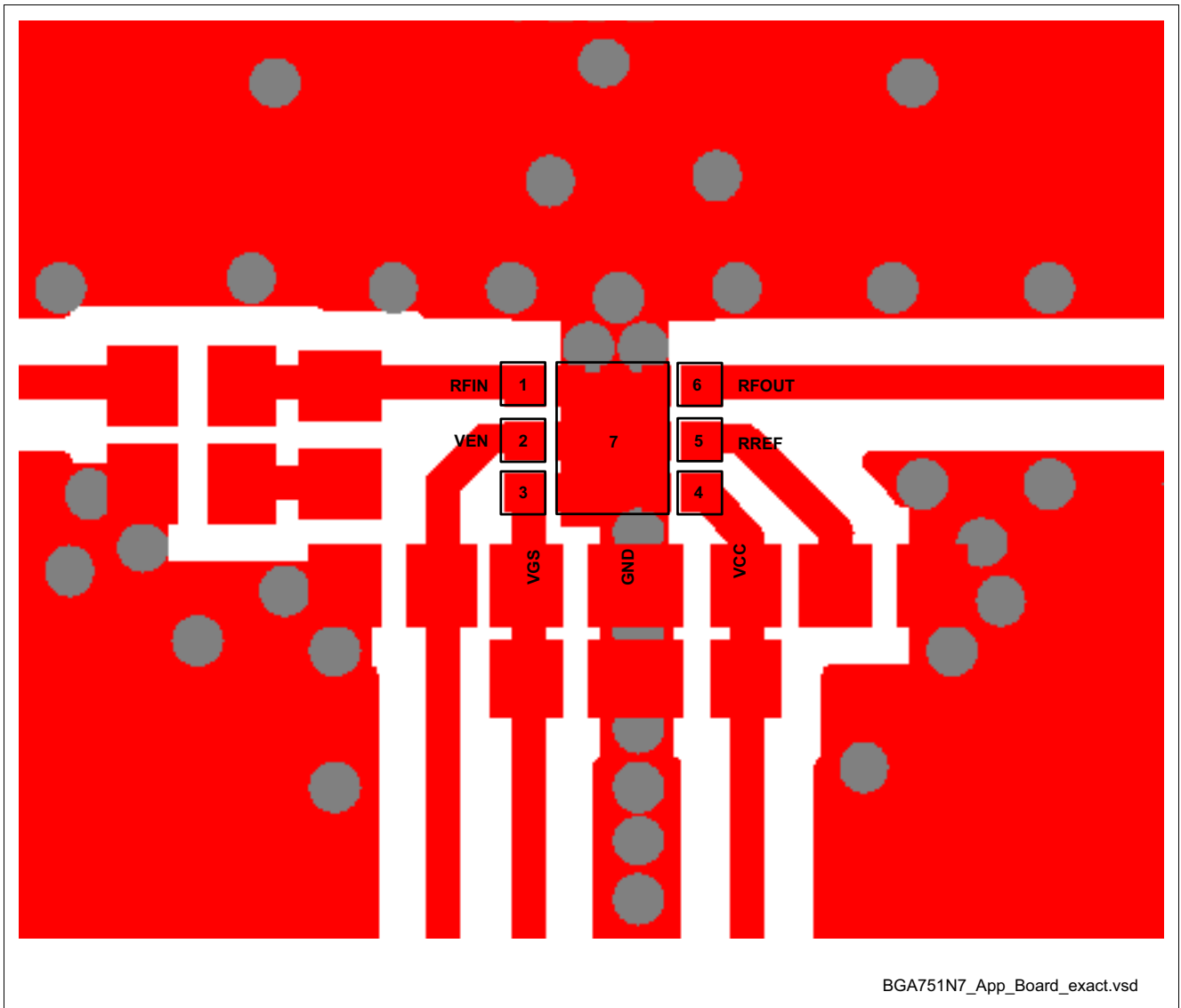


**Figure 8 Application Board Layout on 3-layer FR4**

Note: Top layer thickness: 0.2 mm, bottom layer thickness: 0.8 mm, 17 mm Cu metallization, gold plated. Board size: 21 x 19mm.



**Figure 9 Cross-Section view of Application Board**



**Figure 10** Detail of Application Board Layout

*Note: In order to achieve the same performance as given in this datasheet please follow the suggested PCB-layout as closely as possible. The position of the GND vias is critical for RF performance.*

## 4 Physical Characteristics

### 4.1 Package Footprint

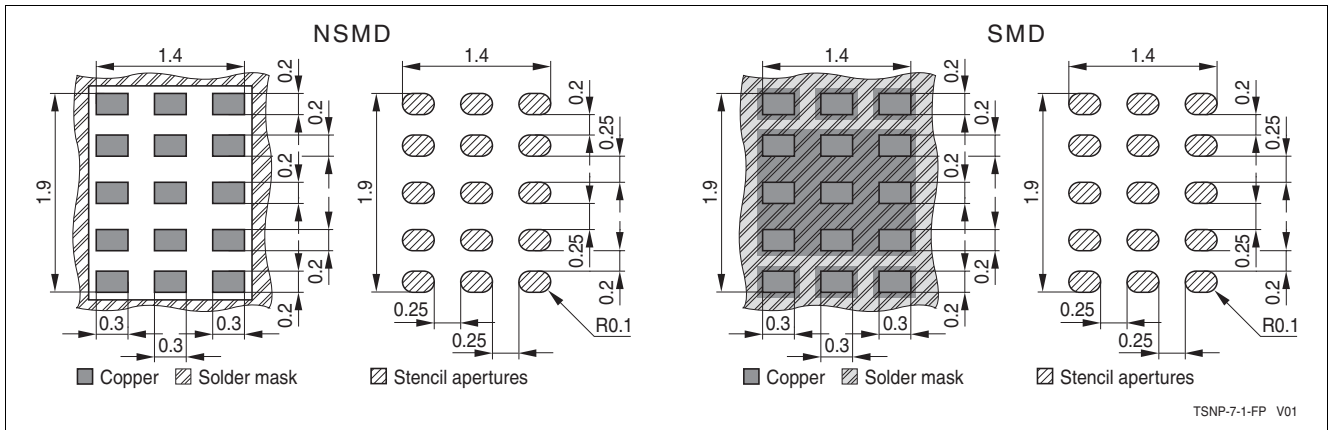


Figure 11 Footprint Recommendation 1 for the TSNP-7-1 Package

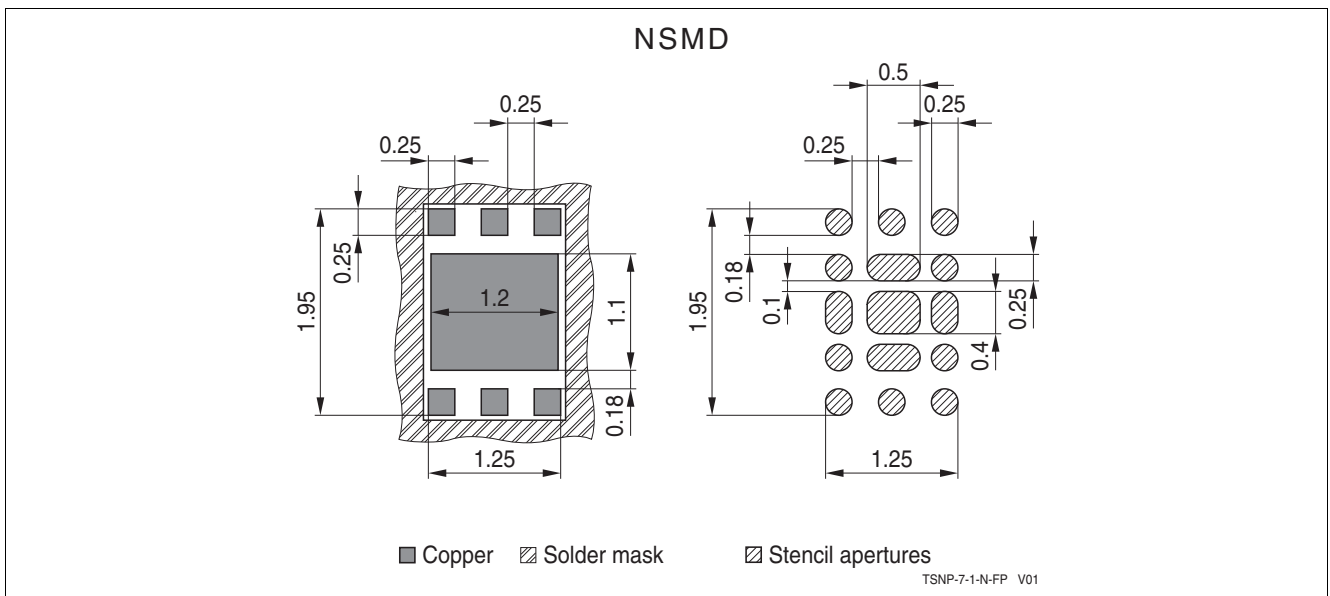


Figure 12 Footprint Recommendation 2 for the TSNP-7-1 Package

## 4.2 Package Dimensions

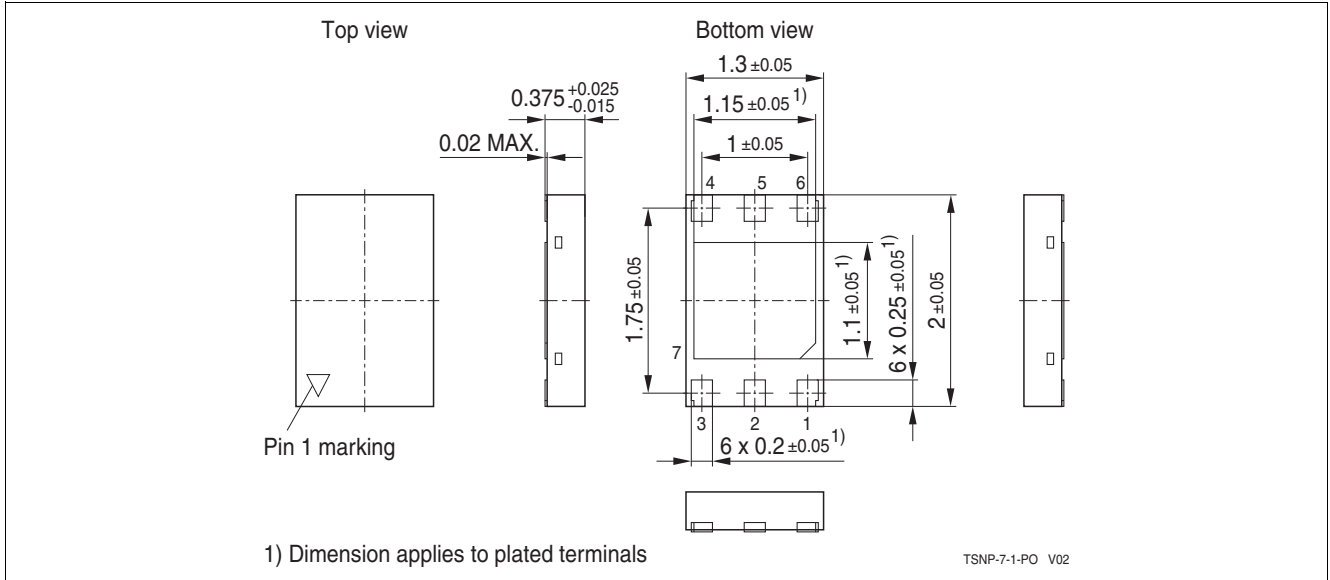


Figure 13 Package Outline (top, side and bottom view)

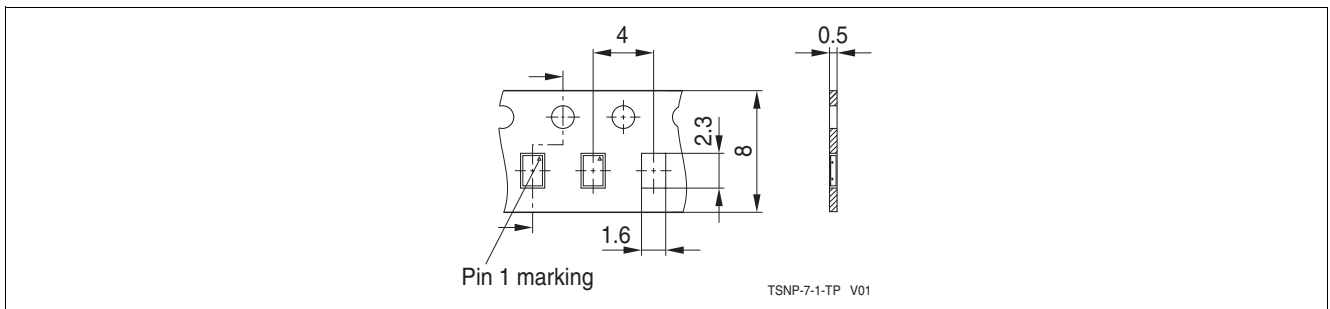


Figure 14 Tape & Reel Dimensions

## 4.3 Product Marking Pattern

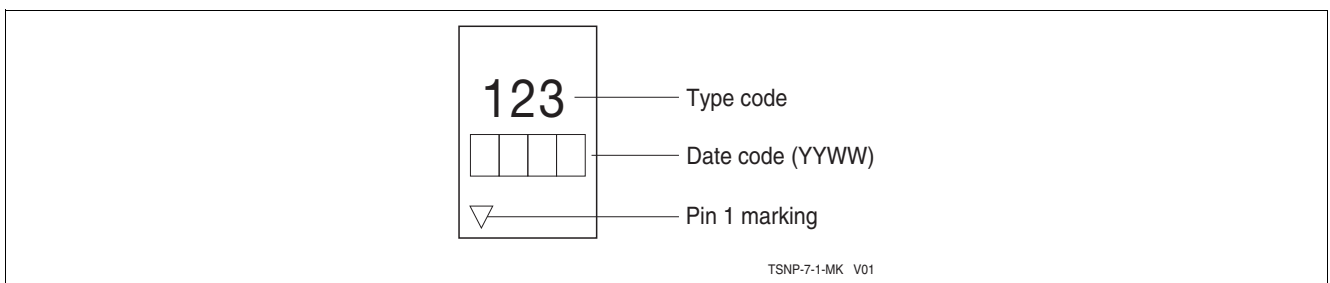


Figure 15 Marking Pattern (top view)

[www.infineon.com](http://www.infineon.com)

Published by Infineon Technologies AG