

HEXFET® Power MOSFET

	Q1	Q2	
V_{DS}	30	30	V
R_{DS(on)} max (@ V _{GS} = 10V)	8.6	3.0	mΩ
Q_g (typical)	8.3	34	nC
I_D (@ T _A = 25°C)	13	28	A

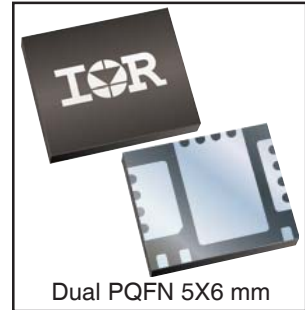
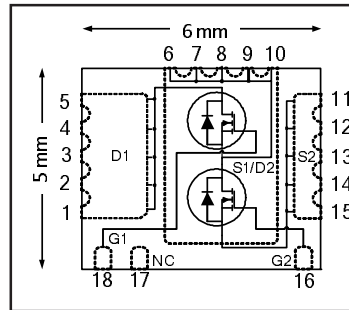

Applications

- Control and synchronous MOSFET for buck converters

Features and Benefits

Features

Control and synchronous FET in one package
Low charge control MOSFET (8.3 nC typical)
Low R _{DS(on)} synchronous MOSFET (< 3.0 mΩ)
100% R _g tested
Low Profile (≤ 0.9 mm)
Compatible with Existing Surface Mount Techniques
RoHS Compliant Containing no Lead, no Bromide and no Halogen
MSL2, Consumer Qualification

results in
⇒

Benefits

Increased power density (50% vs two PQFN 5x6)
Lower switching losses
Lower conduction losses
Increased reliability
Increased power density
Easier manufacturing
Environmentally Friendlier
Increased reliability

Orderable part number	Package Type	Standard Pack		Note
		Form	Quantity	
IRFH7911TRPbF	PQFN 5mm x 6mm	Tape and Reel	4000	
IRFH7911TR2PbF	PQFN 5mm x 6mm	Tape and Reel	400	EOL notice # 259

Absolute Maximum Ratings

	Parameter	Q1 Max.	Q2 Max.	Units
V _{DS}	Drain-to-Source Voltage	30		V
V _{GS}	Gate-to-Source Voltage	± 20		
I _D @ T _A = 25°C	Continuous Drain Current, V _{GS} @ 10V	13	28	A
I _D @ T _A = 70°C	Continuous Drain Current, V _{GS} @ 10V	10	23	
I _{DM}	Pulsed Drain Current ①	100	230	
P _D @ T _A = 25°C	Power Dissipation	2.4	3.4	W
P _D @ T _A = 70°C	Power Dissipation	1.5	2.2	
	Linear Derating Factor ⑤	0.019	0.027	W/°C
T _J T _{STG}	Operating Junction and Storage Temperature Range	-55 to + 150		°C

Thermal Resistance

	Parameter	Q1 Max.	Q2 Max.	Units
R _{θJC}	Junction-to-Case ④	7.7	2.5	°C/W
R _{θJA}	Junction-to-Ambient ⑤	53	37	

Static @ T_J = 25°C (unless otherwise specified)

	Parameter		Min.	Typ.	Max.	Units	Conditions	
V_{DSS}	Drain-to-Source Breakdown Voltage	Q1&Q2	30	—	—	V	$V_{GS} = 0V, I_D = 250\mu A$	
$\Delta BV_{DSS}/\Delta T_J$	Breakdown Voltage Temp. Coefficient	Q1	—	0.021	—	V/°C	Reference to 25°C, $I_D = 1mA$	
		Q2	—	0.022	—			
$R_{DS(on)}$	Static Drain-to-Source On-Resistance	Q1	—	7.2	8.6	mΩ	$V_{GS} = 10V, I_D = 12A$ ③	
			—	11.1	14.5		$V_{GS} = 4.5V, I_D = 10A$ ③	
		Q2	—	2.4	3.0		$V_{GS} = 10V, I_D = 26A$ ③	
			—	3.4	4.0		$V_{GS} = 4.5V, I_D = 21A$ ③	
$V_{GS(th)}$	Gate Threshold Voltage	Q1&Q2	1.35	—	2.35	V	Q1: $V_{DS} = V_{GS}, I_D = 25\mu A$	
$\Delta V_{GS(th)}/\Delta T_J$	Gate Threshold Voltage Coefficient	Q1	—	-6.8	—	mV/°C	Q2: $V_{DS} = V_{GS}, I_D = 100\mu A$	
		Q2	—	-6.4	—			
I_{DSS}	Drain-to-Source Leakage Current	Q1&Q2	—	—	1.0	μA	$V_{DS} = 24V, V_{GS} = 0V$	
		Q1&Q2	—	—	150		$V_{DS} = 24V, V_{GS} = 0V, T_J = 125^\circ C$	
I_{GSS}	Gate-to-Source Forward Leakage	Q1&Q2	—	—	100	nA	$V_{GS} = 20V$	
	Gate-to-Source Reverse Leakage	Q1&Q2	—	—	-100		$V_{GS} = -20V$	
gfs	Forward Transconductance	Q1	17	—	—	S	$V_{DS} = 15V, I_D = 10A$	
		Q2	106	—	—		$V_{DS} = 15V, I_D = 21A$	
Q_g	Total Gate Charge	Q1	—	8.3	12	nC	Q1 $V_{DS} = 15V$ $V_{GS} = 4.5V, I_D = 10A$	
		Q2	—	34	51			
Q_{gs1}	Pre-V _{th} Gate-to-Source Charge	Q1	—	2.0	—			
		Q2	—	7.9	—			
Q_{gs2}	Post-V _{th} Gate-to-Source Charge	Q1	—	1.0	—			
		Q2	—	3.6	—			
Q_{gd}	Gate-to-Drain Charge	Q1	—	3.2	—		Q2 $V_{DS} = 15V$ $V_{GS} = 4.5V, I_D = 21A$	
		Q2	—	11	—			
Q_{godr}	Gate Charge Overdrive	Q1	—	2.1	—			
		Q2	—	12	—			
Q_{sw}	Switch Charge ($Q_{gs2} + Q_{gd}$)	Q1	—	4.2	—			
		Q2	—	15	—			
Q_{oss}	Output Charge	Q1	—	5.0	—		nC	$V_{DS} = 16V, V_{GS} = 0V$
		Q2	—	19	—			
R_G	Gate Resistance	Q1	—	1.8	—	Ω		
		Q2	—	0.7	—			
$t_{d(on)}$	Turn-On Delay Time	Q1	—	12	—	ns	Q1 $V_{DD} = 15V, V_{GS} = 4.5V$ $I_D = 10A$ $R_G = 1.8\Omega$	
		Q2	—	22	—			
t_r	Rise Time	Q1	—	15	—			
		Q2	—	35	—			
$t_{d(off)}$	Turn-Off Delay Time	Q1	—	12	—		Q2 $V_{DD} = 15V, V_{GS} = 4.5V$ $I_D = 21A$ $R_G = 1.8\Omega$	
		Q2	—	28	—			
t_f	Fall Time	Q1	—	5.9	—			
		Q2	—	14	—			
C_{iss}	Input Capacitance	Q1	—	1060	—		pF	$V_{GS} = 0V$ $V_{DS} = 15V$ $f = 1.0MHz$
		Q2	—	4450	—			
C_{oss}	Output Capacitance	Q1	—	230	—			
		Q2	—	850	—			
C_{rss}	Reverse Transfer Capacitance	Q1	—	110	—			
		Q2	—	440	—			

Avalanche Characteristics

	Parameter	Typ.	Q1 Max.	Q2 Max.	Units
E_{AS}	Single Pulse Avalanche Energy ②	—	12	32	mJ
I_{AR}	Avalanche Current ①	—	10	21	A

Diode Characteristics

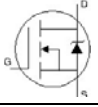
	Parameter		Min.	Typ.	Max.	Units	Conditions	
I_S	Continuous Source Current (Body Diode)	Q1	—	—	3.0	A	MOSFET symbol showing the integral reverse p-n junction diode. 	
		Q2	—	—	3.0			
I_{SM}	Pulsed Source Current (Body Diode) ①	Q1	—	—	100	A		
		Q2	—	—	230			
V_{SD}	Diode Forward Voltage	Q1	—	—	1.0	V		$T_J = 25^\circ C, I_S = 10A, V_{GS} = 0V$ ③
		Q2	—	—	1.0			$T_J = 25^\circ C, I_S = 21A, V_{GS} = 0V$ ③
t_{rr}	Reverse Recovery Time	Q1	—	13	20	ns	Q1 $T_J = 25^\circ C, I_F = 10A, V_{DD} = 15V, di/dt = 300A/\mu s$ ③	
		Q2	—	20	29			
Q_{rr}	Reverse Recovery Charge	Q1	—	13	20	nC	Q2 $T_J = 25^\circ C, I_F = 21A, V_{DD} = 15V, di/dt = 280A/\mu s$ ③	
		Q2	—	24	36			

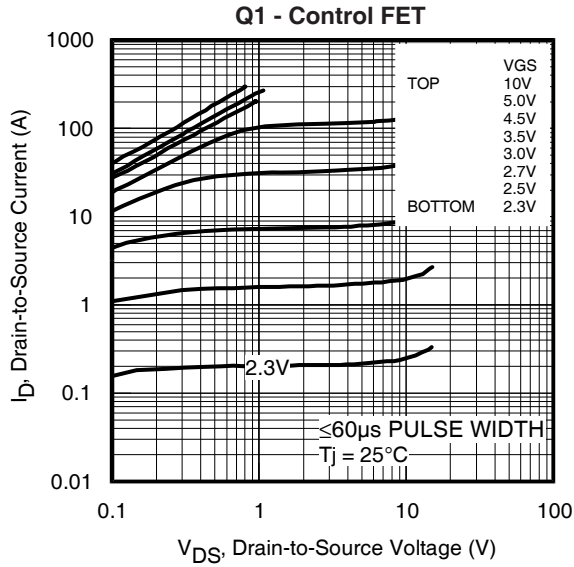
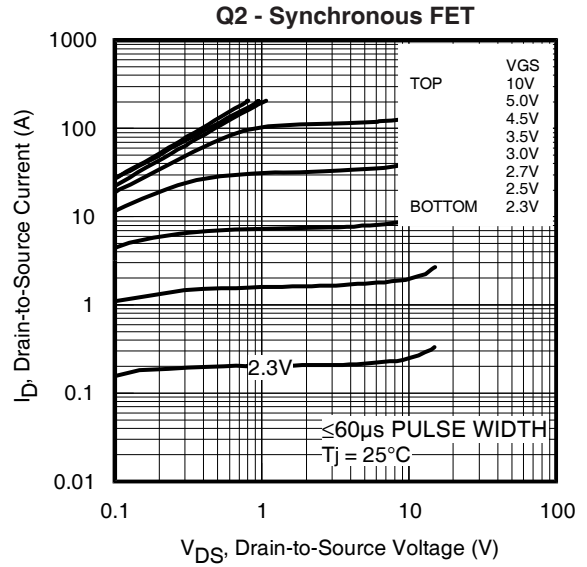
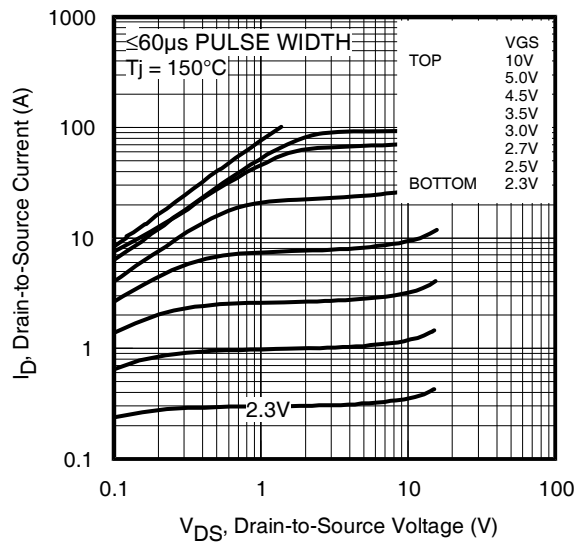
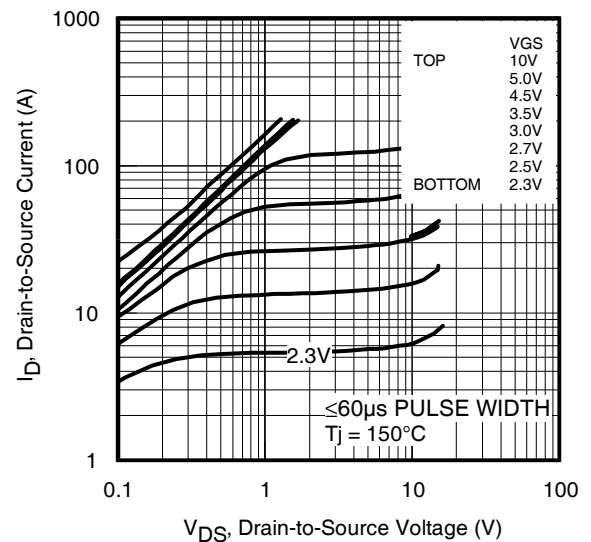
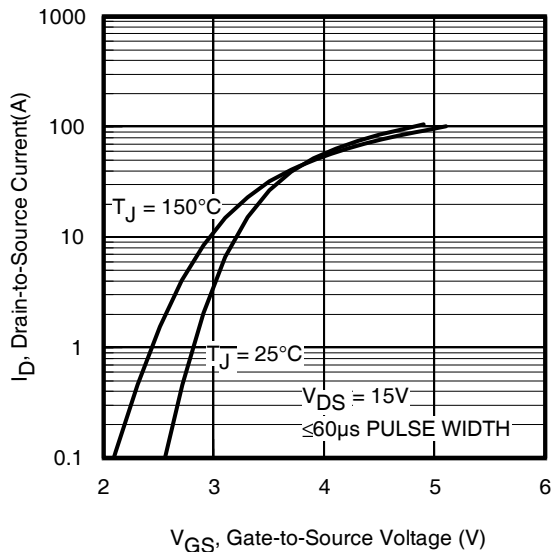
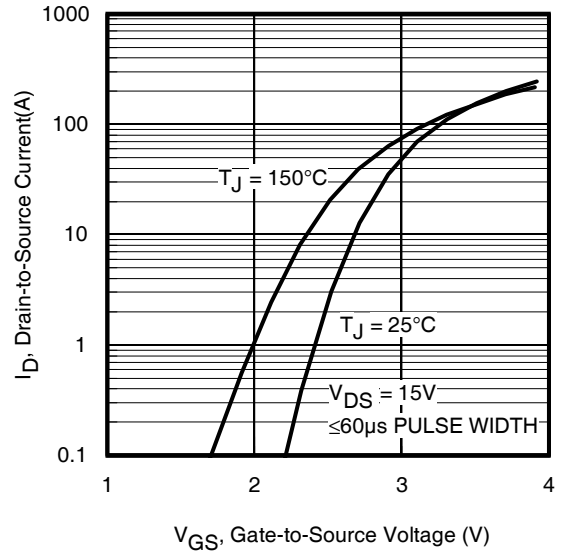
Typical Characteristics

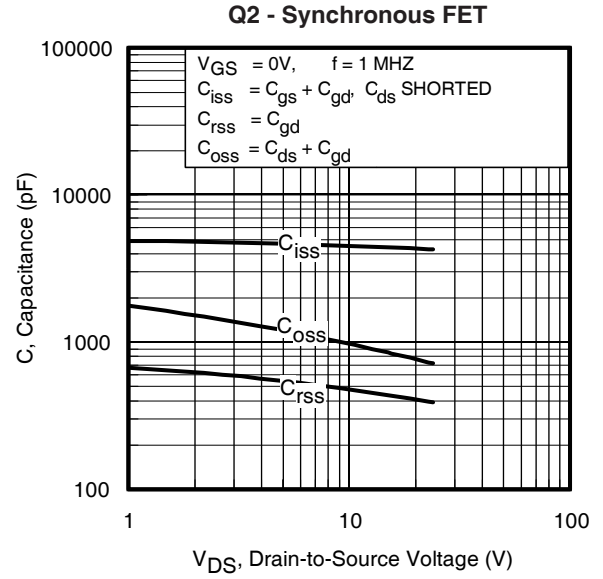
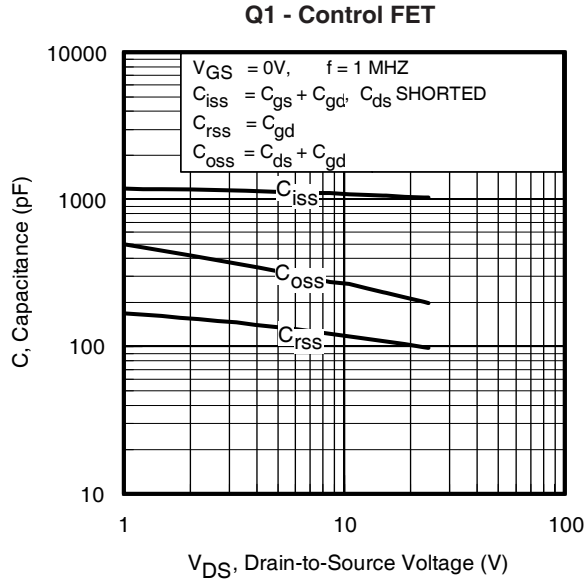
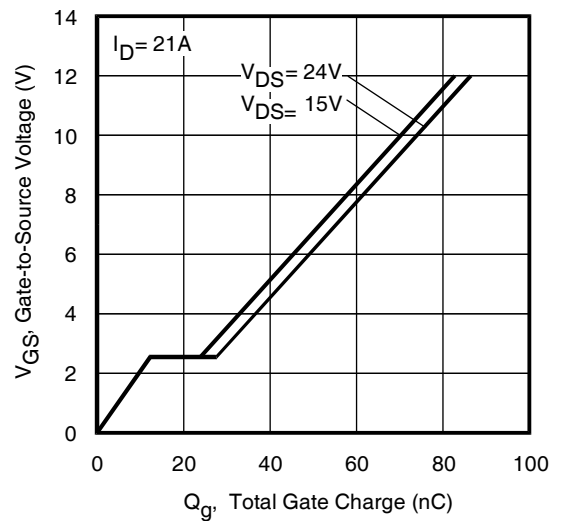
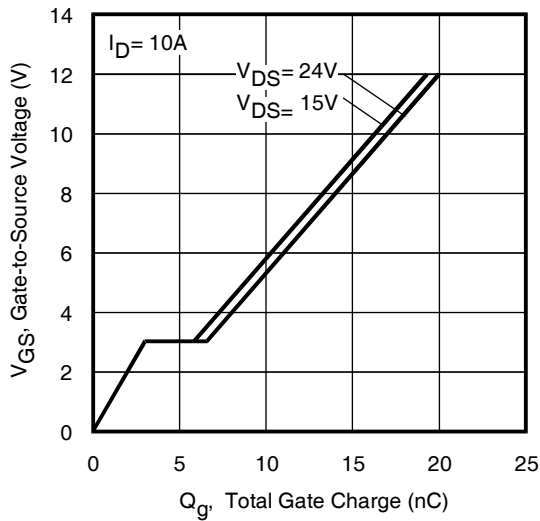
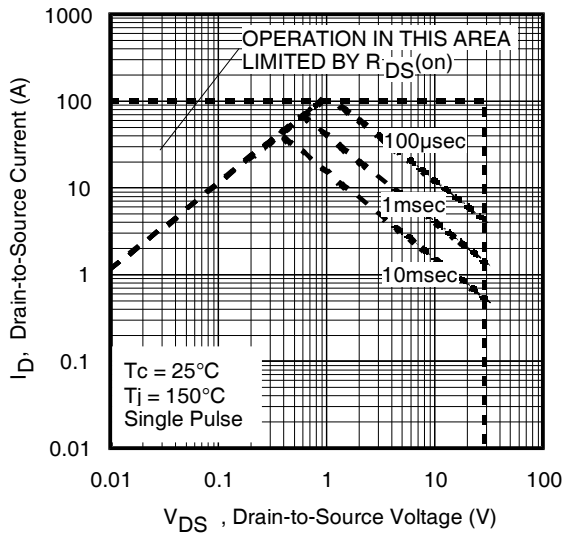
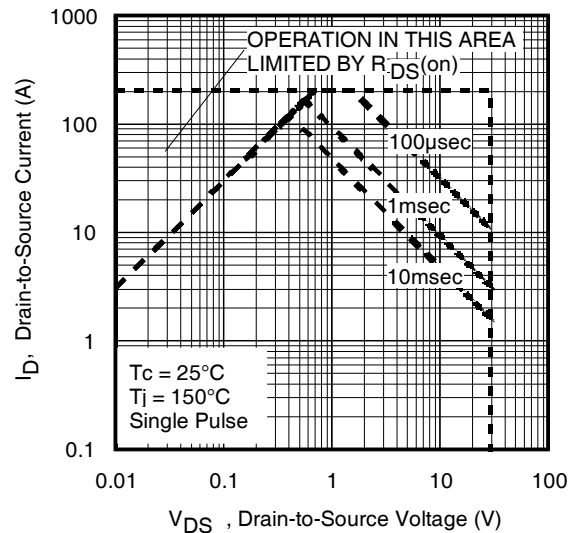
Fig 1. Typical Output Characteristics

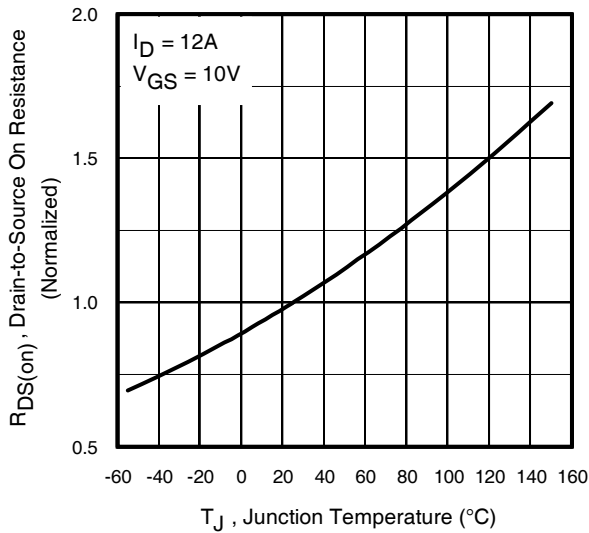
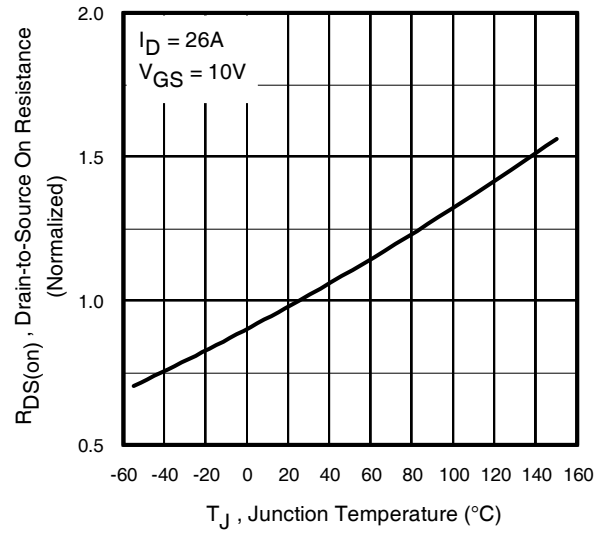
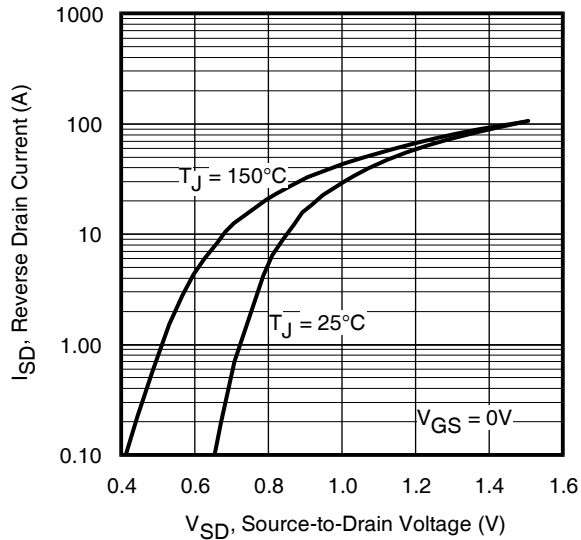
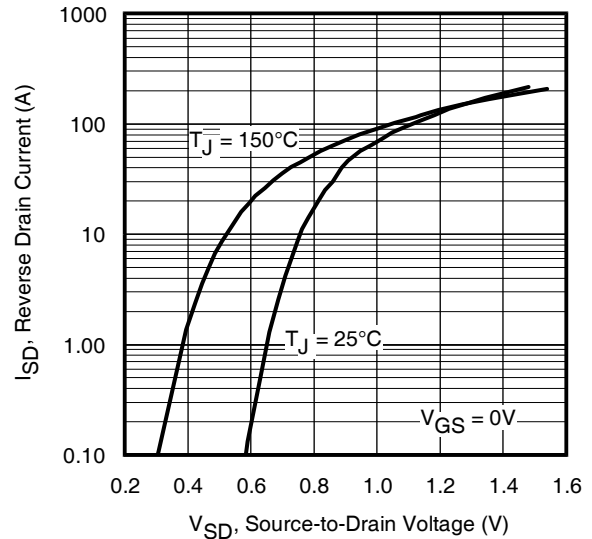
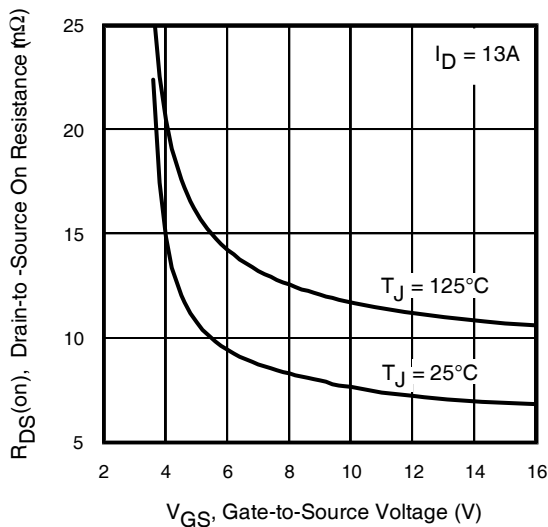
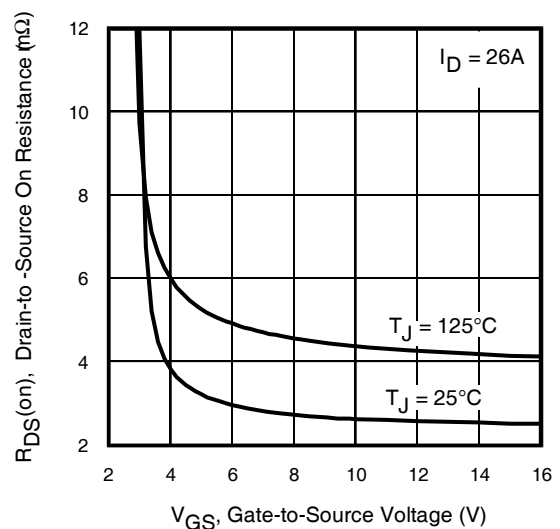
Fig 2. Typical Output Characteristics

Fig 3. Typical Output Characteristics

Fig 4. Typical Output Characteristics

Fig 5. Typical Transfer Characteristics

Fig 6. Typical Transfer Characteristics

Typical Characteristics

Fig 7. Typical Capacitance vs. Drain-to-Source Voltage **Fig 8. Typical Capacitance vs. Drain-to-Source Voltage**

Fig 9. Typical Gate Charge vs. Gate-to-Source Voltage
Fig 10. Typical Gate Charge vs. Gate-to-Source Voltage

Fig 11. Maximum Safe Operating Area

Fig 12. Maximum Safe Operating Area

Typical Characteristics
Q1 - Control FET

Fig 13. Normalized On-Resistance vs. Temperature
Q2 - Synchronous FET

Fig 14. Normalized On-Resistance vs. Temperature

Fig 15. Typical Source-Drain Diode Forward Voltage

Fig 16. Typical Source-Drain Diode Forward Voltage

Fig 17. Typical On-Resistance vs. Gate Voltage

Fig 18. Typical On-Resistance vs. Gate Voltage

Typical Characteristics

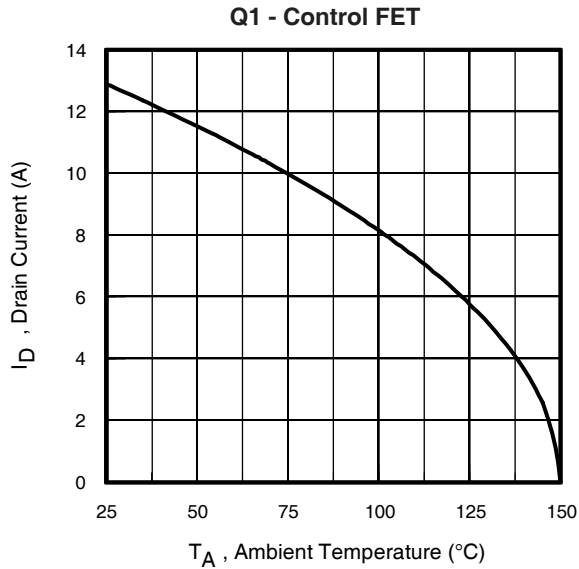

Fig 19. Maximum Drain Current vs. Ambient Temp.

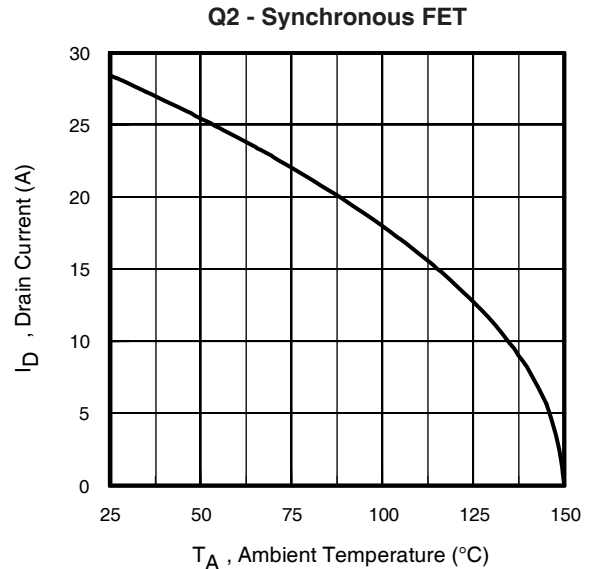

Fig 20. Maximum Drain Current vs. Ambient Temp.

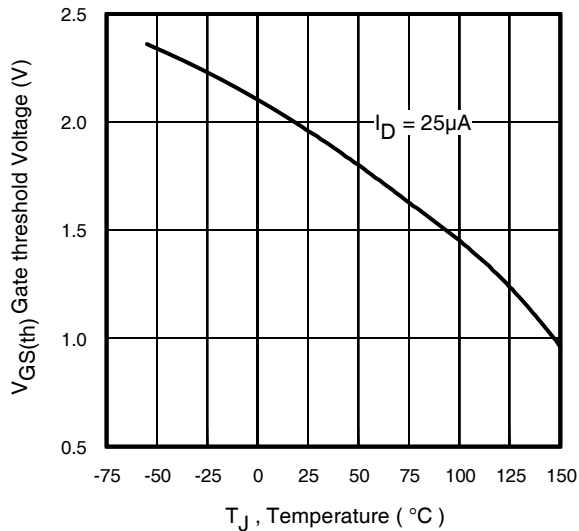

Fig 21. Threshold Voltage vs. Temperature

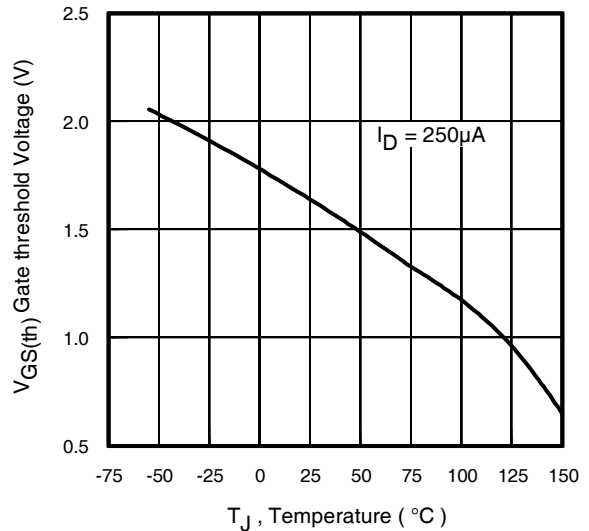

Fig 22. Threshold Voltage vs. Temperature

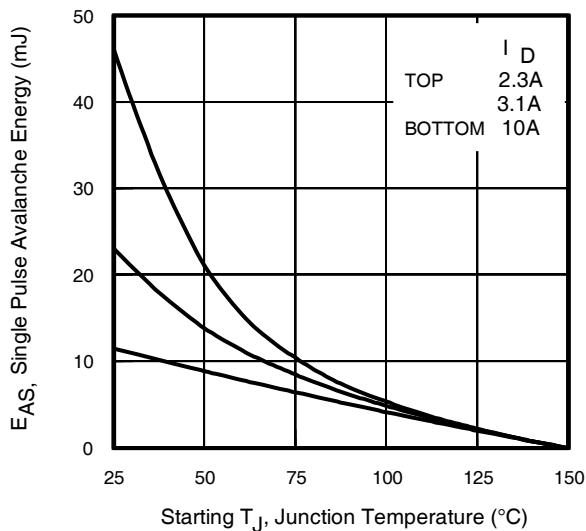

Fig 23. Maximum Avalanche Energy vs. Drain Current

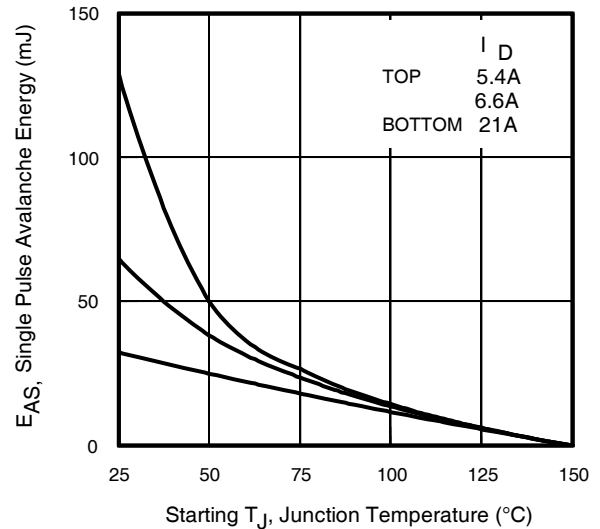

Fig 24. Maximum Avalanche Energy vs. Drain Current

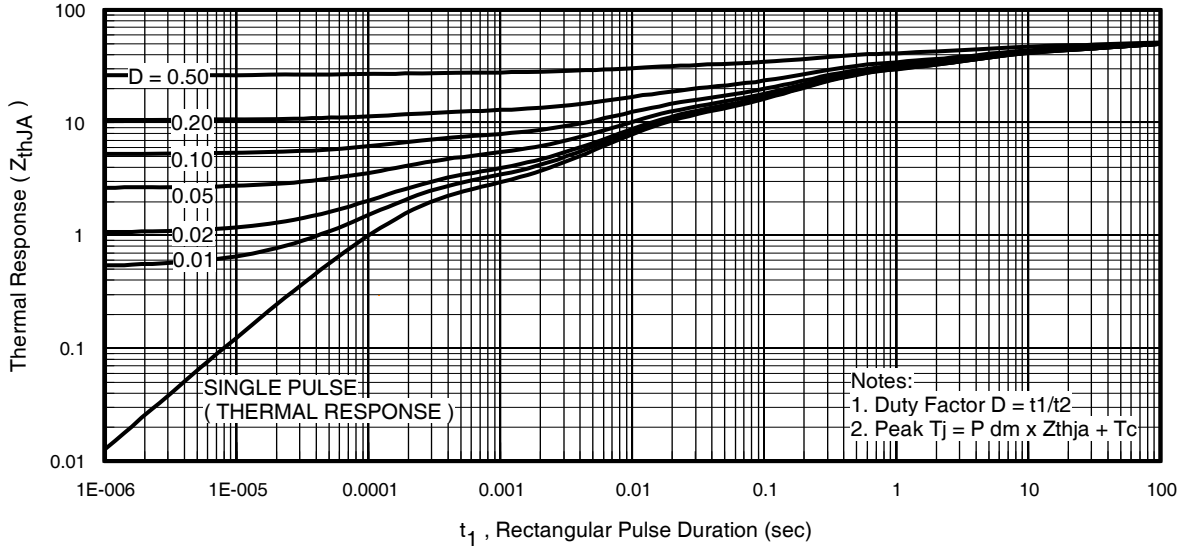

Fig 25. Maximum Effective Transient Thermal Impedance, Junction-to-Ambient (Q1)

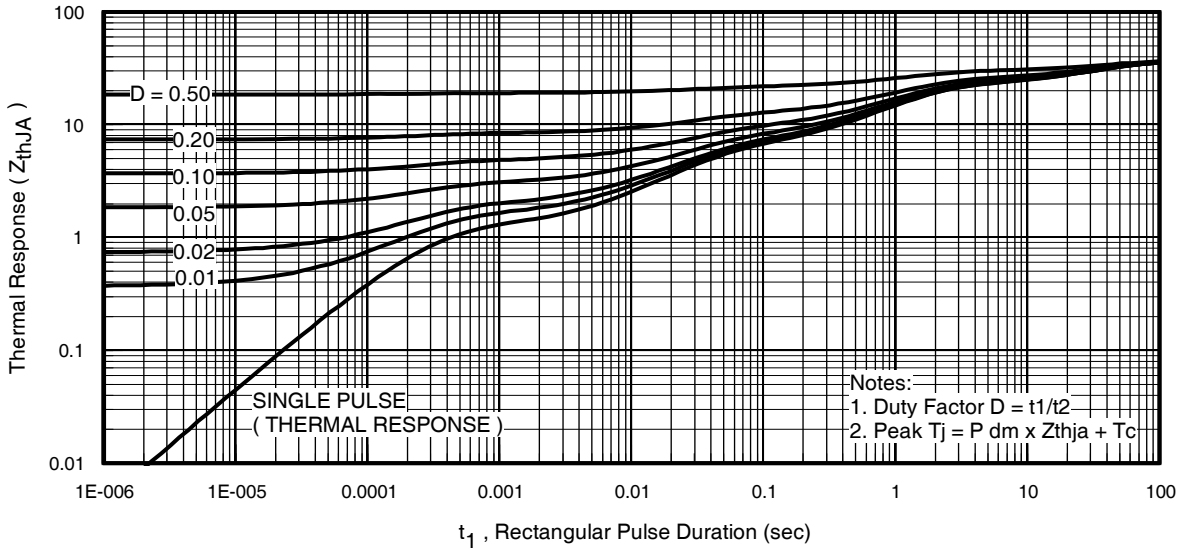
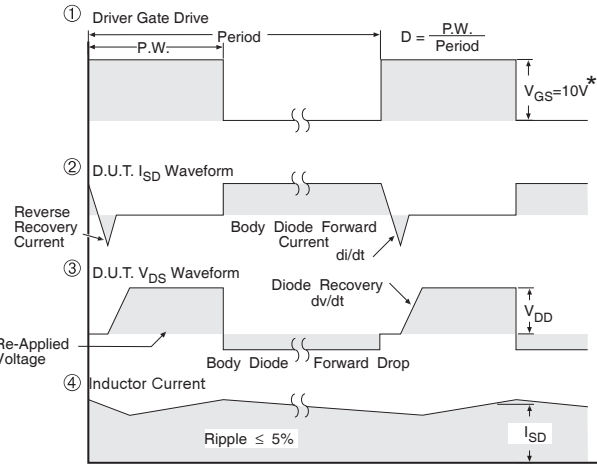
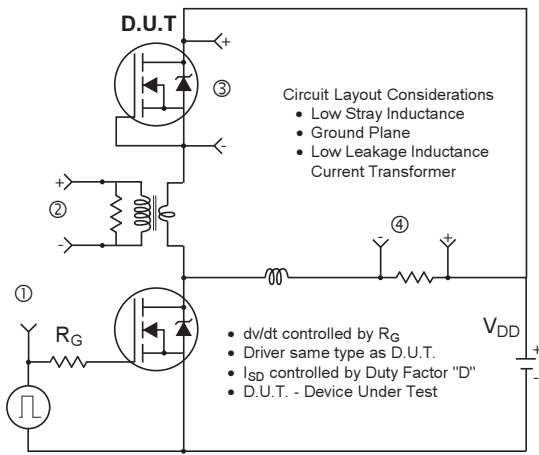

Fig 26. Maximum Effective Transient Thermal Impedance, Junction-to-Ambient (Q2)



* $V_{GS} = 5V$ for Logic Level Devices

Fig 28. Peak Diode Recovery dv/dt Test Circuit for N-Channel HEXFET® Power MOSFETs

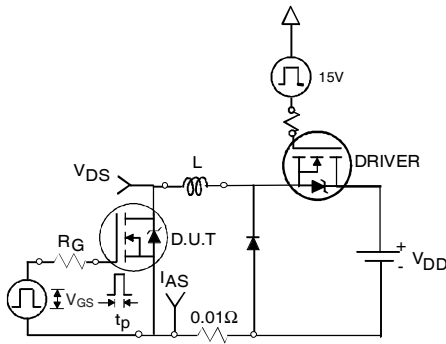

Fig 29a. Unclamped Inductive Test Circuit

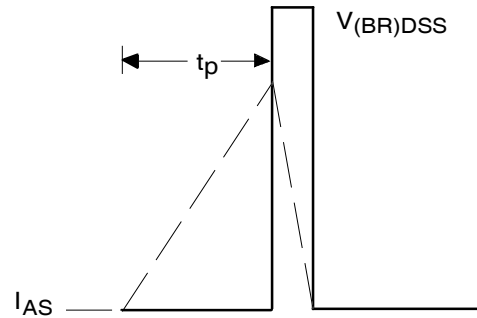

Fig 29b. Unclamped Inductive Waveforms

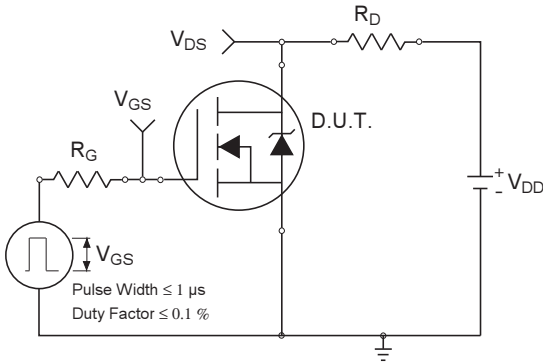

Fig 30a. Switching Time Test Circuit

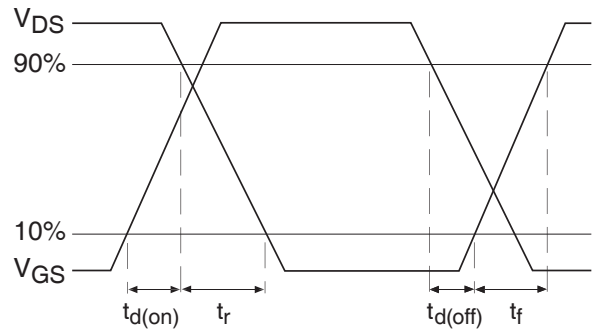

Fig 30b. Switching Time Waveforms

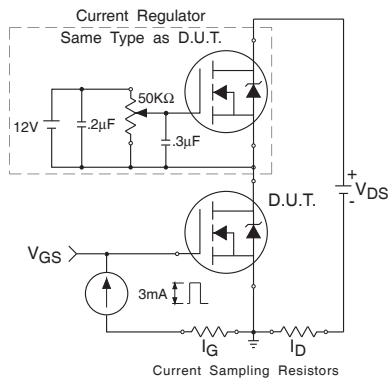

Fig 31a. Gate Charge Test Circuit

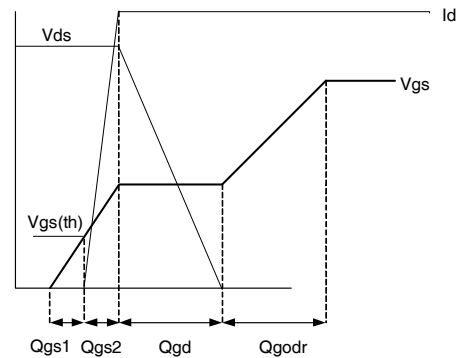
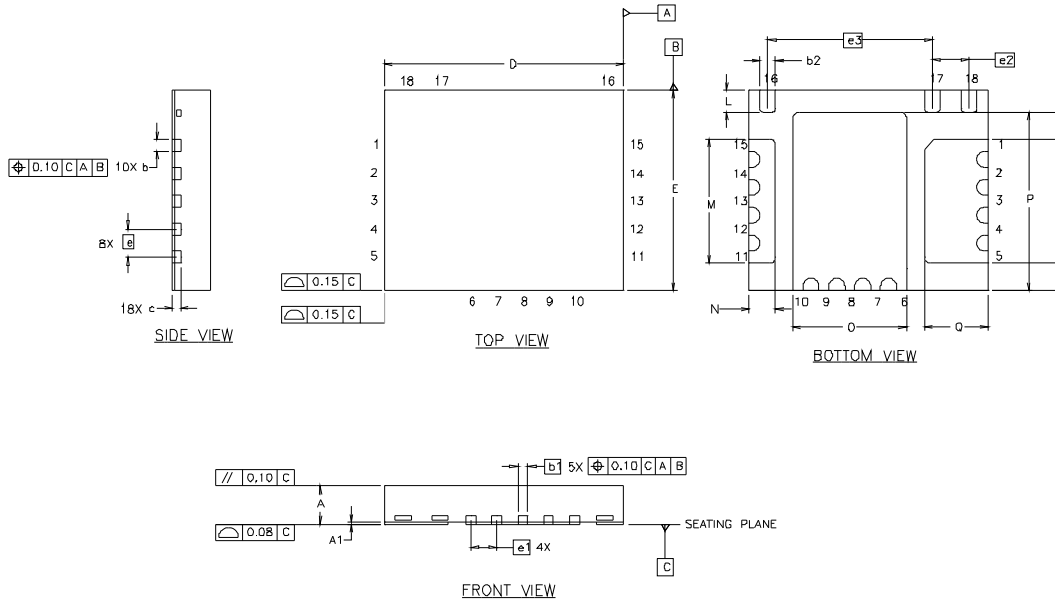

Fig 31b. Gate Charge Waveform

PQFN 5x6 Outline "C" Package Details



Outline PQFN 5X6 C

DIM	INCHES		MILLIMETERS	
	MIN	MAX	MIN	MAX
A	.0315	.0394	0.800	1.000
A1	.0000	.0020	0.000	0.050
b	.0098	.0158	0.250	0.350
b1	.0079	0.118	0.200	0.300
b2	.0138	.0177	0.350	0.450
e	.0080 REF.		0.203 REF.	
D	.2362 BASIC		6.000 BASIC	
E	.1969 BASIC		5.000 BASIC	
e	.0276 BASIC		0.700 BASIC	
e1	.0256 BASIC		0.650 BASIC	
e2	.0365 BASIC		0.926 BASIC	
e3	.1630 BASIC		4.140 BASIC	
L	.0197	.0236	0.500	0.600
M	.1201	1.240	3.050	3.150
N	.0243	.0282	.617	.717
O	.1102	1.142	2.800	2.900
P	.1732	.1772	4.400	4.500
Q	.0607	.0647	1.543	1.643
R	.0266 REF.		0.675 REF.	
S	.0266 REF.		0.675 REF.	

For footprint and stencil design recommendations, please refer to application note AN-1136 at <http://www.irf.com/technical-info/appnotes/an-1136.pdf>

PQFN 5x6 Outline "C" Part Marking

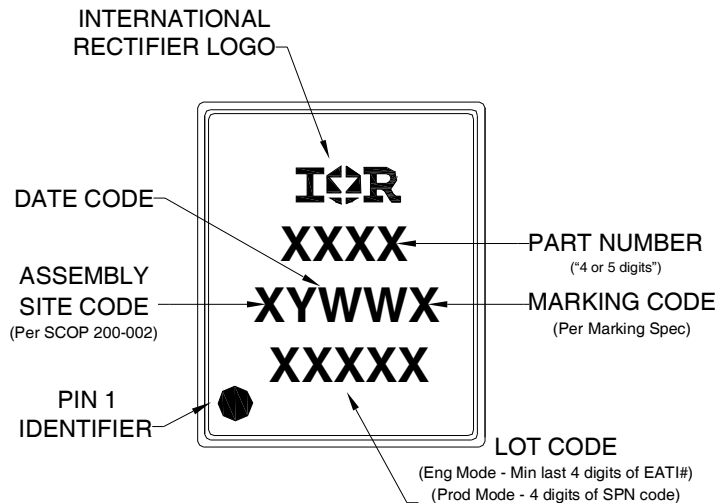

Note: For the most current drawing please refer to IR website at: <http://www.irf.com/package/>

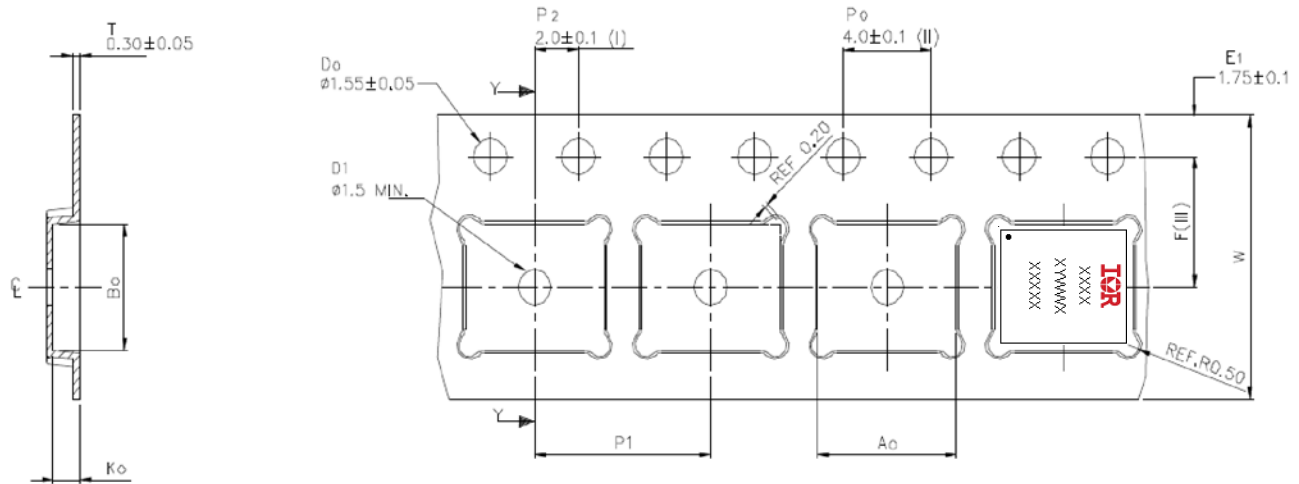
PQFN 5x6 Outline "C" Tape and Reel

SECTION Y-Y

A ₀	6.30 +/− 0.1
B ₀	5.30 +/− 0.1
K ₀	1.20 +/− 0.1
F	5.50 +/− 0.1
P ₁	8.00 +/− 0.1
W	12.00 +/− 0.3

- (I) Measured from centreline of sprocket hole to centreline of pocket.
- (II) Cumulative tolerance of 10 sprocket holes is ± 0.20 .
- (III) Measured from centreline of sprocket hole to centreline of pocket.
- (IV) Other material available.
- (V) Typical SR of form tape Max 10⁹ OHM/SQ

ALL DIMENSIONS IN MILLIMETRES UNLESS OTHERWISE STATED.

Note: For the most current drawing please refer to IR website at: <http://www.irf.com/package/>

Qualification information[†]

Qualification level	Consumer ^{††} (per JEDEC JESD47F ^{†††} guidelines)	
Moisture Sensitivity Level	PQFN 5mm x 6mm	MSL2 ^{††††} (per JEDEC J-STD-020D ^{†††})
RoHS compliant	Yes	

† Qualification standards can be found at International Rectifier's web site

<http://www.irf.com/product-info/reliability>

†† Higher qualification ratings may be available should the user have such requirements. Please contact your International Rectifier sales representative for further information:

<http://www.irf.com/whoto-call/salesrep/>

††† Applicable version of JEDEC standard at the time of product release.

†††† Higher MSL ratings may be available for the specific package types listed here. Please contact your International Rectifier sales representative for further information:

<http://www.irf.com/whoto-call/salesrep/>

Notes:

- ① Repetitive rating; pulse width limited by max. junction temperature.
- ② Starting $T_J = 25^\circ\text{C}$,
Q1: $L = 0.23\text{mH}$, $R_G = 25\Omega$, $I_{AS} = 10\text{A}$;
Q2: $L = 0.15\text{mH}$, $R_G = 25\Omega$, $I_{AS} = 21\text{A}$.
- ③ Pulse width $\leq 400\mu\text{s}$; duty cycle $\leq 2\%$.
- ④ When mounted on 1 inch square copper board.
- ⑤ R_θ is measured at T_J approximately 90°C .

Revision History

Date	Comment
1/8/2010	• Pin number on front page drawing has been corrected
7/15/2010	• MSL2 Consumer Qualification on page1 has been corrected
10/25/2011	• Link from AN-1152 to AN-1136 on page 9 has been corrected
5/9/2014	• Updated ordering information to reflect the End-Of-life (EOL) of the mini-reel option (EOL notice #259) • Updated data sheet based on corporate template.