

V_{DS}	30	V
V_{GS}	±12	V
$R_{DS(on) max}$ (@ $V_{GS} = 4.5V$)	3.5	mΩ
(@ $V_{GS} = 2.5V$)	4.5	
Q_g (typical)	41	nC
I_D (@ $T_{C(Bottom)} = 25^\circ C$)	40 Ⓞ	A

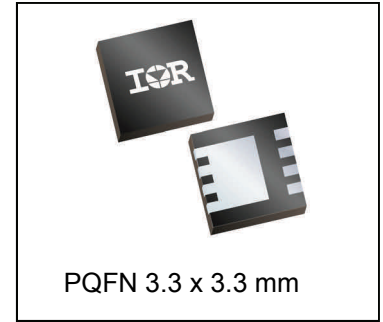
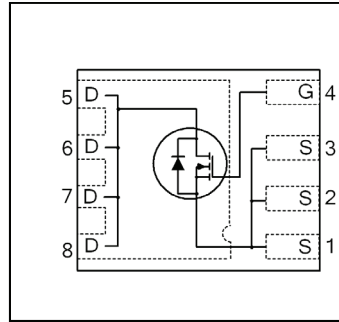

Applications

- Battery Operated DC Motor Inverter MOSFET
- Secondary Side Synchronous Rectification MOSFET

Features

Low $R_{DS(on)}$ (< 3.5mΩ)
Low Thermal Resistance to PCB (<3.4°C/W)
Low Profile (< 1.0 mm)
Industry-Standard Pinout
Compatible with Existing Surface Mount Techniques
RoHS Compliant Containing no Lead, no Bromide and no Halogen
MSL1, Industrial Qualification

results in
⇒

Benefits

Lower Conduction Losses
Enable better thermal dissipation
Increased Power Density
Multi-Vendor Compatibility
Easier Manufacturing
Environmentally Friendlier
Increased Reliability

Orderable part number	Package Type	Standard Pack		Note
		Form	Quantity	
IRLHM630TRPbF	PQFN 3.3mm x 3.3mm	Tape and Reel	4000	
IRLHM630TR2PbF	PQFN 3.3mm x 3.3mm	Tape and Reel	400	EOL notice # 259

Absolute Maximum Ratings

	Parameter	Max.	Units
V_{DS}	Drain-to-Source Voltage	30	V
V_{GS}	Gate-to-Source Voltage	± 12	
$I_D @ T_A = 25^\circ C$	Continuous Drain Current, $V_{GS} @ 4.5V$	21	A
$I_D @ T_A = 70^\circ C$	Continuous Drain Current, $V_{GS} @ 4.5V$	17	
$I_D @ T_{C(Bottom)} = 25^\circ C$	Continuous Drain Current, $V_{GS} @ 4.5V$	40Ⓞ	
$I_D @ T_{C(Bottom)} = 100^\circ C$	Continuous Drain Current, $V_{GS} @ 4.5V$	40Ⓞ	
I_{DM}	Pulsed Drain Current ①	160	
$P_D @ T_A = 25^\circ C$	Power Dissipation ⑤	2.7	W
$P_D @ T_{C(Bottom)} = 25^\circ C$	Power Dissipation ⑤	37	
	Linear Derating Factor ⑤	0.022	W/°C
T_J T_{STG}	Operating Junction and Storage Temperature Range	-55 to + 150	°C

Notes ① through ⑥ are on page 9

Static @ T_J = 25°C (unless otherwise specified)

	Parameter	Min.	Typ.	Max.	Units	Conditions
BV _{DSS}	Drain-to-Source Breakdown Voltage	30	—	—	V	V _{GS} = 0V, I _D = 250μA
ΔBV _{DSS} /ΔT _J	Breakdown Voltage Temp. Coefficient	—	2.1	—	mV/°C	Reference to 25°C, I _D = 1mA
R _{DS(on)}	Static Drain-to-Source On-Resistance	—	2.2	3.2	mΩ	V _{GS} = 10V, I _D = 20A ③
		—	2.5	3.5		V _{GS} = 4.5V, I _D = 20A ③
		—	3.5	4.5		V _{GS} = 2.5V, I _D = 20A ③
V _{GS(th)}	Gate Threshold Voltage	0.5	0.8	1.1	V	V _{DS} = V _{GS} , I _D = 50μA
ΔV _{GS(th)}	Gate Threshold Voltage Coefficient	—	-3.8	—	mV/°C	
I _{DSS}	Drain-to-Source Leakage Current	—	—	1	μA	V _{DS} = 24V, V _{GS} = 0V
		—	—	150		V _{DS} = 24V, V _{GS} = 0V, T _J = 125°C
I _{GSS}	Gate-to-Source Forward Leakage	—	—	100	nA	V _{GS} = 12V
	Gate-to-Source Reverse Leakage	—	—	-100		V _{GS} = -12V
g _{fs}	Forward Transconductance	140	—	—	S	V _{DS} = 10V, I _D = 20A
Q _g	Total Gate Charge	—	41	62	nC	V _{DS} = 15V
Q _{gs}	Gate-to-Source Charge	—	4.6	—		V _{GS} = 4.5V
Q _{gd}	Gate-to-Drain Charge	—	14	—		I _D = 20A (See Fig.17 & 18)
R _G	Gate Resistance	—	2.6	—	Ω	
t _{d(on)}	Turn-On Delay Time	—	9.1	—	ns	V _{DD} = 10V, V _{GS} = 4.5V
t _r	Rise Time	—	32	—		I _D = 20A
t _{d(off)}	Turn-Off Delay Time	—	65	—		R _G = 1.0Ω
t _f	Fall Time	—	43	—		See Fig.15
C _{iss}	Input Capacitance	—	3170	—	pF	V _{GS} = 0V
C _{oss}	Output Capacitance	—	330	—		V _{DS} = 25V
C _{rss}	Reverse Transfer Capacitance	—	250	—		f = 1.0MHz

Avalanche Characteristics

	Parameter	Typ.	Max.	Units
E _{AS} (Thermally limited)	Single Pulse Avalanche Energy ②	—	80	mJ
I _{AR}	Avalanche Current ①	—	20	A

Diode Characteristics

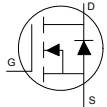
	Parameter	Min.	Typ.	Max.	Units	Conditions
I _S	Continuous Source Current (Body Diode)	—	—	40⑥	A	MOSFET symbol showing the integral reverse p-n junction diode. 
I _{SM}	Pulsed Source Current (Body Diode) ①	—	—	160		
V _{SD}	Diode Forward Voltage	—	—	1.2	V	T _J = 25°C, I _S = 20A, V _{GS} = 0V ③
t _{rr}	Reverse Recovery Time	—	20	30	ns	T _J = 25°C, I _F = 20A, V _{DD} = 15V
Q _{rr}	Reverse Recovery Charge	—	30	45	nC	di/dt = 400A/μs ③

Thermal Resistance

	Parameter	Typ.	Max.	Units
R _{θJC} (Bottom)	Junction-to-Case ④	—	3.4	°C/W
R _{θJC} (Top)	Junction-to-Case ④	—	37	
R _{θJA}	Junction-to-Ambient ⑤	—	46	
R _{θJA} (<10s)	Junction-to-Ambient ⑤	—	31	

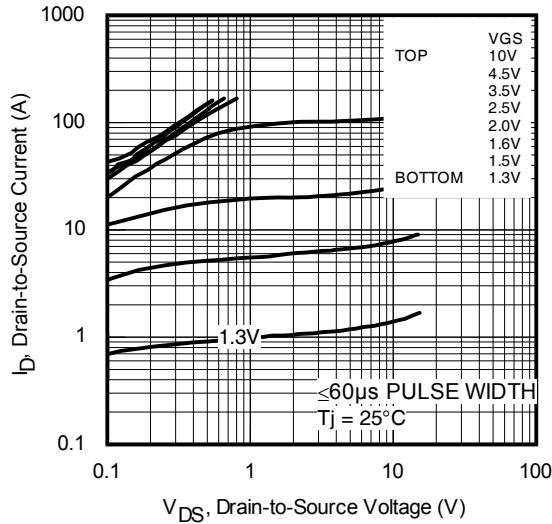

Fig 1. Typical Output Characteristics

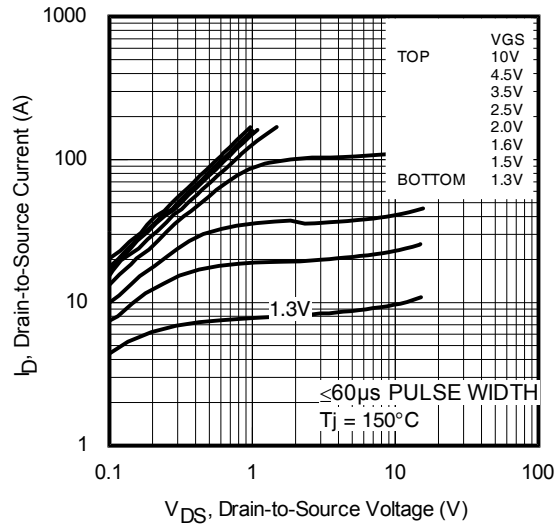

Fig 2. Typical Output Characteristics

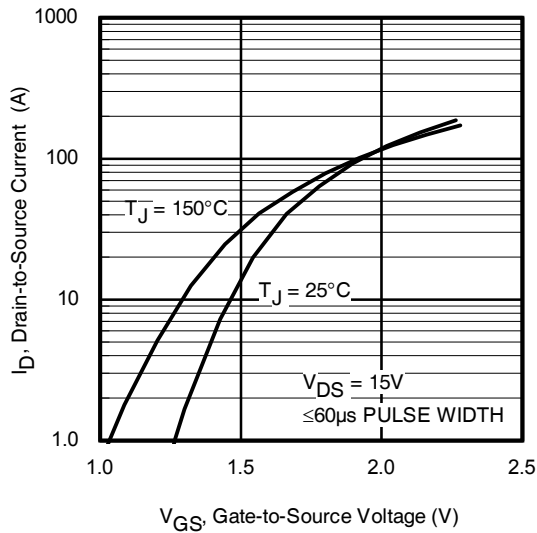

Fig 3. Typical Transfer Characteristics

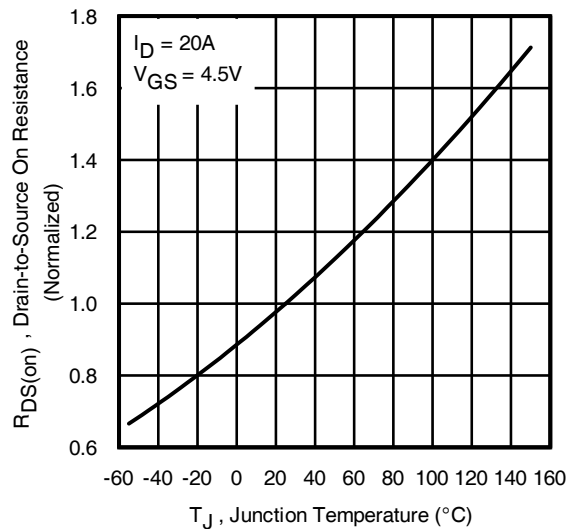

Fig 4. Normalized On-Resistance vs. Temperature

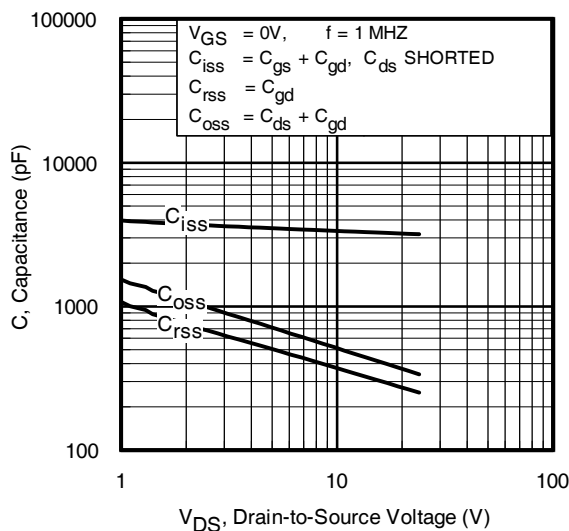

Fig 5. Typical Capacitance vs. Drain-to-Source Voltage

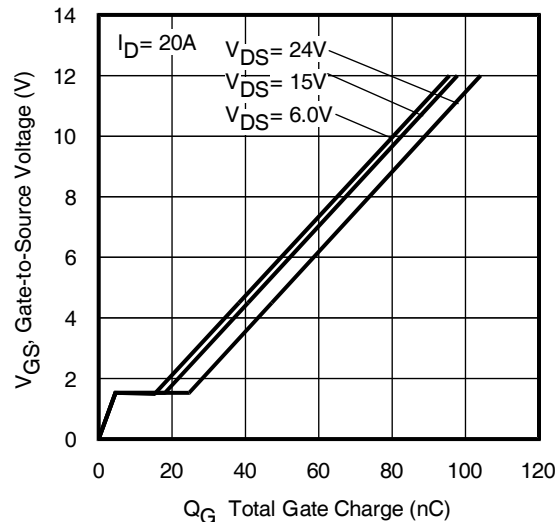

Fig 6. Typical Gate Charge vs. Gate-to-Source Voltage

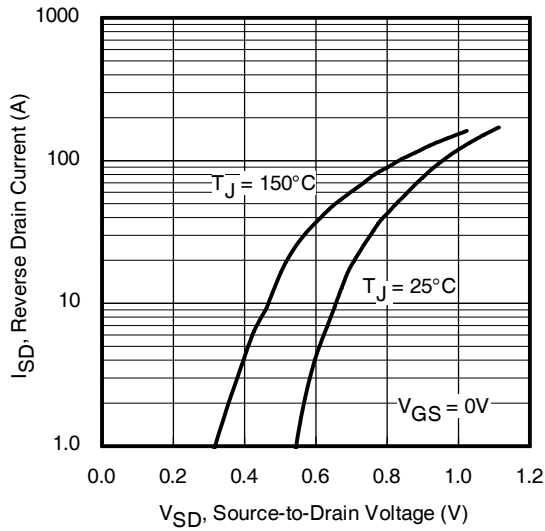

Fig 7. Typical Source-Drain Diode Forward Voltage

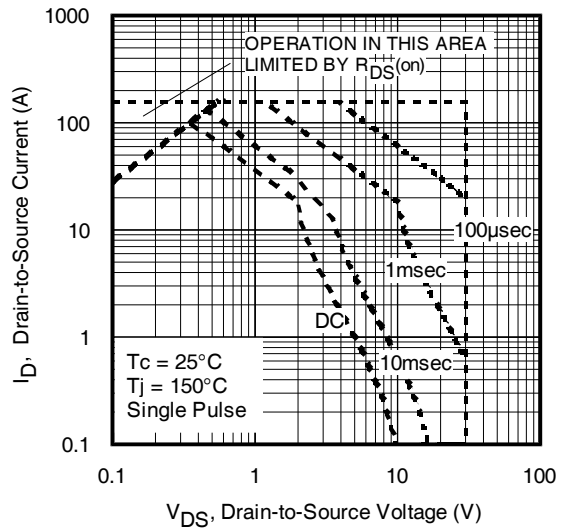

Fig 8. Maximum Safe Operating Area

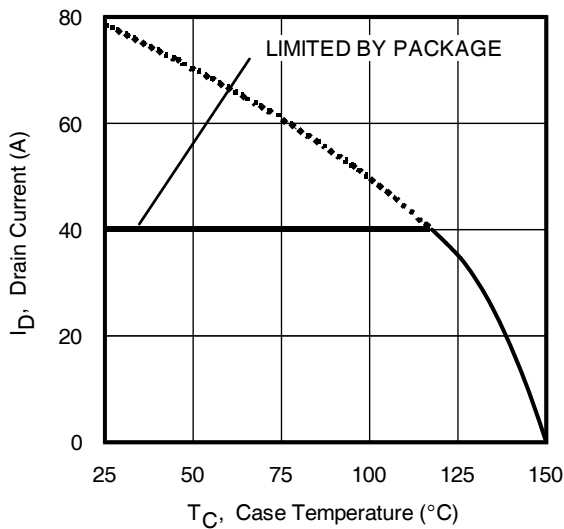

Fig 9. Maximum Drain Current vs. Case Temperature

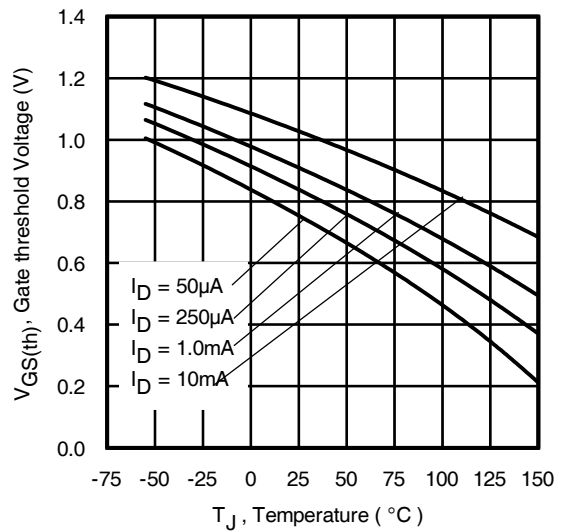

Fig 10. Threshold Voltage Vs. Temperature

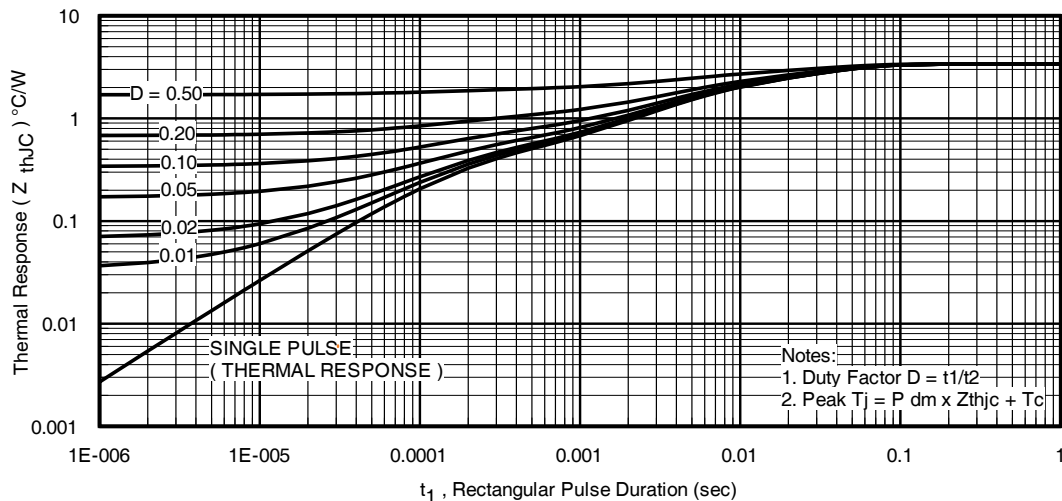

Fig 11. Maximum Effective Transient Thermal Impedance, Junction-to-Case

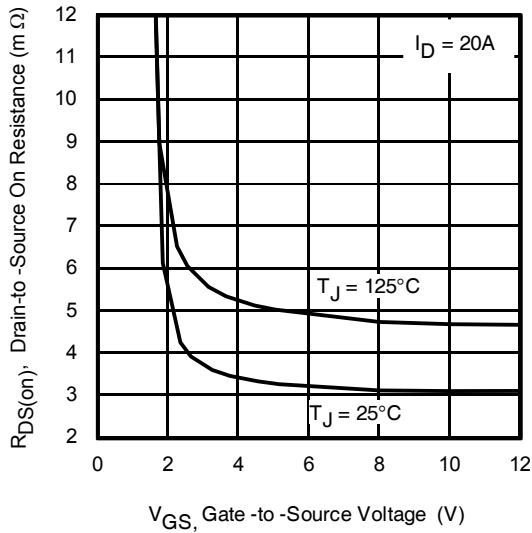

Fig 12. On-Resistance vs. Gate Voltage

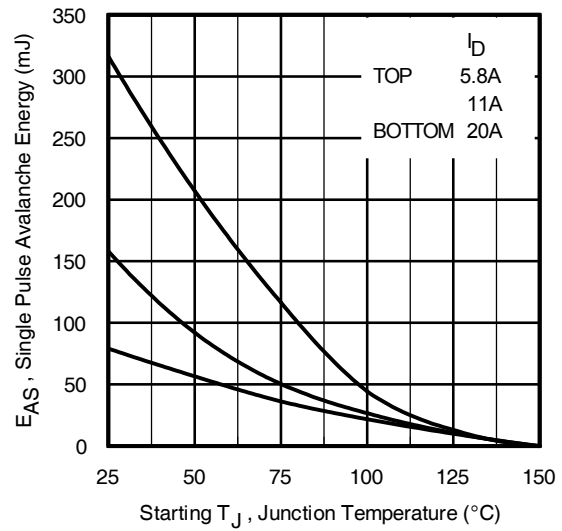

Fig 13. Maximum Avalanche Energy vs. Drain Current

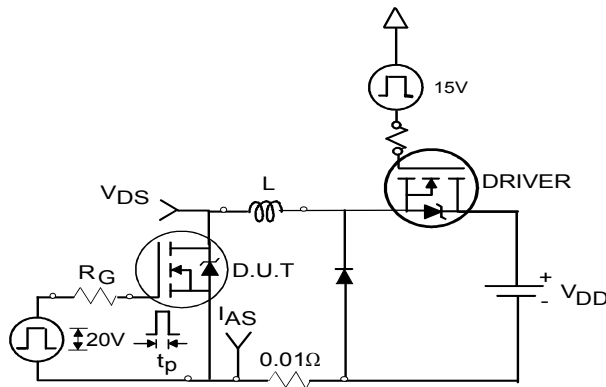

Fig 14a. Unclamped Inductive Test Circuit

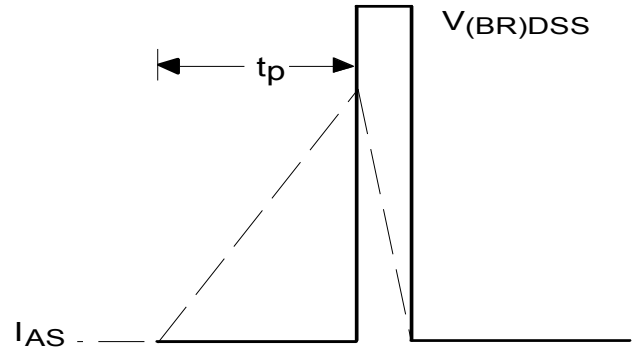

Fig 14b. Unclamped Inductive Waveforms

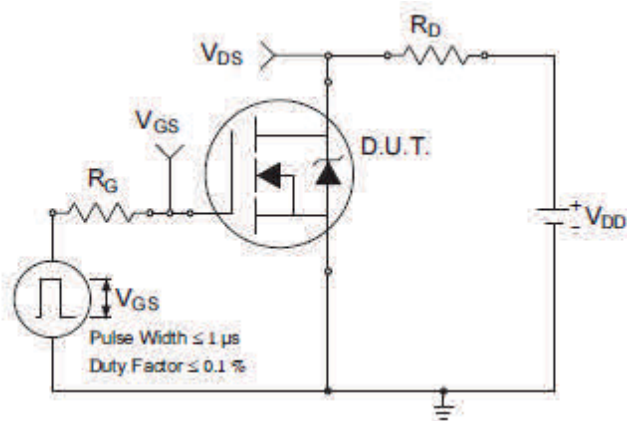

Fig 15a. Switching Time Test Circuit

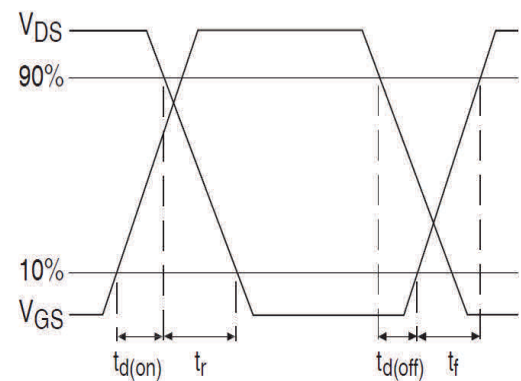

Fig 15b. Switching Time Waveforms

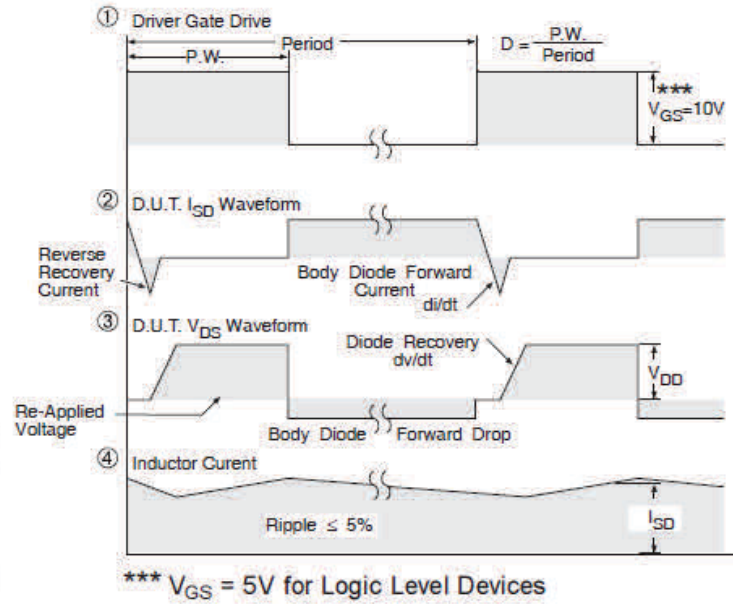
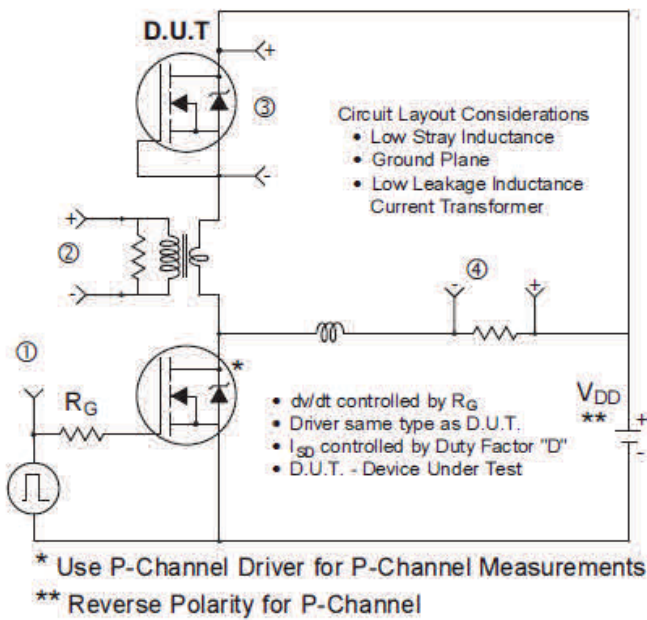

Fig 16. Peak Diode Recovery dv/dt Test Circuit for N-Channel HEXFET® Power MOSFETs

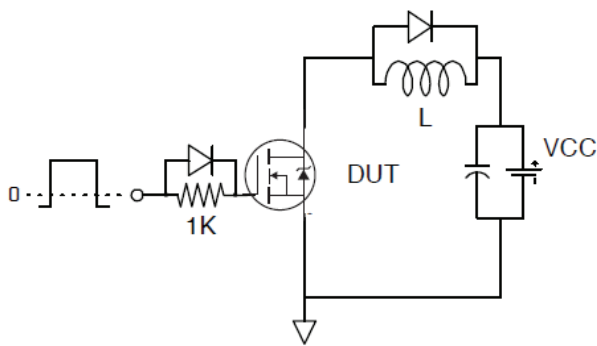

Fig 17. Gate Charge Test Circuit

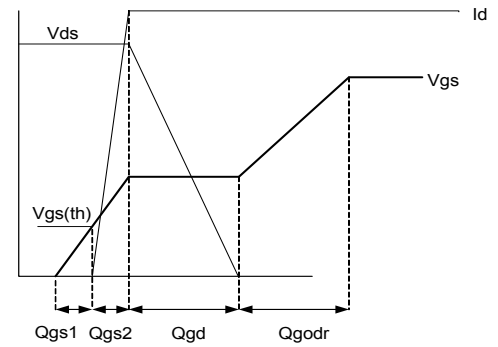
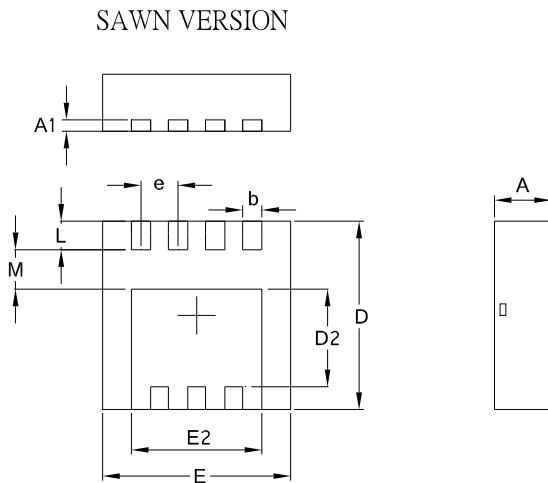

Fig 18. Gate Charge Waveform

PQFN 3.3 x 3.3 Outline “B” Package Details



SYMBOL	COMMON			
	MM		INCH	
	MIN.	MAX.	MIN.	MAX.
A	0.70	1.05	0.0276	0.0413
A1	0.12	0.39	0.0047	0.0154
b	0.25	0.39	0.0098	0.0154
D	3.20	3.45	0.1260	0.1358
D1	3.00	3.20	0.1181	0.1417
D2	1.69	2.20	0.0665	0.0866
E	3.20	3.40	0.1260	0.1339
E1	3.00	3.20	0.1181	0.1417
E2	2.15	2.59	0.0846	0.1020
e	0.65 BSC		0.0256 BSC	
L	0.15	0.55	0.0059	0.0217
M	0.59	—	0.0232	—
O	9Deg	12Deg	9Deg	12Deg

PQFN 3.3 x 3.3 Outline “G” Package Details

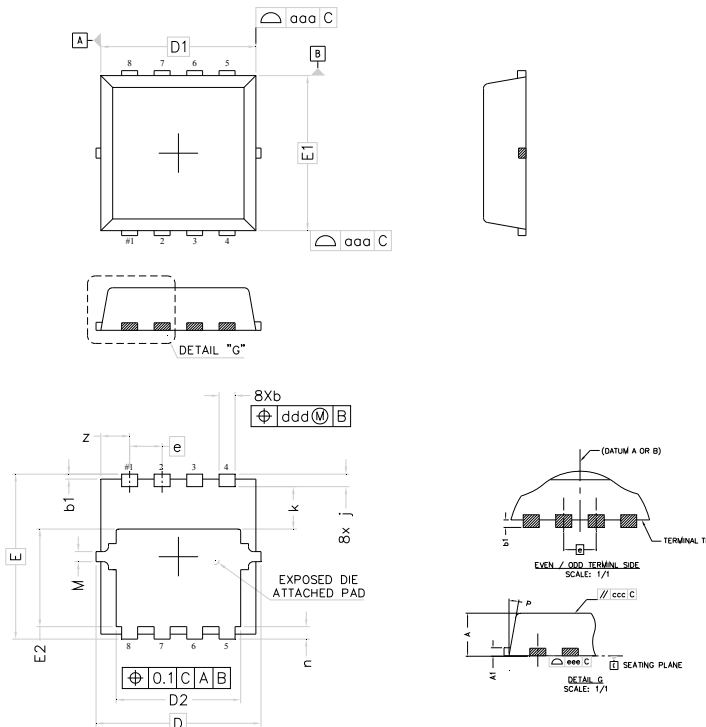

DIM	MILLIMETERS		INCHES	
	MIN	MAX	MIN	MAX
A	0.80	0.90	.0315	.0354
A1	0.12	0.22	.0047	.0086
b	0.22	0.42	.0087	.0165
b1	0.05	0.15	.0020	.0059
D	3.30 BSC		.1299 BSC	
D1	3.10 BSC		.1220 BSC	
D2	2.29	2.69	.0902	.1059
E	3.30 BSC		.1299 BSC	
E1	3.10 BSC		.1220 BSC	
E2	1.85	2.05	.0728	.0807
e	0.65 BSC		.0255 BSC	
j	0.15	0.35	.0059	.0137
k	0.75	0.95	.0295	.0374
n	0.15	0.35	.0059	.0137
M	NOM.	0.20	NOM.	.0078
P	9°	11°	9°	11°

For more information on board mounting, including footprint and stencil recommendation, please refer to application note AN-1136: <http://www.irf.com/technical-info/appnotes/an-1136.pdf>

For more information on package inspection techniques, please refer to application note AN-1154:

<http://www.irf.com/technical-info/appnotes/an-1154.pdf>

PQFN 3.3 x 3.3 Part Marking

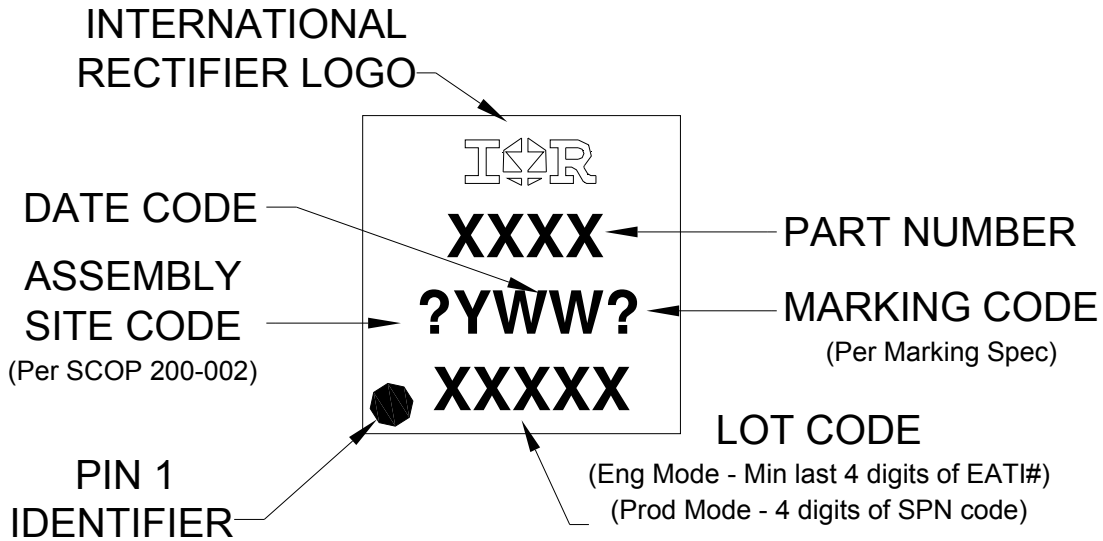

Note: For the most current drawing please refer to IR website at <http://www.irf.com/package/>

PQFN 3.3 x 3.3 Tape and Reel

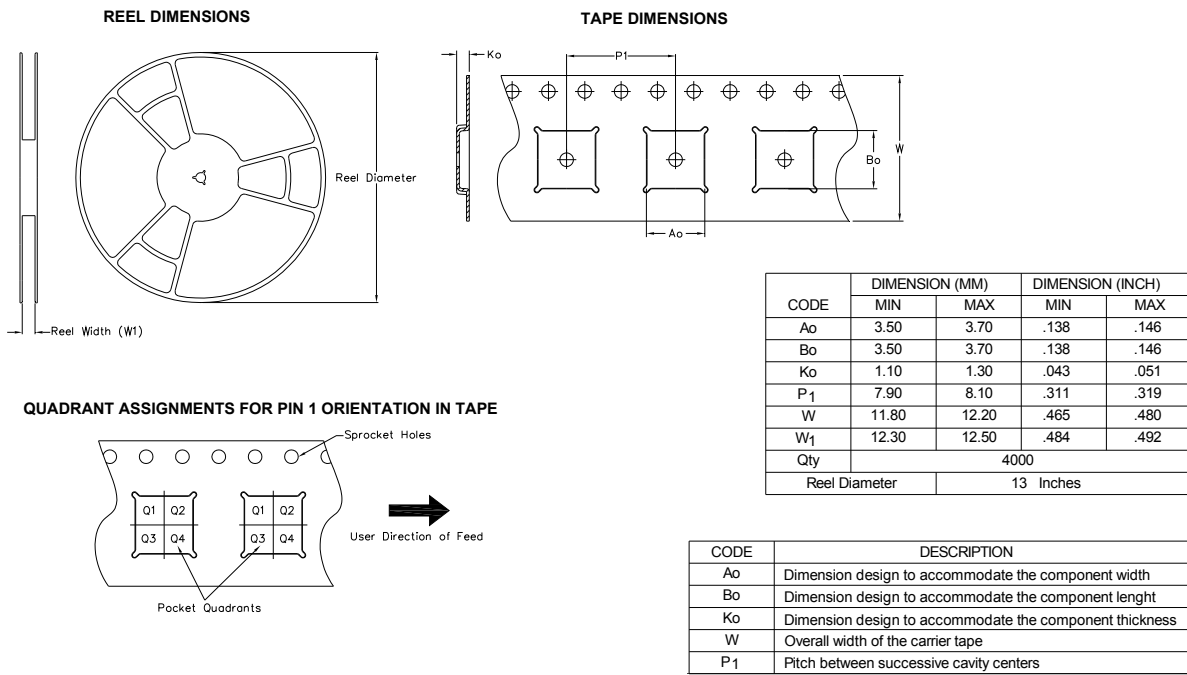

Note: For the most current drawing please refer to IR website at <http://www.irf.com/package/>

Qualification Information†

Qualification Level	Industrial (per JEDEC JESD47F†† guidelines)	
Moisture Sensitivity Level	PQFN 3.3mm x 3.3mm	MSL1 (per JEDEC J-STD-020D††)
RoHS Compliant	Yes	

† Qualification standards can be found at International Rectifier's web site: <http://www.irf.com/product-info/reliability>

†† Applicable version of JEDEC standard at the time of product release.

Notes:

- ① Repetitive rating; pulse width limited by max. junction temperature.
- ② Starting $T_J = 25^\circ\text{C}$, $L = 0.59\text{mH}$, $R_G = 50\Omega$, $I_{AS} = 12\text{A}$.
- ③ Pulse width $\leq 400\mu\text{s}$; duty cycle $\leq 2\%$.
- ④ R_θ is measured at T_J of approximately 90°C .
- ⑤ When mounted on 1 inch square PCB (FR-4). Please refer to AN-994 for more details:
<http://www.irf.com/technical-info/appnotes/an-994.pdf>
- ⑥ Calculated continuous current based on maximum allowable junction temperature. Package is limited to 40A by production test capability.

Revision History	
Date	Comments
1/14/2014	<ul style="list-style-type: none"> • Updated ordering information to reflect the End-Of-life (EOL) of the mini-reel option (EOL notice #259) • Updated data sheet with new IR corporate template
5/29/2015	<ul style="list-style-type: none"> • Added R_{dson} typical = "1.5mΩ", Max = "2.2mΩ" @ $V_{\text{GS}}=10\text{V}, I_{\text{D}}=20\text{A}$ on page 2. • Updated R_{dson} typical from "2mΩ" to "1.8mΩ" @ $V_{\text{GS}}=4.5\text{V}, I_{\text{D}}=20\text{A}$ on page 2. • Updated package outline and tape and Reel on page 7 & 8.
9/25/2015	<ul style="list-style-type: none"> • Updated package outline to reflect the PCN # (67-PCN90-Public-R2) for "option B" and added package outline for "option G" on page 7 • Updated "IFX" logo on all pages. • Corrected typo for "Gate Charge, Switch time & trr" test condition on page 2.