



# MCP14A0153/4/5

## 1.5A Dual MOSFET Driver with Low Threshold Input and Enable

### Features

- High Peak Output Current: 1.5A (typical)
- Wide Input Supply Voltage Operating Range:
  - 4.5V to 18V
- Low Shoot-Through/Cross-Conduction Current in Output Stage
- High Capacitive Load Drive Capability:
  - 1000 pF in 11.5 ns (typical)
- Short Delay Times: 25 ns ( $t_{D1}$ ), 24 ns ( $t_{D2}$ ) (typical)
- Low Supply Current: 750  $\mu$ A (typical)
- Low-Voltage Threshold Input and Enable with Hysteresis
- Latch-up Protected: Withstands 500 mA Reverse Current
- Space-Saving Packages:
  - 8-Lead MSOP
  - 8-Lead SOIC
  - 8-Lead 2x3 TDFN

### Applications

- Switch-Mode Power Supplies (SMPS)
- Pulse Transformer Drive
- Line Drivers
- Level Translator
- Motor and Solenoid Drive

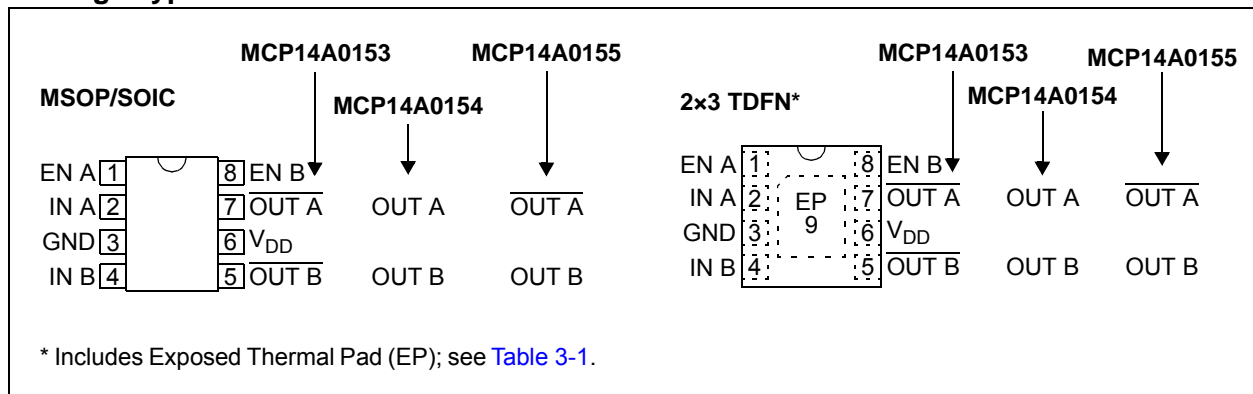
### General Description

The MCP14A0153/4/5 devices are high-speed dual MOSFET drivers that are capable of providing up to 1.5A of peak current while operating from a single 4.5V to 18V supply. There are three output configurations available: dual inverting (MCP14A0153), dual non-inverting (MCP14A0154) and complementary (MCP14A0155). These devices feature low shoot-through current, matched rise and fall times and short propagation delays, which make them ideal for high switching frequency applications.

The MCP14A0153/4/5 family of devices offers enhanced control with enable functionality. The active-high enable pins can be driven low to drive the corresponding outputs of the MCP14A0153/4/5 low, regardless of the status of the input pin. An integrated pull-up resistor allows the user to leave the enable pins floating for standard operation.

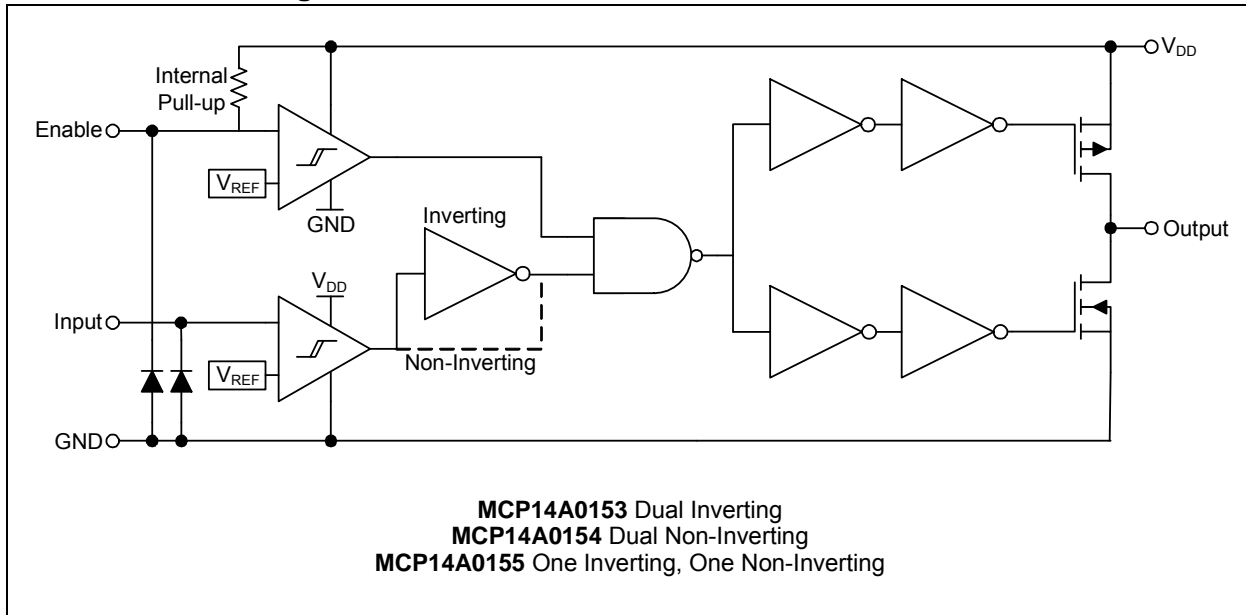
These devices are highly latch-up resistant under any condition within their power and voltage ratings. They can accept up to 500 mA of reverse current being forced back into their outputs without damage or logic upset. All terminals are fully protected against Electrostatic Discharge (ESD), up to 2 kV (HBM) and 200 V (MM).

### Package Types



# MCP14A0153/4/5

## Functional Block Diagram



## 1.0 ELECTRICAL CHARACTERISTICS

### Absolute Maximum Ratings†

$V_{DD}$ , Supply Voltage.....	+20V
$V_{IN}$ , Input Voltage..... ( $V_{DD} + 0.3V$ ) to ( $GND - 0.3V$ )	
$V_{EN}$ , Enable Voltage..... ( $V_{DD} + 0.3V$ ) to ( $GND - 0.3V$ )	
Package Power Dissipation ( $T_A = +50^{\circ}C$ )	
8L MSOP .....	0.63W
8L SOIC .....	1.00W
8L 2 x 3 TDFN.....	1.86W
ESD Protection on all Pins .....	2 kV (HBM)
.....	200V (MM)

† **Notice:** Stresses above those listed under “Maximum Ratings” may cause permanent damage to the device. This is a stress rating only and functional operation of the device at those or any other conditions above those indicated in the operational sections of this specification is not intended. Exposure to maximum rating conditions for extended periods may affect device reliability.

### DC CHARACTERISTICS

Electrical Specifications: Unless otherwise noted, $T_A = +25^{\circ}C$ , with $4.5V \leq V_{DD} \leq 18V$ .						
Parameters	Sym.	Min.	Typ.	Max.	Units	Conditions
<b>Input</b>						
Input Voltage Range	$V_{IN}$	$GND - 0.3$	—	$V_{DD} + 0.3$	V	
Logic ‘1’ High Input Voltage	$V_{IH}$	2.0	1.6	—	V	
Logic ‘0’ Low Input Voltage	$V_{IL}$	—	1.2	0.8	V	
Input Voltage Hysteresis	$V_{HYST(IN)}$	—	0.4	—	V	
Input Current	$I_{IN}$	-1	—	+1	$\mu A$	$0V \leq V_{IN} \leq V_{DD}$
<b>Enable</b>						
Enable Voltage Range	$V_{EN}$	$GND - 0.3V$	—	$V_{DD} + 0.3$	V	
Logic ‘1’ High Enable Voltage	$V_{EH}$	2	1.6	—	V	
Logic ‘0’ Low Enable Voltage	$V_{EL}$	—	1.2	0.8	V	
Enable Voltage Hysteresis	$V_{HYST(EN)}$	—	0.4	—	V	
Enable Pin Pull-up Resistance	$R_{ENBL}$	—	1.8	—	$M\Omega$	$V_{DD} = 18V, EN = GND$
Enable Input Current	$I_{EN}$	—	10	—	$\mu A$	$V_{DD} = 18V, EN = GND$
Propagation Delay	$t_{D3}$	—	25	32	ns	$V_{DD} = 18V, V_{EN} = 5V$ , see <a href="#">Figure 4-3 (Note 1)</a>
Propagation Delay	$t_{D4}$	—	24	31	ns	$V_{DD} = 18V, V_{EN} = 5V$ , see <a href="#">Figure 4-3 (Note 1)</a>
<b>Output</b>						
High Output Voltage	$V_{OH}$	$V_{DD} - 0.025$	—	—	V	$I_{OUT} = 0A$
Low Output Voltage	$V_{OL}$	—	—	0.025	V	$I_{OUT} = 0A$
Output Resistance, High	$R_{OH}$	—	4.5	6.5	$\Omega$	$I_{OUT} = 10 mA, V_{DD} = 18V$
Output Resistance, Low	$R_{OL}$	—	3.0	4.5	$\Omega$	$I_{OUT} = 10 mA, V_{DD} = 18V$
Peak Output Current	$I_{PK}$	—	1.5	—	A	$V_{DD} = 18V$ ( <a href="#">Note 1</a> )
Latch-up Protection Withstand Reverse Current	$I_{REV}$	0.5	—	—	A	Duty cycle $\leq 2\%$ , $t \leq 300 \mu s$ ( <a href="#">Note 1</a> )

**Note 1:** Tested during characterization, not production tested.

# MCP14A0153/4/5

## DC CHARACTERISTICS (CONTINUED)

Electrical Specifications: Unless otherwise noted, $T_A = +25^\circ\text{C}$ , with $4.5\text{V} \leq V_{DD} \leq 18\text{V}$ .						
Parameters	Sym.	Min.	Typ.	Max.	Units	Conditions
<b>Switching Time<sup>(1)</sup></b>						
Rise Time	$t_R$	—	11.5	18.5	ns	$V_{DD} = 18\text{V}$ , $C_L = 1000\text{ pF}$ , see Figure 4-1 and Figure 4-2 (Note 1)
Fall Time	$t_F$	—	10	17	ns	$V_{DD} = 18\text{V}$ , $C_L = 1000\text{ pF}$ , see Figure 4-1 and Figure 4-2 (Note 1)
Delay Time	$t_{D1}$	—	25	32	ns	$V_{DD} = 18\text{V}$ , $V_{IN} = 5\text{V}$ , see Figure 4-1 and Figure 4-2 (Note 1)
	$t_{D2}$	—	24	31	ns	$V_{DD} = 18\text{V}$ , $V_{IN} = 5\text{V}$ , see Figure 4-1 and Figure 4-2 (Note 1)
<b>Power Supply</b>						
Supply Voltage	$V_{DD}$	4.5	—	18	V	
Power Supply Current	$I_{DD}$	—	675	1120	$\mu\text{A}$	$V_{INA/B} = 3\text{V}$ , $V_{ENA/B} = 3\text{V}$
	$I_{DD}$	—	715	1160	$\mu\text{A}$	$V_{INA/B} = 0\text{V}$ , $V_{ENA/B} = 3\text{V}$
	$I_{DD}$	—	715	1160	$\mu\text{A}$	$V_{INA/B} = 3\text{V}$ , $V_{ENA/B} = 0\text{V}$
	$I_{DD}$	—	750	1200	$\mu\text{A}$	$V_{INA/B} = 0\text{V}$ , $V_{ENA/B} = 0\text{V}$

Note 1: Tested during characterization, not production tested.

## DC CHARACTERISTICS (OVER OPERATING TEMPERATURE RANGE)<sup>(1)</sup>

Electrical Specifications: Unless otherwise indicated, over the operating range with $4.5\text{V} \leq V_{DD} \leq 18\text{V}$ .						
Parameters	Sym.	Min.	Typ.	Max.	Units	Conditions
<b>Input</b>						
Input Voltage Range	$V_{IN}$	$\text{GND} - 0.3\text{V}$	—	$V_{DD} + 0.3$	V	
Logic '1' High Input Voltage	$V_{IH}$	2.0	1.6	—	V	
Logic '0' Low Input Voltage	$V_{IL}$	—	1.2	1.8	V	
Input Voltage Hysteresis	$V_{HYST(IN)}$	—	0.4	—	V	
Input Current	$I_{IN}$	-10	—	+10	$\mu\text{A}$	$0\text{V} \leq V_{IN} \leq V_{DD}$
<b>Enable</b>						
Enable Voltage Range	$V_{EN}$	$\text{GND} - 0.3\text{V}$	—	$V_{DD} + 0.3$	V	
Logic '1' High Enable Voltage	$V_{EH}$	2.0	1.6	—	V	
Logic '0' Low Enable Voltage	$V_{EL}$	—	1.2	1.8	V	
Enable Voltage Hysteresis	$V_{HYST(EN)}$	—	0.4	—	V	
Enable Input Current	$I_{EN}$	—	12	—	$\mu\text{A}$	$V_{DD} = 18\text{V}$ , $\text{EN} = \text{GND}$
Propagation Delay	$t_{D3}$	—	28	35	ns	$V_{DD} = 18\text{V}$ , $V_{EN} = 5\text{V}$ , $T_A = +125^\circ\text{C}$ , see Figure 4-3
Propagation Delay	$t_{D4}$	—	27	34	ns	$V_{DD} = 18\text{V}$ , $V_{EN} = 5\text{V}$ , $T_A = +125^\circ\text{C}$ , see Figure 4-3

Note 1: Tested during characterization, not production tested.

## DC CHARACTERISTICS (OVER OPERATING TEMPERATURE RANGE)<sup>(1)</sup> (CONTINUED)

Electrical Specifications: Unless otherwise indicated, over the operating range with $4.5V \leq V_{DD} \leq 18V$ .						
Parameters	Sym.	Min.	Typ.	Max.	Units	Conditions
<b>Output</b>						
High Output Voltage	$V_{OH}$	$V_{DD} - 0.025$	—	—	V	DC Test
Low Output Voltage	$V_{OL}$	—	—	0.025	V	DC Test
Output Resistance, High	$R_{OH}$	—	—	9	$\Omega$	$I_{OUT} = 10 \text{ mA}$ , $V_{DD} = 18V$
Output Resistance, Low	$R_{OL}$	—	—	6.5	$\Omega$	$I_{OUT} = 10 \text{ mA}$ , $V_{DD} = 18V$
<b>Switching Time (Note 1)</b>						
Rise Time	$t_R$	—	14	21	ns	$V_{DD} = 18V$ , $C_L = 1000 \text{ pF}$ , $T_A = +125^\circ\text{C}$ , see Figure 4-1 and Figure 4-2
Fall Time	$t_F$	—	13	20	ns	$V_{DD} = 18V$ , $C_L = 1000 \text{ pF}$ , $T_A = +125^\circ\text{C}$ , see Figure 4-1 and Figure 4-2
Delay Time	$t_{D1}$	—	28	35	ns	$V_{DD} = 18V$ , $V_{IN} = 5V$ , $T_A = +125^\circ\text{C}$ , see Figure 4-1 and Figure 4-2
	$t_{D2}$	—	27	34	ns	$V_{DD} = 18V$ , $V_{IN} = 5V$ , $T_A = +125^\circ\text{C}$ , see Figure 4-1 and Figure 4-2
<b>Power Supply</b>						
Supply Voltage	$V_{DD}$	4.5	—	18	V	
Power Supply Current	$I_{DD}$	—	—	1520	$\mu\text{A}$	$V_{IN} = 3V$ , $V_{EN} = 3V$
	$I_{DD}$	—	—	1560	$\mu\text{A}$	$V_{IN} = 0V$ , $V_{EN} = 3V$
	$I_{DD}$	—	—	1560	$\mu\text{A}$	$V_{IN} = 3V$ , $V_{EN} = 0V$
	$I_{DD}$	—	—	1600	$\mu\text{A}$	$V_{IN} = 0V$ , $V_{EN} = 0V$

**Note 1:** Tested during characterization, not production tested.

## TEMPERATURE CHARACTERISTICS

Electrical Specifications: Unless otherwise noted, all parameters apply with $4.5V \leq V_{DD} \leq 18V$ .							
Parameter	Sym.	Min.	Typ.	Max.	Units	Comments	
<b>Temperature Ranges</b>							
Specified Temperature Range	$T_A$	-40	—	+125	$^\circ\text{C}$		
Maximum Junction Temperature	$T_J$	—	—	+150	$^\circ\text{C}$		
Storage Temperature Range	$T_A$	-65	—	+150	$^\circ\text{C}$		
<b>Package Thermal Information</b>							
Junction-to-Ambient Thermal Resistance, 8LD MSOP	$\theta_{JA}$	—	158	—	$^\circ\text{C/W}$	(Note 1)	
Junction-to-Ambient Thermal Resistance, 8LD SOIC	$\theta_{JA}$	—	99.8	—	$^\circ\text{C/W}$	(Note 1)	
Junction-to-Ambient Thermal Resistance, 8LD TDFN	$\theta_{JA}$	—	53.7	—	$^\circ\text{C/W}$	(Note 1)	
Junction-to-Top Characterization Parameter, 8LD MSOP	$\Psi_{JT}$	—	2.4	—	$^\circ\text{C/W}$	(Note 1)	
Junction-to-Top Characterization Parameter, 8LD SOIC	$\Psi_{JT}$	—	5.9	—	$^\circ\text{C/W}$	(Note 1)	
Junction-to-Top Characterization Parameter, 8LD TDFN	$\Psi_{JT}$	—	0.5	—	$^\circ\text{C/W}$	(Note 1)	
Junction-to-Board Characterization Parameter, 8LD MSOP	$\Psi_{JB}$	—	115.2	—	$^\circ\text{C/W}$	(Note 1)	
Junction-to-Board Characterization Parameter, 8LD SOIC	$\Psi_{JB}$	—	64.8	—	$^\circ\text{C/W}$	(Note 1)	
Junction-to-Board Characterization Parameter, 8L TDFN	$\Psi_{JB}$	—	24.4	—	$^\circ\text{C/W}$	(Note 1)	

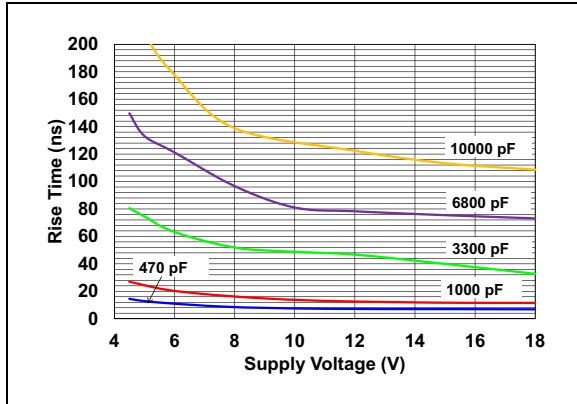
**Note 1:** Parameter is determined using a High K 2S2P 4-layer board, as described in JESD 51-7, as well as JESD 51-5 for packages with exposed pads.

# MCP14A0153/4/5

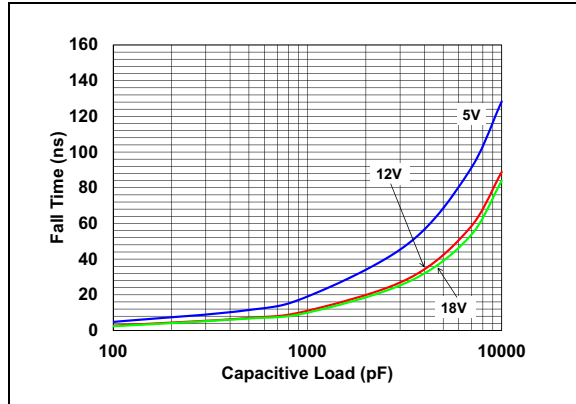
## 2.0 TYPICAL PERFORMANCE CURVES

**Note:** The graphs and tables provided following this note are a statistical summary based on a limited number of samples and are provided for informational purposes only. The performance characteristics listed herein are not tested or guaranteed. In some graphs or tables, the data presented may be outside the specified operating range (e.g., outside specified power supply range) and therefore outside the warranted range.

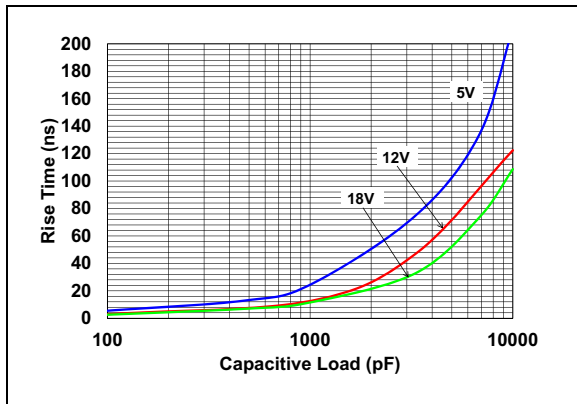
**Note:** Unless otherwise indicated,  $T_A = +25^\circ\text{C}$  with  $4.5\text{V} \leq V_{DD} \leq 18\text{V}$ .



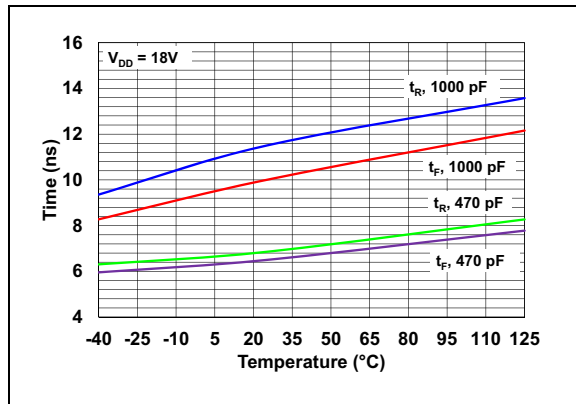
**FIGURE 2-1:** Rise Time vs. Supply Voltage.



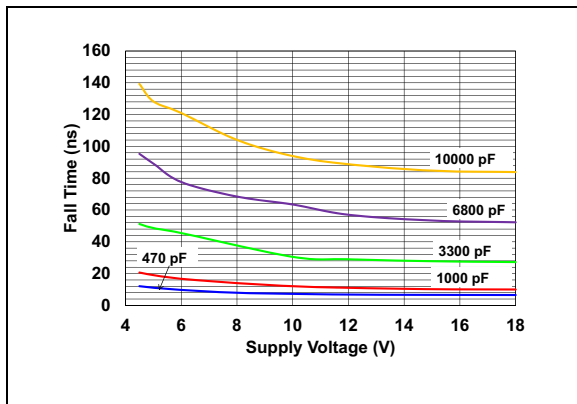
**FIGURE 2-4:** Fall Time vs. Capacitive Load.



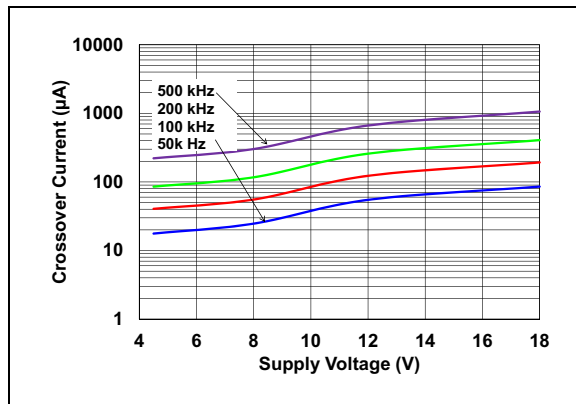
**FIGURE 2-2:** Rise Time vs. Capacitive Load.



**FIGURE 2-5:** Rise and Fall Time vs. Temperature.

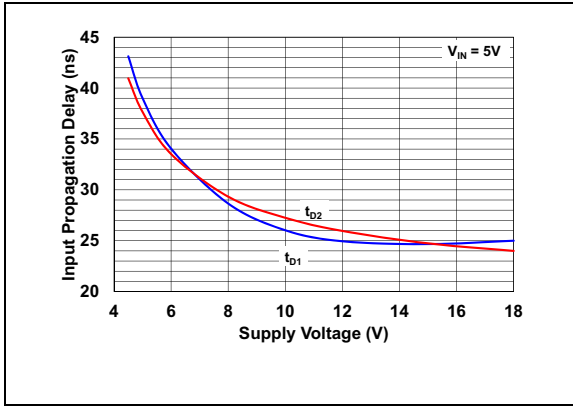


**FIGURE 2-3:** Fall Time vs. Supply Voltage.

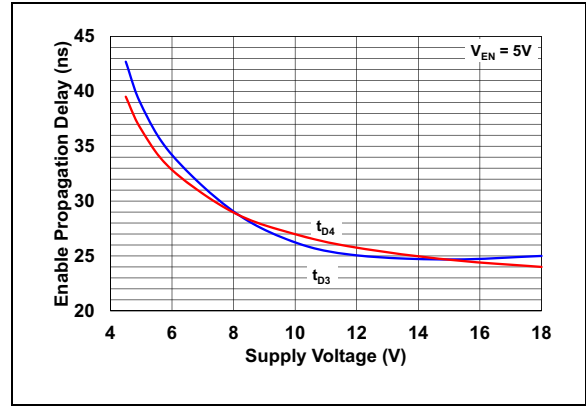


**FIGURE 2-6:** Crossover Current vs. Supply Voltage.

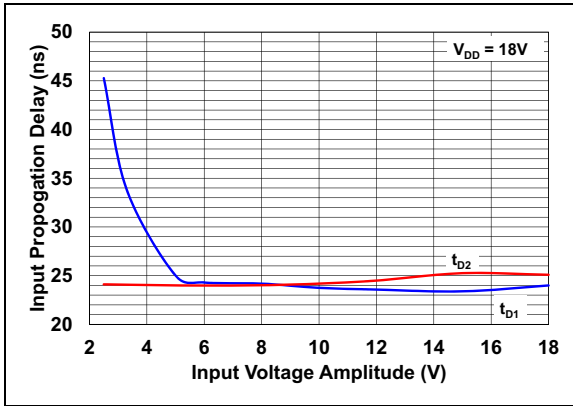
**Note:** Unless otherwise indicated,  $T_A = +25^\circ\text{C}$  with  $4.5\text{V} \leq V_{DD} \leq 18\text{V}$ .



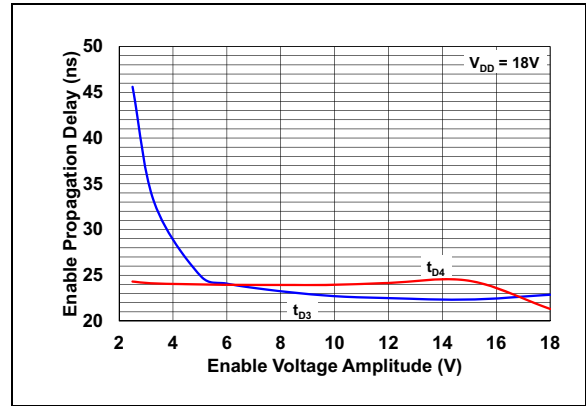
**FIGURE 2-7:** Input Propagation Delay vs. Supply Voltage.



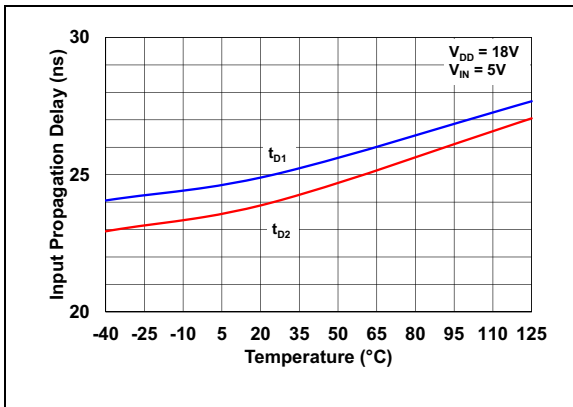
**FIGURE 2-10:** Enable Propagation Delay vs. Supply Voltage.



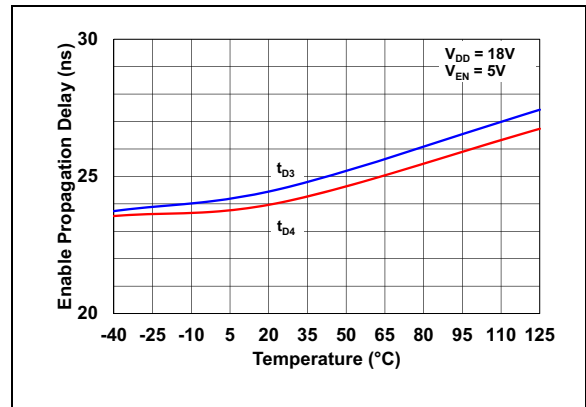
**FIGURE 2-8:** Input Propagation Delay Time vs. Input Amplitude.



**FIGURE 2-11:** Enable Propagation Delay Time vs. Enable Voltage Amplitude.



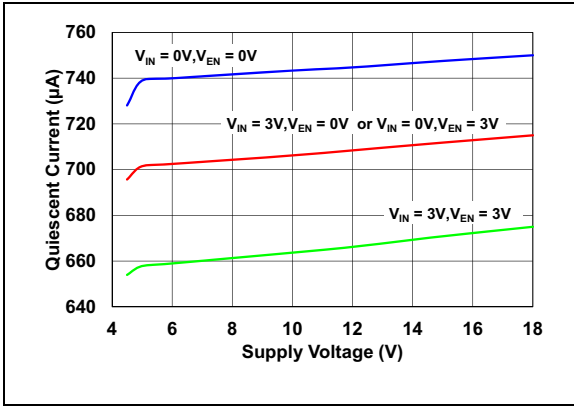
**FIGURE 2-9:** Input Propagation Delay vs. Temperature.



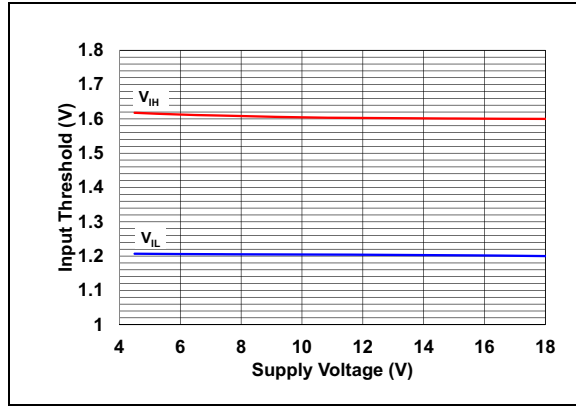
**FIGURE 2-12:** Enable Propagation Delay vs. Temperature.

# MCP14A0153/4/5

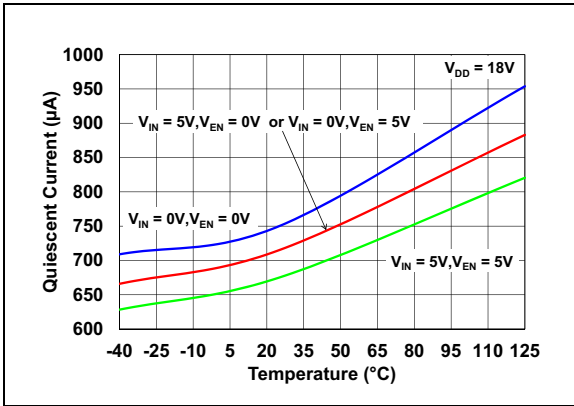
Note: Unless otherwise indicated,  $T_A = +25^\circ\text{C}$  with  $4.5\text{V} \leq V_{DD} \leq 18\text{V}$ .



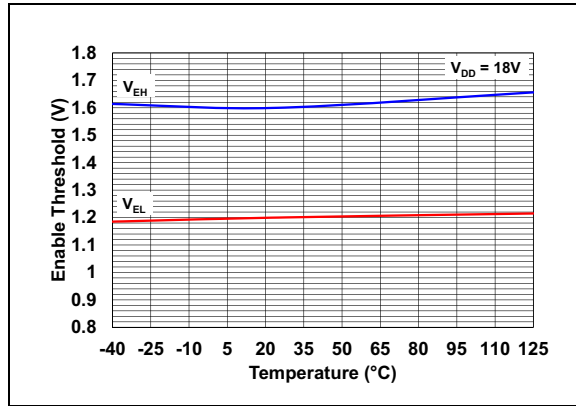
**FIGURE 2-13:** Quiescent Supply Current vs. Supply Voltage.



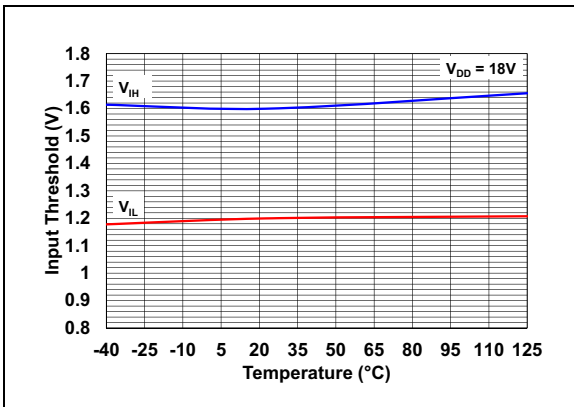
**FIGURE 2-16:** Input Threshold vs. Supply Voltage.



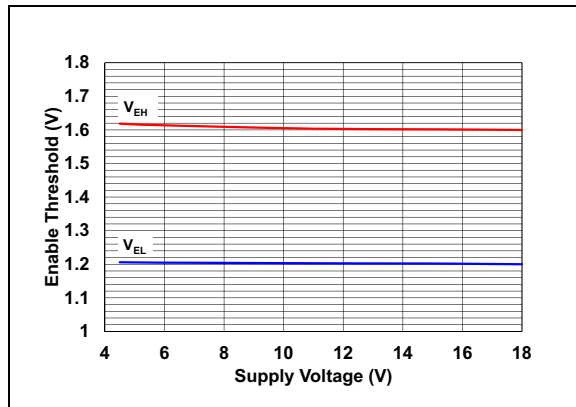
**FIGURE 2-14:** Quiescent Supply Current vs. Temperature.



**FIGURE 2-17:** Enable Threshold vs. Temperature.



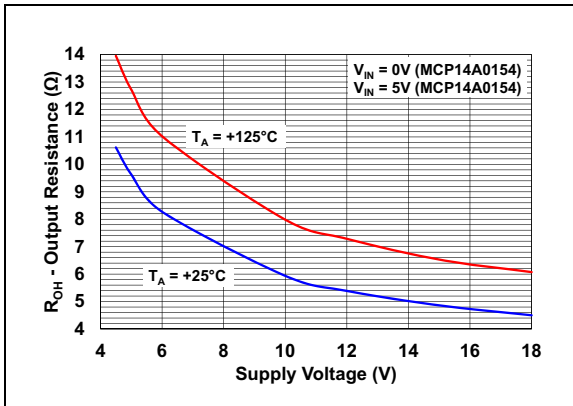
**FIGURE 2-15:** Input Threshold vs. Temperature.



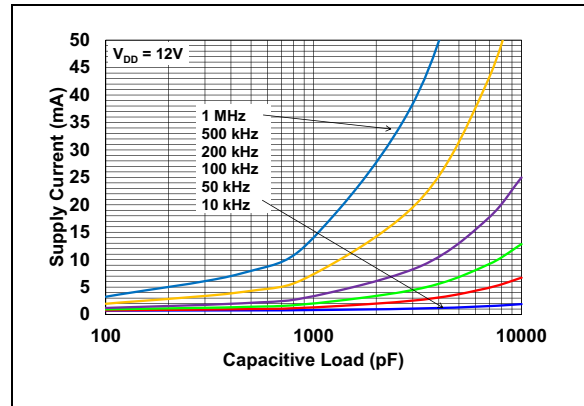
**FIGURE 2-18:** Enable Threshold vs. Supply Voltage.



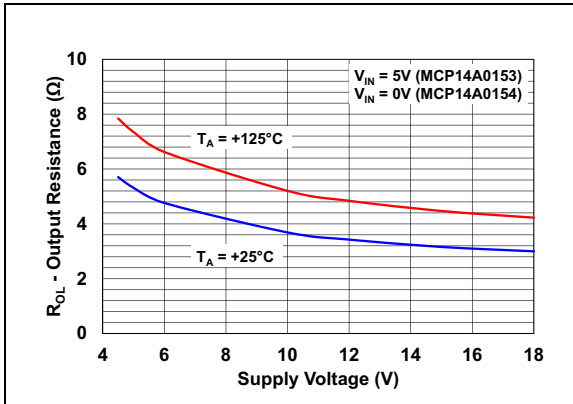
**Note:** Unless otherwise indicated,  $T_A = +25^\circ\text{C}$  with  $4.5\text{V} \leq V_{DD} \leq 18\text{V}$ .



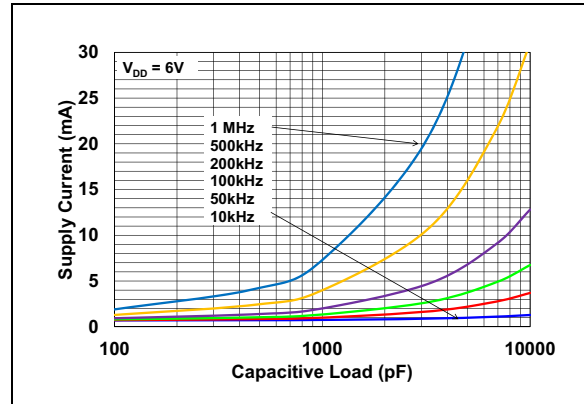
**FIGURE 2-19:** Output Resistance (Output High) vs. Supply Voltage.



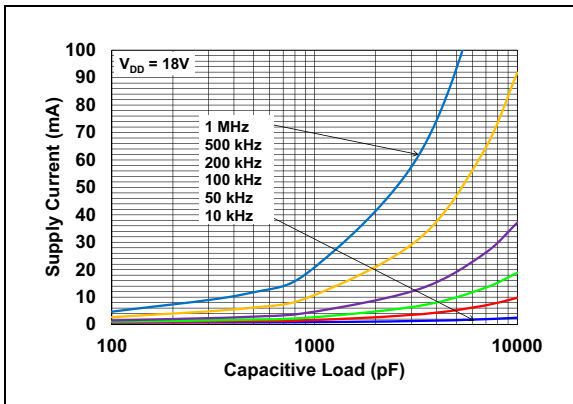
**FIGURE 2-22:** Supply Current vs. Capacitive Load ( $V_{DD} = 12\text{V}$ ).



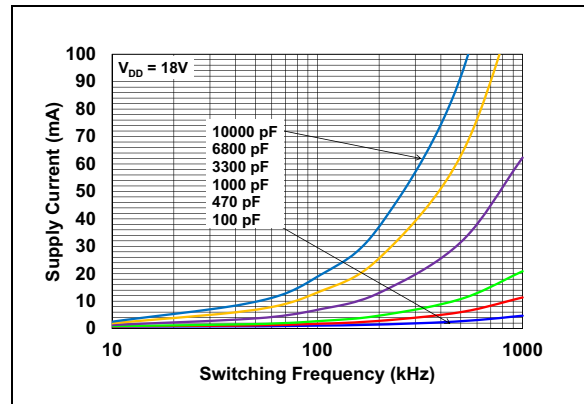
**FIGURE 2-20:** Output Resistance (Output Low) vs. Supply Voltage.



**FIGURE 2-23:** Supply Current vs. Capacitive Load ( $V_{DD} = 6\text{V}$ ).



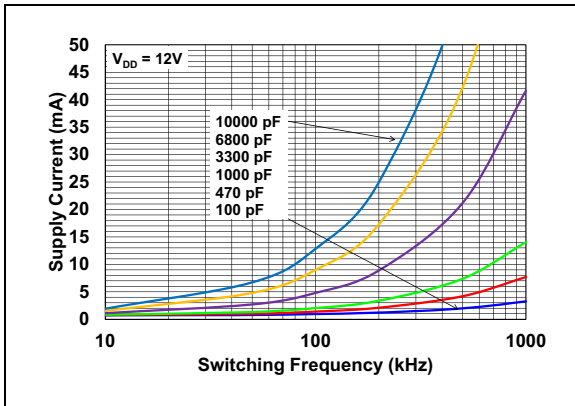
**FIGURE 2-21:** Supply Current vs. Capacitive Load ( $V_{DD} = 18\text{V}$ ).



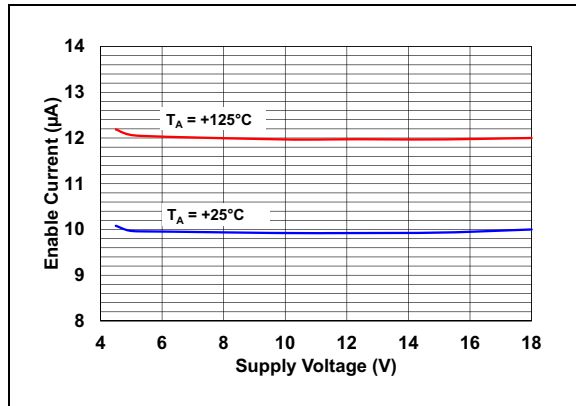
**FIGURE 2-24:** Supply Current vs. Frequency ( $V_{DD} = 18\text{V}$ ).

# MCP14A0153/4/5

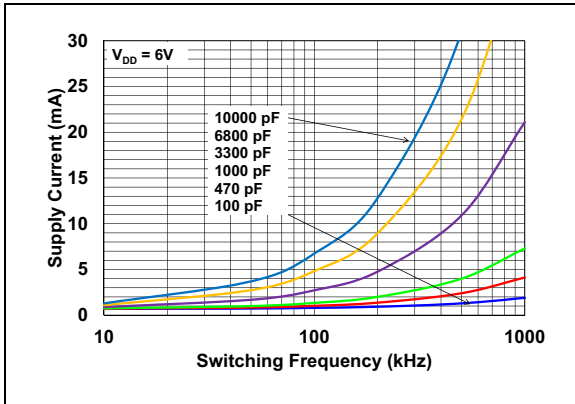
Note: Unless otherwise indicated,  $T_A = +25^\circ\text{C}$  with  $4.5\text{V} \leq V_{DD} \leq 18\text{V}$ .



**FIGURE 2-25:** Supply Current vs. Frequency ( $V_{DD} = 12\text{V}$ ).



**FIGURE 2-27:** Enable Current vs. Supply Voltage.



**FIGURE 2-26:** Supply Current vs. Frequency ( $V_{DD} = 6\text{V}$ ).

## 3.0 PIN DESCRIPTIONS

The descriptions of the pins are listed in [Table 3-1](#).

**TABLE 3-1: PIN FUNCTION TABLE**

MCP14A0153, MCP14A0154, MCP14A0155		Symbol	Description
2x3 TDFN	MSOP/SOIC		
1	1	EN A	Enable – Channel A
2	2	IN A	Input – Channel A
3	3	GND	Device Ground
4	4	IN B	Input – Channel B
5	5	$\overline{\text{OUT B}}/\text{OUT B}$	Output – Channel B
6	6	$V_{DD}$	Supply Input
7	7	$\overline{\text{OUT A}}/\text{OUT A}$	Output – Channel A
8	8	EN B	Enable – Channel B
EP	—	EP	Exposed Thermal Pad (GND)

### 3.1 Output Pins ( $\overline{\text{OUT A}}/\text{OUT A}$ , $\overline{\text{OUT B}}/\text{OUT B}$ )

The outputs are CMOS push-pull circuits that are capable of sourcing and sinking 1.5A of peak current ( $V_{DD} = 18V$ ). The low output impedance ensures the gate of the external MOSFET stays in the intended state, even during large transients. This output also has a reverse current latch-up rating of 500 mA.

### 3.2 Device Ground Pin (GND)

GND is the device return pin for the input and output stages. The GND pin should have a low-impedance connection to the bias supply source return. When the capacitive load is being discharged, high peak currents will flow through the ground pin.

### 3.3 Device Enable Pins (EN A, EN B)

The MOSFET driver device enable pins are high-impedance inputs featuring low threshold levels. The enable inputs also have hysteresis between the high and low input levels, allowing them to be driven from slow rising and falling signals, and to provide noise immunity. Driving the enable pins below the threshold will disable the corresponding output of the device, pulling  $\overline{\text{OUT}}/\text{OUT}$  low, regardless of the status of the input pin. Driving the enable pins above the threshold allows normal operation of the  $\overline{\text{OUT}}/\text{OUT}$  pin based on the status of the input pin. The enable pins utilize internal pull-up resistors, allowing the pins to be left floating for standard driver operation.

### 3.4 Control Input Pins (IN A, IN B)

The MOSFET driver control inputs are high-impedance inputs featuring low threshold levels. The inputs also have hysteresis between the high and low input levels, allowing them to be driven from slow rising and falling signals, and to provide noise immunity.

### 3.5 Supply Input Pin ( $V_{DD}$ )

$V_{DD}$  is the bias supply input for the MOSFET driver and has a voltage range of 4.5V to 18V. This input must be decoupled to ground with a local capacitor. This bypass capacitor provides a localized low-impedance path for the peak currents that are provided to the load.

### 3.6 Exposed Metal Pad Pin (EP)

The exposed metal pad of the TDFN package is internally connected to GND. Therefore, this pad should be connected to a Ground plane to aid in heat removal from the package.

# MCP14A0153/4/5

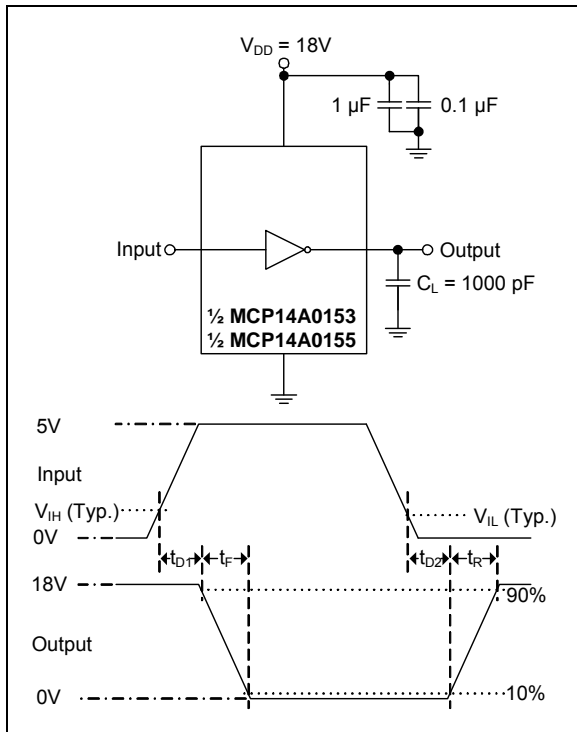
## 4.0 APPLICATION INFORMATION

### 4.1 General Information

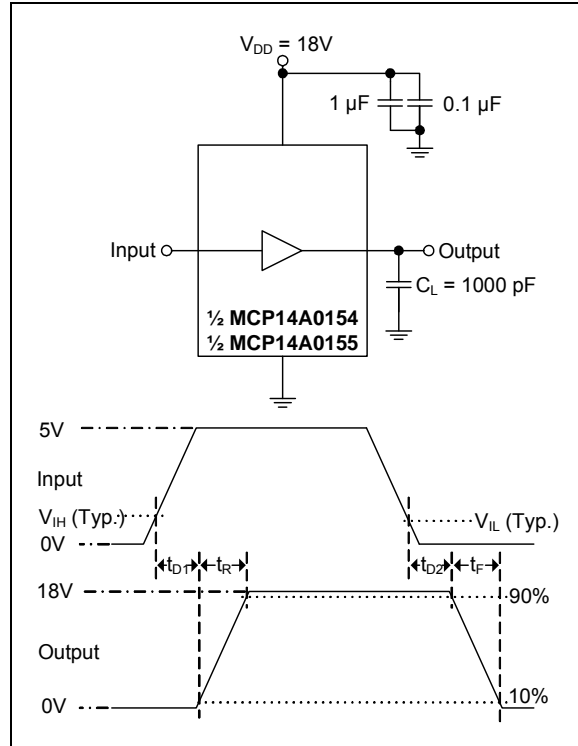
MOSFET drivers are high-speed, high-current devices which are intended to source/sink high peak currents to charge/discharge the gate capacitance of external MOSFETs or Insulated-Gate Bipolar Transistors (IGBTs). In high-frequency switching power supplies, the Pulse-Width Modulation (PWM) controller may not have the drive capability to directly drive the power MOSFET. A MOSFET driver, such as the MCP14A0153/4/5 family devices, can be used to provide additional source/sink current capability.

### 4.2 MOSFET Driver Timing

The ability of a MOSFET driver to transition from a fully OFF state to a fully ON state is characterized by the driver's rise time ( $t_R$ ), fall time ( $t_F$ ) and propagation delays ( $t_{D1}$  and  $t_{D2}$ ). Figure 4-1 and Figure 4-2 show the test circuit and timing waveform used to verify the MCP14A0153/4/5 timing.



**FIGURE 4-1:** Inverting Driver Timing Waveform.



**FIGURE 4-2:** Non-Inverting Driver Timing Waveform.

### 4.3 Enable Function

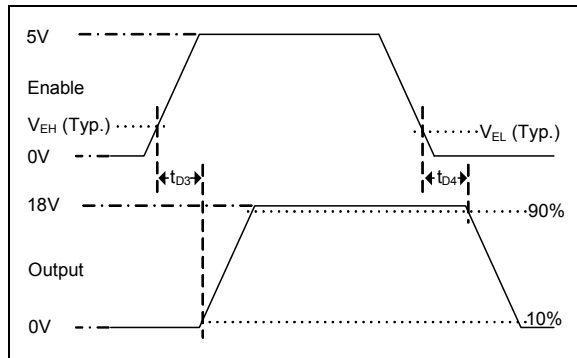
The enable pins (EN A, EN B) provide additional control of the output pins (OUT). These pins are active-high and are internally pulled up to  $V_{DD}$  so that the pins can be left floating to provide standard MOSFET driver operation.

When the enable pin input voltages are above the enable pin high-voltage threshold ( $V_{EN\_H}$ ), the corresponding output is enabled and allowed to react to the status of the input pin. However, when the voltage applied to the enable pins falls below the low threshold voltage ( $V_{EN\_L}$ ), the driver's corresponding output is disabled and doesn't respond to changes in the status of the input pins. When the driver is disabled, the output is pulled down to a low state. Refer to Table 4-1 for the enable pin logic. The threshold voltage levels for the enable pin are similar to the threshold voltage levels of the input pin and are TTL compatible. Hysteresis is provided to help increase the noise immunity of the enable function, avoiding false triggers of the enable signal during driver switching.

There are propagation delays associated with the driver receiving an enable signal and the output reacting. These propagation delays,  $t_{D3}$  and  $t_{D4}$ , are graphically represented in Figure 4-3.

**TABLE 4-1: ENABLE PIN LOGIC**

EN	IN	$\overline{\text{OUT}}$	OUT
H	H	L	H
H	L	H	L
L	X	L	L



**FIGURE 4-3: Enable Timing Waveform.**

## 4.4 Decoupling Capacitors

Careful PCB layout and decoupling capacitors are required when using power MOSFET drivers. Large current is required to charge and discharge capacitive loads quickly. For example, approximately 720 mA are needed to charge a 1000 pF load with 18V in 25 ns.

To operate the MOSFET driver over a wide frequency range with low supply impedance, it is recommended to place 1.0  $\mu\text{F}$  and 0.1  $\mu\text{F}$  low-ESR ceramic capacitors in parallel between the driver  $V_{DD}$  and GND. These capacitors should be placed close to the driver to minimize circuit board parasitics and provide a local source for the required current.

## 4.5 PCB Layout Considerations

Proper Printed Circuit Board (PCB) layout is important in high-current, fast switching circuits to provide proper device operation and robustness of design. Improper component placement may cause errant switching, excessive voltage ringing or circuit latch-up. The PCB trace loop length and inductance should be minimized by the use of ground planes or traces under the MOSFET gate drive signal. Separate analog and power grounds, and local driver decoupling should also be used.

Placing a ground plane beneath the MCP14A0153/4/5 devices will help as a radiated noise shield, as well as providing some heat sinking for power dissipated within the device.

## 4.6 Power Dissipation

The total internal power dissipation in a MOSFET driver is the summation of three separate power dissipation elements, as shown in Equation 4-1.

**EQUATION 4-1:**

$$P_T = P_L + P_Q + P_{CC}$$

Where:

- $P_T$  = Total Power Dissipation
- $P_L$  = Load Power Dissipation
- $P_Q$  = Quiescent Power Dissipation
- $P_{CC}$  = Operating Power Dissipation

### 4.6.1 CAPACITIVE LOAD DISSIPATION

The power dissipation caused by a capacitive load is a direct function of the frequency, total capacitive load and supply voltage. The power lost in the MOSFET driver for a complete charging and discharging cycle of a MOSFET is shown in Equation 4-2.

**EQUATION 4-2:**

$$P_L = f \times C_T \times V_{DD}^2$$

Where:

- $f$  = Switching Frequency
- $C_T$  = Total Load Capacitance
- $V_{DD}$  = MOSFET Driver Supply Voltage

# MCP14A0153/4/5

---

## 4.6.2 QUIESCENT POWER DISSIPATION

The power dissipation associated with the quiescent current draw depends on the state of the input and enable pins. See [Section 1.0 “Electrical Characteristics”](#) for typical quiescent current draw values in different operating states. The quiescent power dissipation is shown in [Equation 4-3](#).

### EQUATION 4-3:

$$P_Q = (I_{QH} \times D + I_{QL} \times (1 - D)) \times V_{DD}$$

Where:

$I_{QH}$  = Quiescent Current in the High State

$D$  = Duty Cycle

$I_{QL}$  = Quiescent Current in the Low State

$V_{DD}$  = MOSFET Driver Supply Voltage

## 4.6.3 OPERATING POWER DISSIPATION

The operating power dissipation occurs each time the MOSFET driver output transitions, because for a very short period of time, both MOSFETs in the output stage are on simultaneously. This crossover current leads to a power dissipation described in [Equation 4-4](#).

### EQUATION 4-4:

$$P_{CC} = V_{DD} \times I_{CO}$$

Where:

$I_{CO}$  = Crossover Current

$V_{DD}$  = MOSFET Driver Supply Voltage

## 5.0 PACKAGING INFORMATION

### 5.1 Package Marking Information

8-Lead MSOP (3x3 mm)



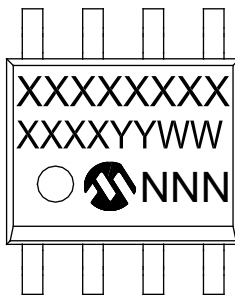
Device	Code
MCP14A0153T-E/MS	A0153
MCP14A0154T-E/MS	A0154
MCP14A0155T-E/MS	A0155

**Note:** Applies to 8-Lead MSOP.

Example



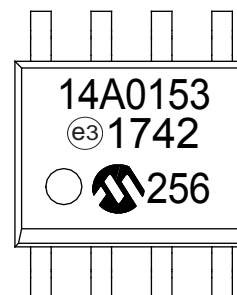
8-Lead SOIC (3.90 mm)



Device	Code
MCP14A0153T-E/SN	14A0153
MCP14A0154T-E/SN	14A0154
MCP14A0155T-E/SN	14A0155

**Note:** Applies to 8-Lead SOIC.

Example



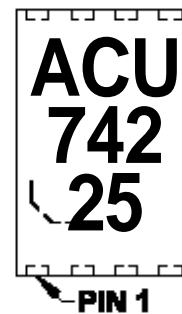
8-Lead TDFN (2x3x0.75 mm)



Device	Code
MCP14A0153T-E/MNY	ACU
MCP14A0154T-E/MNY	ACM
MCP14A0155T-E/MNY	ACV

**Note:** Applies to 8-Lead TDFN.

Example



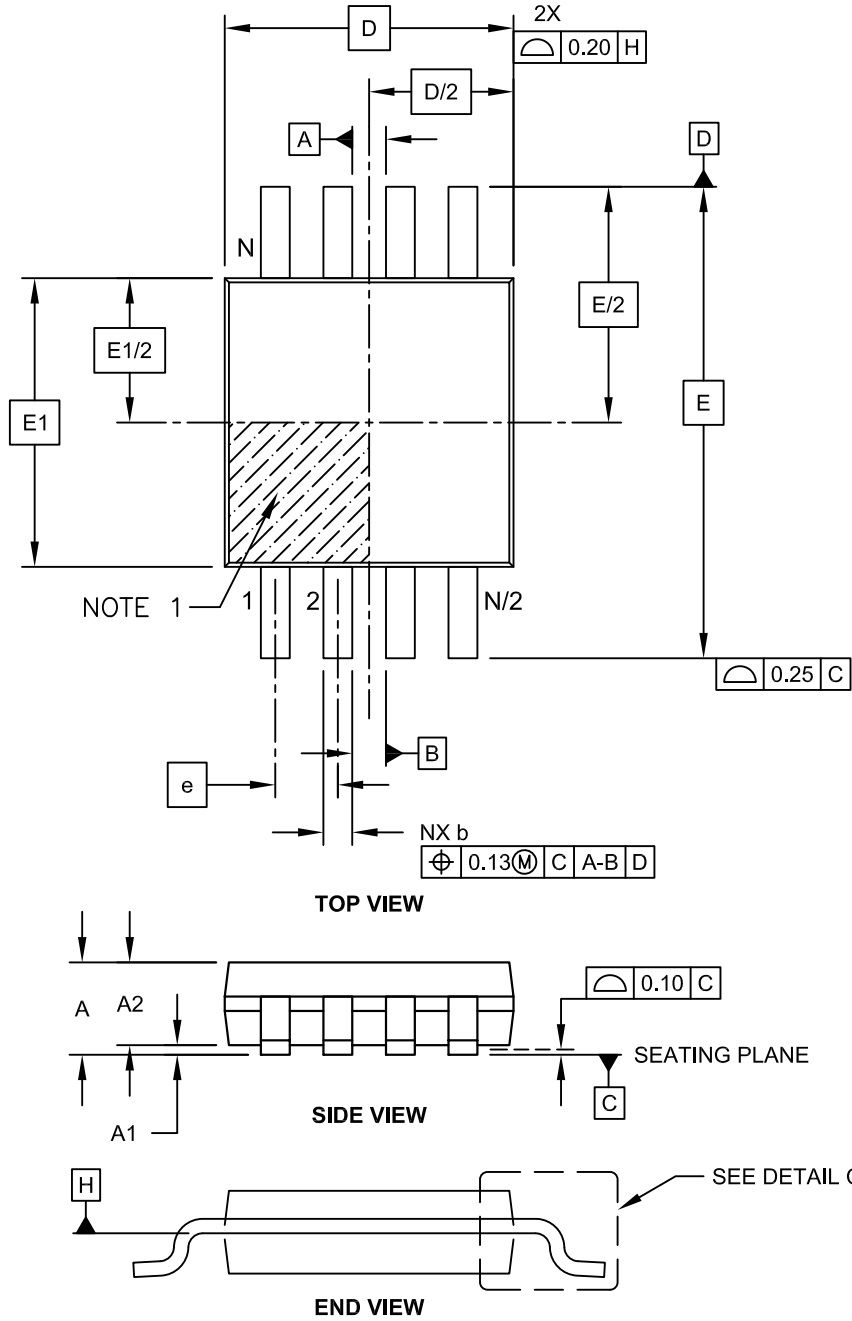
<b>Legend:</b>	XX...X	Customer-specific information
	Y	Year code (last digit of calendar year)
	YY	Year code (last 2 digits of calendar year)
	WW	Week code (week of January 1 is week '01')
	NNN	Alphanumeric traceability code
	(e3)	Pb-free JEDEC® designator for Matte Tin (Sn)
	*	This package is Pb-free. The Pb-free JEDEC designator (e3) can be found on the outer packaging for this package.

**Note:** In the event the full Microchip part number cannot be marked on one line, it will be carried over to the next line, thus limiting the number of available characters for customer-specific information.

# MCP14A0153/4/5

## 8-Lead Plastic Micro Small Outline Package (MS) [MSOP]

**Note:** For the most current package drawings, please see the Microchip Packaging Specification located at <http://www.microchip.com/packaging>

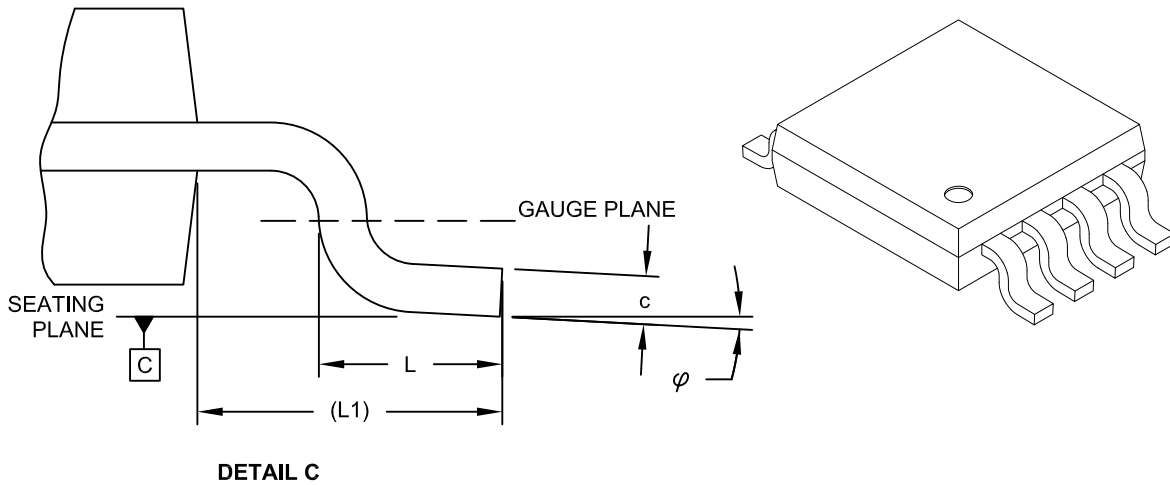


Microchip Technology Drawing C04-111C Sheet 1 of 2



## 8-Lead Plastic Micro Small Outline Package (MS) [MSOP]

**Note:** For the most current package drawings, please see the Microchip Packaging Specification located at <http://www.microchip.com/packaging>



Dimension Limits	Units	MILLIMETERS		
		MIN	NOM	MAX
Number of Pins	N		8	
Pitch	e	0.65 BSC		
Overall Height	A	-	-	1.10
Molded Package Thickness	A2	0.75	0.85	0.95
Standoff	A1	0.00	-	0.15
Overall Width	E	4.90 BSC		
Molded Package Width	E1	3.00 BSC		
Overall Length	D	3.00 BSC		
Foot Length	L	0.40	0.60	0.80
Footprint	L1	0.95 REF		
Foot Angle	$\phi$	0°	-	8°
Lead Thickness	c	0.08	-	0.23
Lead Width	b	0.22	-	0.40

**Notes:**

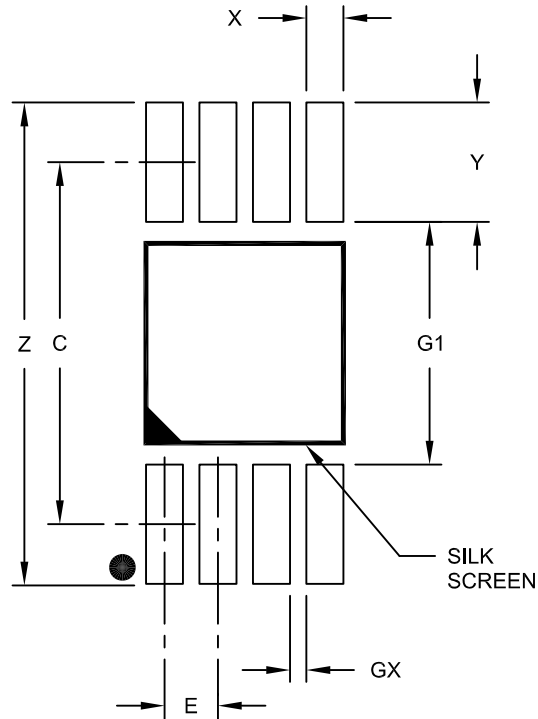
- Pin 1 visual index feature may vary, but must be located within the hatched area.
- Dimensions D and E1 do not include mold flash or protrusions. Mold flash or protrusions shall not exceed 0.15mm per side.
- Dimensioning and tolerancing per ASME Y14.5M.  
BSC: Basic Dimension. Theoretically exact value shown without tolerances.  
REF: Reference Dimension, usually without tolerance, for information purposes only.

Microchip Technology Drawing C04-111C Sheet 2 of 2

# MCP14A0153/4/5

## 8-Lead Plastic Micro Small Outline Package (MS) [MSOP]

**Note:** For the most current package drawings, please see the Microchip Packaging Specification located at <http://www.microchip.com/packaging>



RECOMMENDED LAND PATTERN

Dimension Limits	Units	MILLIMETERS		
		MIN	NOM	MAX
Contact Pitch	E	0.65 BSC		
Contact Pad Spacing	C		4.40	
Overall Width	Z			5.85
Contact Pad Width (X8)	X1			0.45
Contact Pad Length (X8)	Y1			1.45
Distance Between Pads	G1	2.95		
Distance Between Pads	GX	0.20		

**Notes:**

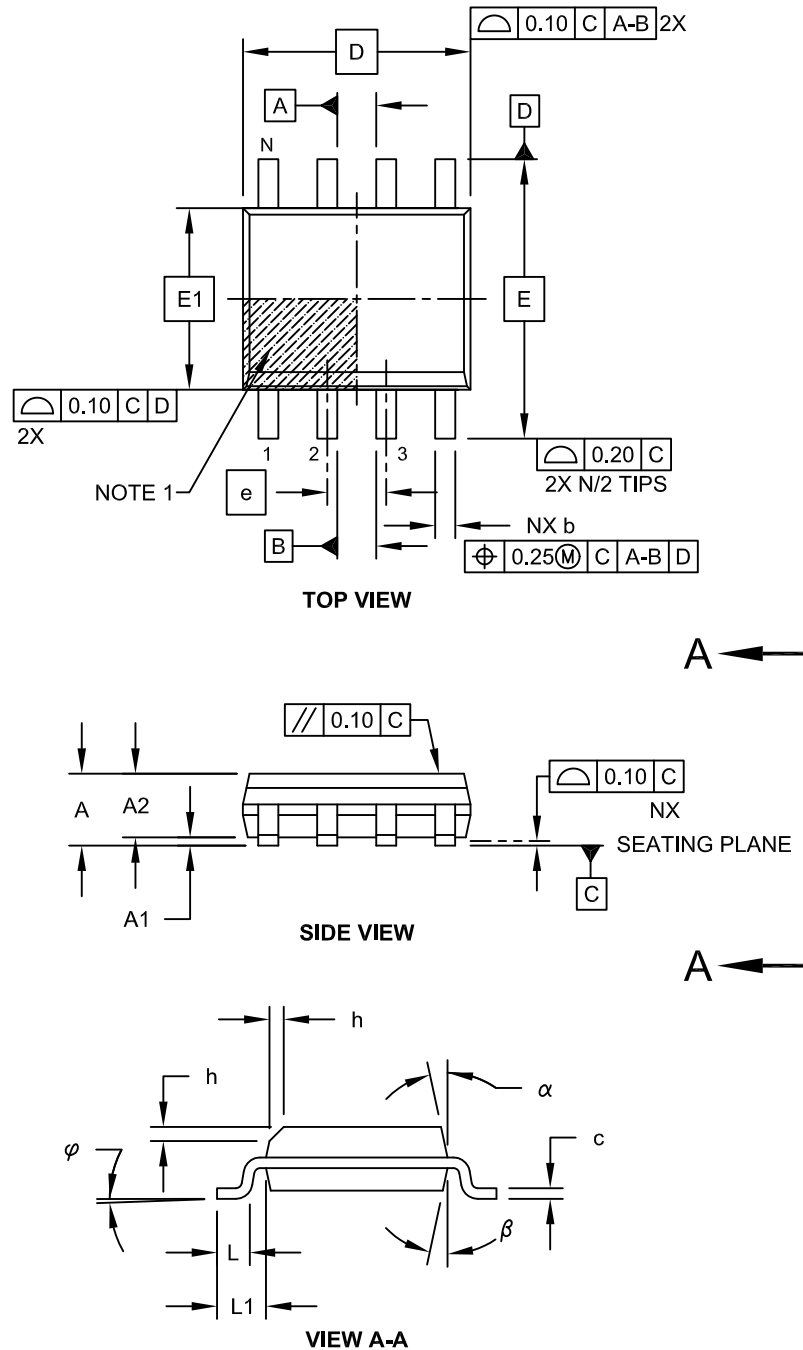
1. Dimensioning and tolerancing per ASME Y14.5M

BSC: Basic Dimension. Theoretically exact value shown without tolerances.

Microchip Technology Drawing No. C04-2111A

## 8-Lead Plastic Small Outline (SN) - Narrow, 3.90 mm Body [SOIC]

**Note:** For the most current package drawings, please see the Microchip Packaging Specification located at <http://www.microchip.com/packaging>

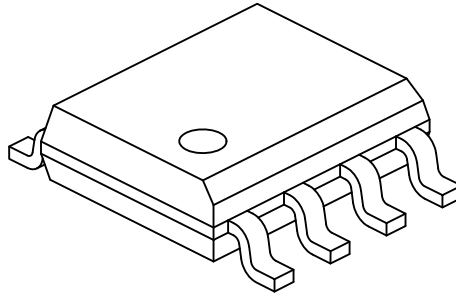


Microchip Technology Drawing No. C04-057C Sheet 1 of 2

# MCP14A0153/4/5

## 8-Lead Plastic Small Outline (SN) - Narrow, 3.90 mm Body [SOIC]

**Note:** For the most current package drawings, please see the Microchip Packaging Specification located at <http://www.microchip.com/packaging>



Dimension Limits	Units	MILLIMETERS		
		MIN	NOM	MAX
Number of Pins	N	8		
Pitch	e	1.27 BSC		
Overall Height	A	-	-	1.75
Molded Package Thickness	A2	1.25	-	-
Standoff §	A1	0.10	-	0.25
Overall Width	E	6.00 BSC		
Molded Package Width	E1	3.90 BSC		
Overall Length	D	4.90 BSC		
Chamfer (Optional)	h	0.25	-	0.50
Foot Length	L	0.40	-	1.27
Footprint	L1	1.04 REF		
Foot Angle	$\varphi$	0°	-	8°
Lead Thickness	c	0.17	-	0.25
Lead Width	b	0.31	-	0.51
Mold Draft Angle Top	$\alpha$	5°	-	15°
Mold Draft Angle Bottom	$\beta$	5°	-	15°

### Notes:

1. Pin 1 visual index feature may vary, but must be located within the hatched area.
2. § Significant Characteristic
3. Dimensions D and E1 do not include mold flash or protrusions. Mold flash or protrusions shall not exceed 0.15mm per side.
4. Dimensioning and tolerancing per ASME Y14.5M

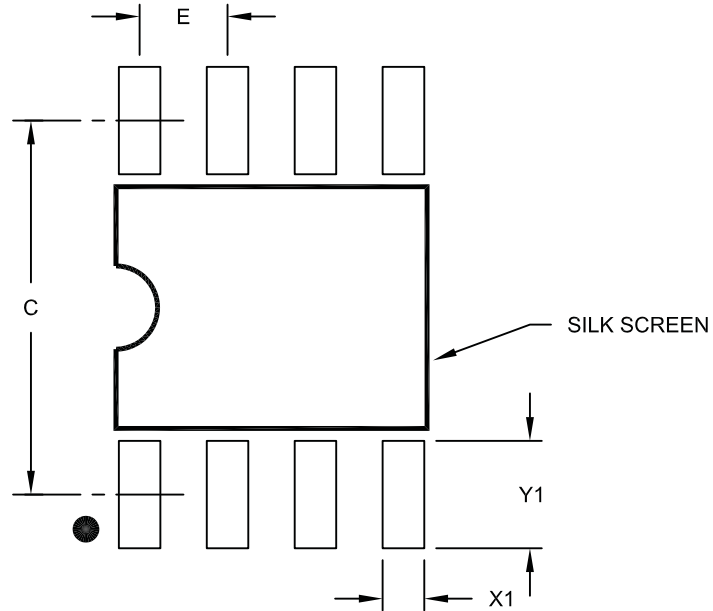
BSC: Basic Dimension. Theoretically exact value shown without tolerances.

REF: Reference Dimension, usually without tolerance, for information purposes only.

Microchip Technology Drawing No. C04-057C Sheet 2 of 2

## 8-Lead Plastic Small Outline (SN) – Narrow, 3.90 mm Body [SOIC]

**Note:** For the most current package drawings, please see the Microchip Packaging Specification located at <http://www.microchip.com/packaging>



RECOMMENDED LAND PATTERN

Dimension Limits	Units	MILLIMETERS		
		MIN	NOM	MAX
Contact Pitch	E	1.27 BSC		
Contact Pad Spacing	C		5.40	
Contact Pad Width (X8)	X1			0.60
Contact Pad Length (X8)	Y1			1.55

**Notes:**

1. Dimensioning and tolerancing per ASME Y14.5M

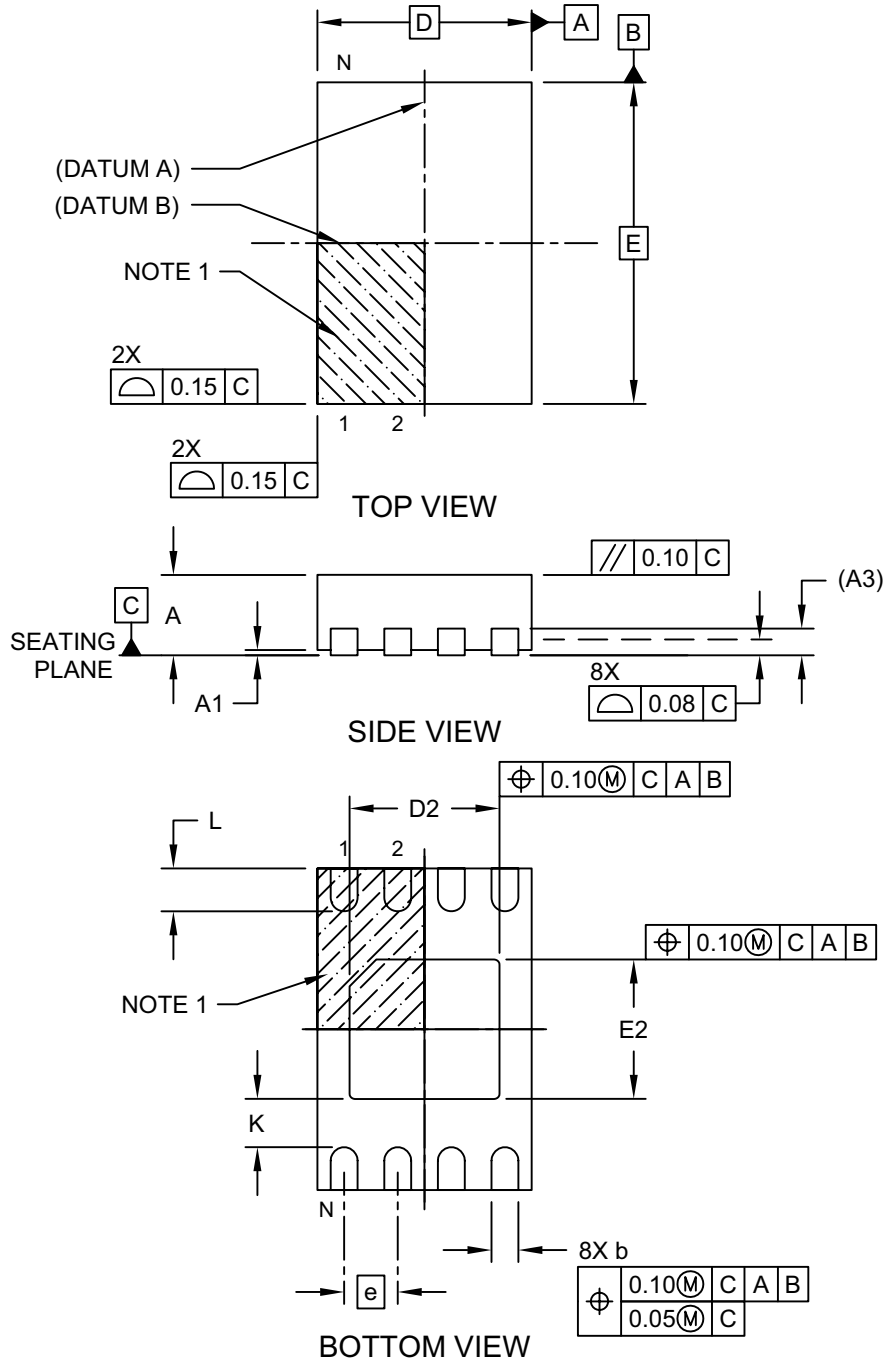
BSC: Basic Dimension. Theoretically exact value shown without tolerances.

Microchip Technology Drawing No. C04-2057A

# MCP14A0153/4/5

## 8-Lead Plastic Dual Flat, No Lead Package (MN) – 2x3x0.8 mm Body [TDFN] With 1.4x1.3 mm Exposed Pad (JEDEC Package type WDFN)

**Note:** For the most current package drawings, please see the Microchip Packaging Specification located at <http://www.microchip.com/packaging>

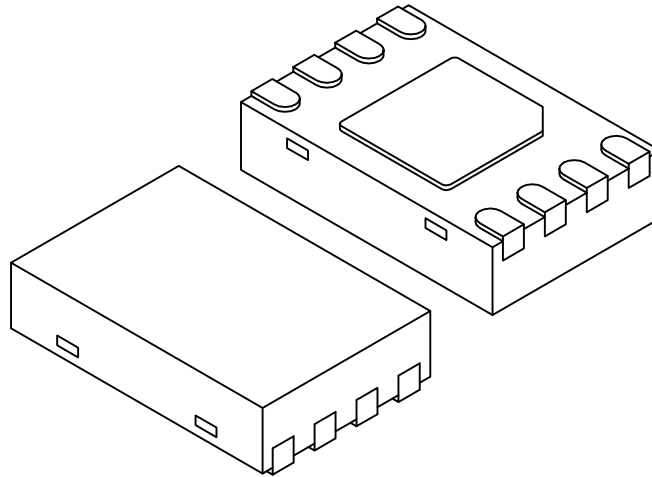


Microchip Technology Drawing No. C04-129-MN Rev E Sheet 1 of 2

# MCP14A0153/4/5

## 8-Lead Plastic Dual Flat, No Lead Package (MN) – 2x3x0.8 mm Body [TDFN] With 1.4x1.3 mm Exposed Pad (JEDEC Package type WDFN)

**Note:** For the most current package drawings, please see the Microchip Packaging Specification located at <http://www.microchip.com/packaging>



Dimension Limits	Units	MILLIMETERS		
		MIN	NOM	MAX
Number of Pins	N	8		
Pitch	e	0.50 BSC		
Overall Height	A	0.70	0.75	0.80
Standoff	A1	0.00	0.02	0.05
Contact Thickness	A3	0.20 REF		
Overall Length	D	2.00 BSC		
Overall Width	E	3.00 BSC		
Exposed Pad Length	D2	1.35	1.40	1.45
Exposed Pad Width	E2	1.25	1.30	1.35
Contact Width	b	0.20	0.25	0.30
Contact Length	L	0.25	0.30	0.45
Contact-to-Exposed Pad	K	0.20	-	-

### Notes:

1. Pin 1 visual index feature may vary, but must be located within the hatched area.
2. Package may have one or more exposed tie bars at ends.
3. Package is saw singulated
4. Dimensioning and tolerancing per ASME Y14.5M

BSC: Basic Dimension. Theoretically exact value shown without tolerances.

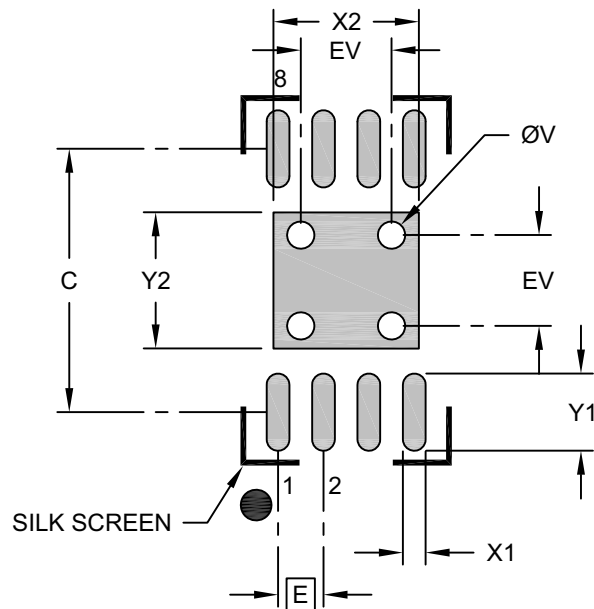
REF: Reference Dimension, usually without tolerance, for information purposes only.

Microchip Technology Drawing No. C04-129-MN Rev E Sheet 2 of 2

# MCP14A0153/4/5

## 8-Lead Plastic Dual Flat, No Lead Package (MN) – 2x3x0.8 mm Body [TDFN] With 1.4x1.3 mm Exposed Pad (JEDEC Package type WDFN)

**Note:** For the most current package drawings, please see the Microchip Packaging Specification located at <http://www.microchip.com/packageing>



RECOMMENDED LAND PATTERN

Dimension Limits	Units	MILLIMETERS		
		MIN	NOM	MAX
Contact Pitch	E	0.50 BSC		
Optional Center Pad Width	X2			1.60
Optional Center Pad Length	Y2			1.50
Contact Pad Spacing	C		2.90	
Contact Pad Width (X8)	X1			0.25
Contact Pad Length (X8)	Y1			0.85
Thermal Via Diameter	V		0.30	
Thermal Via Pitch	EV		1.00	

Notes:

- Dimensioning and tolerancing per ASME Y14.5M  
BSC: Basic Dimension. Theoretically exact value shown without tolerances.
- For best soldering results, thermal vias, if used, should be filled or tented to avoid solder loss during reflow process

Microchip Technology Drawing No. C04-129-MN Rev. B



## APPENDIX A: REVISION HISTORY

### Revision B (July 2017)

The following is the list of modifications:

- Updated the [Typical Performance Curves](#).
- Updated the [Packaging Information](#).
- Various typographical edits.

### Revision A (December 2015)

- Original release of this document

# MCP14A0153/4/5

---

NOTES:

## PRODUCT IDENTIFICATION SYSTEM

To order or obtain information, e.g., on pricing or delivery, refer to the factory or the listed sales office.

<u>PART NO.</u>	<u>X1<sup>(1)</sup></u>	<u>-X</u>	<u>/XX</u>
Device	Tape and Reel	Temperature Range	Package
<p><b>Device:</b></p> <p>MCP14A0153: High-Speed MOSFET Driver</p> <p>MCP14A0154: High-Speed MOSFET Driver</p> <p>MCP14A0155: High-Speed MOSFET Driver</p> <p>MCP14A0153T: High-Speed MOSFET Driver (Tape and Reel)</p> <p>MCP14A0154T: High-Speed MOSFET Driver (Tape and Reel)</p> <p>MCP14A0155T: High-Speed MOSFET Driver (Tape and Reel)</p>			
<p><b>Temperature Range:</b> E = -40°C to +125°C (Extended)</p>			
<p><b>Package:</b></p> <p>MS = 8-Lead Plastic Micro Small Outline Package (MSOP)</p> <p>SN = 8-Lead Plastic Small Outline Package (SOIC)</p> <p>MNY* = 8-Lead Plastic Dual Flat, No Lead Package - 2x3x0.8 mm Body (TDFN)</p> <p>*Y = Nickel Palladium Gold Manufacturing Designator. Only available on the TDFN package.</p>			
<p><b>Examples:</b></p> <p>a) MCP14A0153T-E/MS: Tape and Reel, Extended Temperature, 8-Lead MSOP Package</p> <p>b) MCP14A0153-E/MS: Extended Temperature, 8-Lead MSOP Package</p> <p>c) MCP14A0154T-E/SN: Tape and Reel, Extended Temperature, 8-Lead SOIC Package</p> <p>d) MCP14A0154-E/SN: Extended Temperature, 8-Lead SOIC Package</p> <p>e) MCP14A0155T-E/MNY: Tape and Reel, Extended Temperature, 8-Lead TDFN Package</p>			
<p><b>Note 1:</b> Tape and Reel identifier only appears in the catalog part number description. This identifier is used for ordering purposes and is not printed on the device package. Check with your Microchip Sales Office for package availability with the Tape and Reel option.</p>			

# MCP14A0153/4/5

---

NOTES:

---

**Note the following details of the code protection feature on Microchip devices:**

- Microchip products meet the specification contained in their particular Microchip Data Sheet.
- Microchip believes that its family of products is one of the most secure families of its kind on the market today, when used in the intended manner and under normal conditions.
- There are dishonest and possibly illegal methods used to breach the code protection feature. All of these methods, to our knowledge, require using the Microchip products in a manner outside the operating specifications contained in Microchip's Data Sheets. Most likely, the person doing so is engaged in theft of intellectual property.
- Microchip is willing to work with the customer who is concerned about the integrity of their code.
- Neither Microchip nor any other semiconductor manufacturer can guarantee the security of their code. Code protection does not mean that we are guaranteeing the product as “unbreakable.”

Code protection is constantly evolving. We at Microchip are committed to continuously improving the code protection features of our products. Attempts to break Microchip's code protection feature may be a violation of the Digital Millennium Copyright Act. If such acts allow unauthorized access to your software or other copyrighted work, you may have a right to sue for relief under that Act.

---

Information contained in this publication regarding device applications and the like is provided only for your convenience and may be superseded by updates. It is your responsibility to ensure that your application meets with your specifications. MICROCHIP MAKES NO REPRESENTATIONS OR WARRANTIES OF ANY KIND WHETHER EXPRESS OR IMPLIED, WRITTEN OR ORAL, STATUTORY OR OTHERWISE, RELATED TO THE INFORMATION, INCLUDING BUT NOT LIMITED TO ITS CONDITION, QUALITY, PERFORMANCE, MERCHANTABILITY OR FITNESS FOR PURPOSE. Microchip disclaims all liability arising from this information and its use. Use of Microchip devices in life support and/or safety applications is entirely at the buyer's risk, and the buyer agrees to defend, indemnify and hold harmless Microchip from any and all damages, claims, suits, or expenses resulting from such use. No licenses are conveyed, implicitly or otherwise, under any Microchip intellectual property rights unless otherwise stated.

*Microchip received ISO/TS-16949:2009 certification for its worldwide headquarters, design and wafer fabrication facilities in Chandler and Tempe, Arizona; Gresham, Oregon and design centers in California and India. The Company's quality system processes and procedures are for its PIC® MCUs and dsPIC® DSCs, KEELoQ® code hopping devices, Serial EEPROMs, microperipherals, nonvolatile memory and analog products. In addition, Microchip's quality system for the design and manufacture of development systems is ISO 9001:2000 certified.*

**QUALITY MANAGEMENT SYSTEM  
CERTIFIED BY DNV  
= ISO/TS 16949 =**

**Trademarks**

The Microchip name and logo, the Microchip logo, AnyRate, AVR, AVR logo, AVR Freaks, BeaconThings, BitCloud, CryptoMemory, CryptoRF, dsPIC, FlashFlex, flexPWR, Heldo, JukeBlox, KEELoQ, KEELoQ logo, Klear, LANCheck, LINK MD, maXStylus, maXTouch, MediaLB, megaAVR, MOST, MOST logo, MPLAB, OptoLyzer, PIC, picoPower, PICSTART, PIC32 logo, Prochip Designer, QTouch, RightTouch, SAM-BA, SpyNIC, SST, SST Logo, SuperFlash, tinyAVR, UNI/O, and XMEGA are registered trademarks of Microchip Technology Incorporated in the U.S.A. and other countries.

ClockWorks, The Embedded Control Solutions Company, EtherSynch, Hyper Speed Control, HyperLight Load, IntelliMOS, mTouch, Precision Edge, and Quiet-Wire are registered trademarks of Microchip Technology Incorporated in the U.S.A.

Adjacent Key Suppression, AKS, Analog-for-the-Digital Age, Any Capacitor, AnyIn, AnyOut, BodyCom, chipKIT, chipKIT logo, CodeGuard, CryptoAuthentication, CryptoCompanion, CryptoController, dsPICDEM, dsPICDEM.net, Dynamic Average Matching, DAM, ECAN, EtherGREEN, In-Circuit Serial Programming, ICSP, Inter-Chip Connectivity, JitterBlocker, KlearNet, KlearNet logo, Mindi, MiWi, motorBench, MPASM, MPF, MPLAB Certified logo, MPLIB, MPLINK, MultiTRAK, NetDetach, Omniscient Code Generation, PICDEM, PICDEM.net, PICKit, PICtail, PureSilicon, QMatrix, RightTouch logo, REAL ICE, Ripple Blocker, SAM-ICE, Serial Quad I/O, SMART-I.S., SQI, SuperSwitcher, SuperSwitcher II, Total Endurance, TSHARC, USBCheck, VariSense, ViewSpan, WiperLock, Wireless DNA, and ZENA are trademarks of Microchip Technology Incorporated in the U.S.A. and other countries.

SQTP is a service mark of Microchip Technology Incorporated in the U.S.A.

Silicon Storage Technology is a registered trademark of Microchip Technology Inc. in other countries.

GestIC is a registered trademark of Microchip Technology Germany II GmbH & Co. KG, a subsidiary of Microchip Technology Inc., in other countries.

All other trademarks mentioned herein are property of their respective companies.

© 2015-2017, Microchip Technology Incorporated, All Rights Reserved.

ISBN: 978-1-5224-1930-3



# MICROCHIP

## Worldwide Sales and Service

### AMERICAS

**Corporate Office**  
2355 West Chandler Blvd.  
Chandler, AZ 85224-6199  
Tel: 480-792-7200  
Fax: 480-792-7277  
Technical Support:  
<http://www.microchip.com/support>  
Web Address:  
[www.microchip.com](http://www.microchip.com)

**Atlanta**  
Duluth, GA  
Tel: 678-957-9614  
Fax: 678-957-1455

**Austin, TX**  
Tel: 512-257-3370

**Boston**  
Westborough, MA  
Tel: 774-760-0087  
Fax: 774-760-0088

**Chicago**  
Itasca, IL  
Tel: 630-285-0071  
Fax: 630-285-0075

**Dallas**  
Addison, TX  
Tel: 972-818-7423  
Fax: 972-818-2924

**Detroit**  
Novi, MI  
Tel: 248-848-4000

**Houston, TX**  
Tel: 281-894-5983

**Indianapolis**  
Noblesville, IN  
Tel: 317-773-8323  
Fax: 317-773-5453  
Tel: 317-536-2380

**Los Angeles**  
Mission Viejo, CA  
Tel: 949-462-9523  
Fax: 949-462-9608  
Tel: 951-273-7800

**Raleigh, NC**  
Tel: 919-844-7510

**New York, NY**  
Tel: 631-435-6000

**San Jose, CA**  
Tel: 408-735-9110  
Tel: 408-436-4270

**Canada - Toronto**  
Tel: 905-695-1980  
Fax: 905-695-2078

### ASIA/PACIFIC

**Asia Pacific Office**  
Suites 3707-14, 37th Floor  
Tower 6, The Gateway  
Harbour City, Kowloon

**Hong Kong**  
Tel: 852-2943-5100  
Fax: 852-2401-3431

**Australia - Sydney**  
Tel: 61-2-9868-6733  
Fax: 61-2-9868-6755

**China - Beijing**  
Tel: 86-10-8569-7000  
Fax: 86-10-8528-2104

**China - Chengdu**  
Tel: 86-28-8665-5511  
Fax: 86-28-8665-7889

**China - Chongqing**  
Tel: 86-23-8980-9588  
Fax: 86-23-8980-9500

**China - Dongguan**  
Tel: 86-769-8702-9880

**China - Guangzhou**  
Tel: 86-20-8755-8029

**China - Hangzhou**  
Tel: 86-571-8792-8115  
Fax: 86-571-8792-8116

**China - Hong Kong SAR**  
Tel: 852-2943-5100  
Fax: 852-2401-3431

**China - Nanjing**  
Tel: 86-25-8473-2460  
Fax: 86-25-8473-2470

**China - Qingdao**  
Tel: 86-532-8502-7355  
Fax: 86-532-8502-7205

**China - Shanghai**  
Tel: 86-21-3326-8000  
Fax: 86-21-3326-8021

**China - Shenyang**  
Tel: 86-24-2334-2829  
Fax: 86-24-2334-2393

**China - Shenzhen**  
Tel: 86-755-8864-2200  
Fax: 86-755-8203-1760

**China - Wuhan**  
Tel: 86-27-5980-5300  
Fax: 86-27-5980-5118

**China - Xian**  
Tel: 86-29-8833-7252  
Fax: 86-29-8833-7256

### ASIA/PACIFIC

**China - Xiamen**  
Tel: 86-592-2388138  
Fax: 86-592-2388130

**China - Zhuhai**  
Tel: 86-756-3210040  
Fax: 86-756-3210049

**India - Bangalore**  
Tel: 91-80-3090-4444  
Fax: 91-80-3090-4123

**India - New Delhi**  
Tel: 91-11-4160-8631  
Fax: 91-11-4160-8632

**India - Pune**  
Tel: 91-20-3019-1500

**Japan - Osaka**  
Tel: 81-6-6152-7160  
Fax: 81-6-6152-9310

**Japan - Tokyo**  
Tel: 81-3-6880-3770  
Fax: 81-3-6880-3771

**Korea - Daegu**  
Tel: 82-53-744-4301  
Fax: 82-53-744-4302

**Korea - Seoul**  
Tel: 82-2-554-7200  
Fax: 82-2-558-5932 or  
82-2-558-5934

**Malaysia - Kuala Lumpur**  
Tel: 60-3-6201-9857  
Fax: 60-3-6201-9859

**Malaysia - Penang**  
Tel: 60-4-227-8870  
Fax: 60-4-227-4068

**Philippines - Manila**  
Tel: 63-2-634-9065  
Fax: 63-2-634-9069

**Singapore**  
Tel: 65-6334-8870  
Fax: 65-6334-8850

**Taiwan - Hsin Chu**  
Tel: 886-3-5778-366  
Fax: 886-3-5770-955

**Taiwan - Kaohsiung**  
Tel: 886-7-213-7830

**Taiwan - Taipei**  
Tel: 886-2-2508-8600  
Fax: 886-2-2508-0102

**Thailand - Bangkok**  
Tel: 66-2-694-1351  
Fax: 66-2-694-1350

### EUROPE

**Austria - Wels**  
Tel: 43-7242-2244-39  
Fax: 43-7242-2244-393

**Denmark - Copenhagen**  
Tel: 45-4450-2828  
Fax: 45-4485-2829

**Finland - Espoo**  
Tel: 358-9-4520-820

**France - Paris**  
Tel: 33-1-69-53-63-20  
Fax: 33-1-69-30-90-79

**France - Saint Cloud**  
Tel: 33-1-30-60-70-00

**Germany - Garching**  
Tel: 49-8931-9700

**Germany - Haan**  
Tel: 49-2129-3766400

**Germany - Heilbronn**  
Tel: 49-7131-67-3636

**Germany - Karlsruhe**  
Tel: 49-721-625370

**Germany - Munich**  
Tel: 49-89-627-144-0  
Fax: 49-89-627-144-44

**Germany - Rosenheim**  
Tel: 49-8031-354-560

**Israel - Ra'anana**  
Tel: 972-9-744-7705

**Italy - Milan**  
Tel: 39-0331-742611  
Fax: 39-0331-466781

**Italy - Padova**  
Tel: 39-049-7625286

**Netherlands - Drunen**  
Tel: 31-416-690399  
Fax: 31-416-690340

**Norway - Trondheim**  
Tel: 47-7289-7561

**Poland - Warsaw**  
Tel: 48-22-3325737

**Romania - Bucharest**  
Tel: 40-21-407-87-50

**Spain - Madrid**  
Tel: 34-91-708-08-90  
Fax: 34-91-708-08-91

**Sweden - Gothenberg**  
Tel: 46-31-704-60-40

**Sweden - Stockholm**  
Tel: 46-8-5090-4654

**UK - Wokingham**  
Tel: 44-118-921-5800  
Fax: 44-118-921-5820