

USB Dual-Port Power Switch and Current Monitor

Features

- Dual-Port Power Switches:
 - 2.9V to 5.5V source voltage range
 - 3.0A continuous current per V_{BUS} port with 18 m Ω On resistance per switch
 - Independent port power switch enable pins
 - DUAL fault ALERT# active drain output pins
 - Constant Current or Trip mode current limiting behaviors
 - Undervoltage and overvoltage lockout
 - Back-drive, back-voltage protection
 - Auto-recovery fault handling with low test current
 - BOOST# logic output to increase DC-DC converter output under large load conditions
- SMBus 2.0/I²C Mode Features:
 - Eight programmable current limits assignable to each power switch
 - Other SMBus addresses available upon request
 - Block read and block write
- Self-Contained Current Monitoring (No External Sense Resistor Required)
- Fully Programmable Per-Port Charge Rationing and Behaviors
- Configurable Per-Port BC1.2 V_{BUS} Discharge Function
- Wide Operating Temperature Range:
 - -40°C to +105°C

Description

The UCS2114 is a dual USB port power switch configuration that can provide 3.0A continuous current (3.4A maximum) per V_{BUS} port with precision overcurrent limiting (OCL), port power switch enables, auto-recovery fault handling, undervoltage and overvoltage lockout, back-drive and back-voltage protection, and thermal protection.

The UCS2114 is well-suited for both stand-alone and applications having SMBus/I²C communications.

For applications with SMBus, the UCS2114 provides per-port current monitoring and eight programmable current limits per switch, ranging from 0.53A to 3.0A continuous current (3.4A maximum). Per-port charge rationing is also provided, ranging from 3.8 mAh to 246.3 Ah.

In Stand-Alone mode, the UCS2114 provides eight current limits for both switches, ranging from 0.53A + 0.53A to 3A + 3A total continuous current (see [Table 1-1](#)).

Both power switches include an independent V_{BUS} discharge function and Constant Current mode limiting for BC1.2 applications.

The UCS2114 is available in a 3x3 mm 20-pin VQFN package.

Package Type

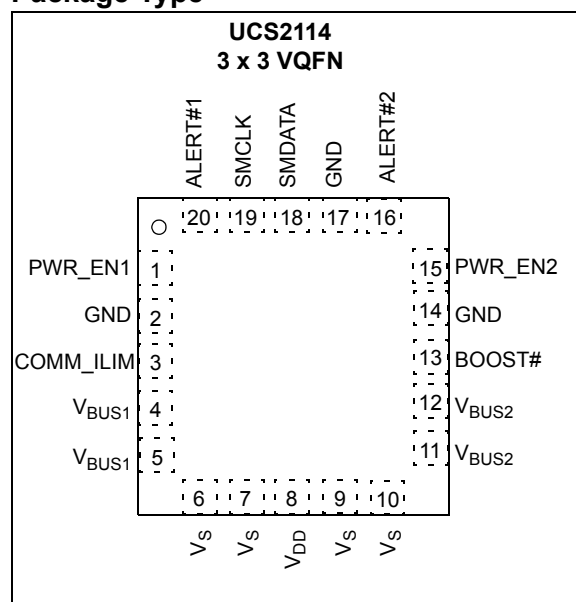

UCS2114

Block Diagram

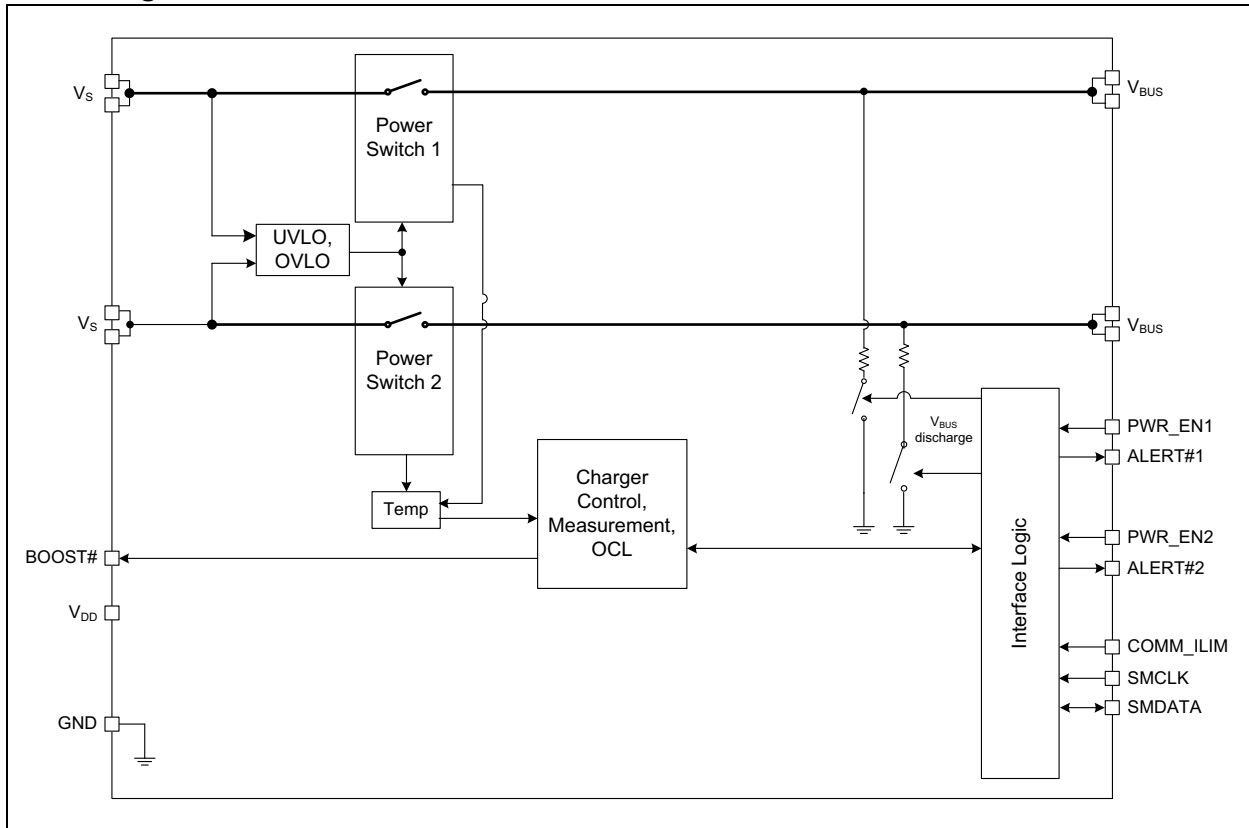

1.0 ELECTRICAL CHARACTERISTICS

Absolute Maximum Ratings †

| | |
|--|-------------------------|
| Voltage on V_{DD} , V_S and V_{BUS} pins | -0.3 to 6V |
| Pull-Up Voltage (V_{PULLUP}) | -0.3 to $V_{DD} + 0.3$ |
| Port Power Switch Current | Internally limited |
| Voltage on any Other Pin to Ground | -0.3 to $V_{DD} + 0.3V$ |
| Current on any Other Pin | ± 10 mA |
| Operating Ambient Temperature Range | -40°C to +105°C |
| Storage Temperature Range | -55°C to +150°C |

† **Notice:** Stresses above those listed under “Maximum Ratings” may cause permanent damage to the device. This is a stress rating only and functional operation of the device at those or any other conditions above those indicated in the operation listings of this specification is not implied. Exposure to maximum rating conditions for extended periods may affect device reliability.

TABLE 1-1: ELECTRICAL SPECIFICATIONS

| Electrical Characteristics: Unless otherwise specified, $V_{DD} = 4.5V$ to $5.5V$, $V_S = 2.9V$ to $5.5V$, $V_{PULLUP} = 3V$ to $5.5V$, $T_A = -40^\circ C$ to $105^\circ C$. All typical values at $V_{DD} = V_S = 5V$, $T_A = 27^\circ C$. | | | | | | |
|--|--------------------|------|------|------|---------|---|
| Characteristic | Symbol | Min. | Typ. | Max. | Unit | Conditions |
| Power and Interrupts - DC | | | | | | |
| Supply Voltage | V_{DD} | 4.5 | 5 | 5.5 | V | |
| Supply Current in Active ($I_{DD_ACT} + I_{S1_ACT} + I_{S2_ACT}$) | I_{ACTIVE} | — | 700 | — | μA | Average current $I_{BUS} = 0$ mA |
| Supply Current in Sleep ($I_{DD_SLEEP} + I_{S1_SLEEP} + I_{S2_SLEEP}$) | I_{SLEEP} | — | 6 | 20 | μA | Average current $V_{PULLUP} \leq V_{DD}$ |
| Power-on Reset | | | | | | |
| V_{DD} Low Threshold | V_{DD_TH} | — | 4 | 4.3 | V | V_{DD} voltage increasing (Note 1) |
| V_{DD} Low Hysteresis | $V_{DD_TH_HYST}$ | — | 500 | 600 | mV | V_{DD} voltage decreasing (Note 1) |

- Note 1:** This parameter is characterized, not 100% tested.
Note 2: This parameter is ensured by design and not 100% tested.
Note 3: The current measurement full scale range maximum value is 3.4A. However, the UCS2114 cannot report values above I_{LIM} (if $I_{BUS_R2MIN} \leq I_{LIM}$) or above I_{BUS_R2MIN} (if $I_{BUS_R2MIN} > I_{LIM}$ and $I_{LIM} \leq 1.6A$).

UCS2114

TABLE 1-1: ELECTRICAL SPECIFICATIONS (CONTINUED)

| Electrical Characteristics: Unless otherwise specified, $V_{DD} = 4.5V$ to $5.5V$, $V_S = 2.9V$ to $5.5V$, $V_{PULLUP} = 3V$ to $5.5V$, $T_A = -40^{\circ}C$ to $105^{\circ}C$. All typical values at $V_{DD} = V_S = 5V$, $T_A = 27^{\circ}C$. | | | | | | |
|---|-------------------|------|------|---------|---------|---|
| Characteristic | Symbol | Min. | Typ. | Max. | Unit | Conditions |
| I/O Pins - SMCLK, SMDATA, PWR_EN, ALERT#, BOOST# - DC Parameters | | | | | | |
| Output Low Voltage | V_{OL} | — | — | 0.4 | V | $I_{SINK_IO} = 8\text{ mA}$ SMDATA, ALERT#, BOOST# |
| Input High Voltage | V_{IH} | 2.0 | — | — | V | PWR_EN, SMDATA, SMCLK |
| Input Low Voltage | V_{IL} | — | — | 0.8 | V | PWR_EN, SMDATA, SMCLK |
| Leakage Current | I_{LEAK} | — | — | ± 5 | μA | Powered or unpowered $V_{PULLUP} \leq V_{DD}$ $T_A < 85^{\circ}C$ (Note 1) |
| Interrupt Pins - AC Parameters | | | | | | |
| ALERT# Pin Blanking Time | t_{BLANK} | — | 25 | — | ms | Blanking time, coming out of reset |
| ALERT# Pin Interrupt Masking Time | t_{MASK} | — | 5 | — | ms | |
| BOOST# Pin Minimum Assertion Time | t_{BOOST_MAT} | — | 1 | — | s | |
| BOOST# Pin Assertion Current | I_{BOOST} | — | 1.9 | — | A | |
| SMBus/I²C Timing | | | | | | |
| Input Capacitance | C_{IN} | — | 5 | — | pF | |
| Clock Frequency | f_{SMB} | 10 | — | 400 | kHz | |
| Spike Suppression | t_{SP} | — | — | 50 | ns | |
| Bus Free Time Stop to Start | t_{BUF} | 1.3 | — | — | μs | |
| Start Setup Time | $t_{SU:STA}$ | 0.6 | — | — | μs | |
| Start Hold Time | $t_{HD:STA}$ | 0.6 | — | — | μs | |
| Stop Setup Time | $t_{SU:STO}$ | 0.6 | — | — | μs | |
| Data Hold Time | $t_{HD:DAT}$ | 0 | — | — | μs | When transmitting to the master |
| Data Hold Time | $t_{HD:DAT}$ | 0.3 | — | — | μs | When receiving from the master |
| Data Setup Time | $t_{SU:DAT}$ | 0.6 | — | — | μs | |
| Clock Low Period | t_{LOW} | 1.3 | — | — | μs | |
| Clock High Period | t_{HIGH} | 0.6 | — | — | μs | |
| Clock/Data Fall Time | t_{FALL} | — | — | 300 | ns | Min. = $20+0.1C_{LOAD}$ ns (Note 1) |
| Clock/Data Rise Time | t_{RISE} | — | — | 300 | ns | Min. = $20+0.1C_{LOAD}$ ns (Note 1) |
| Capacitive Load | C_{LOAD} | — | — | 400 | pF | Per bus line (Note 1) |
| Time Out | $t_{TIMEOUT}$ | 25 | — | 35 | ms | Disabled by default (Note 1) |
| Idle Reset | t_{IDLE_RESET} | 350 | — | — | μs | Disabled by default (Note 1) |

Note 1: This parameter is characterized, not 100% tested.

2: This parameter is ensured by design and not 100% tested.

3: The current measurement full scale range maximum value is 3.4A. However, the UCS2114 cannot report values above I_{LIM} (if $I_{BUS_R2MIN} \leq I_{LIM}$) or above I_{BUS_R2MIN} (if $I_{BUS_R2MIN} > I_{LIM}$ and $I_{LIM} \leq 1.6A$).

TABLE 1-1: ELECTRICAL SPECIFICATIONS (CONTINUED)

| Electrical Characteristics: Unless otherwise specified, $V_{DD} = 4.5V$ to $5.5V$, $V_S = 2.9V$ to $5.5V$, $V_{PULLUP} = 3V$ to $5.5V$, $T_A = -40^{\circ}C$ to $105^{\circ}C$. All typical values at $V_{DD} = V_S = 5V$, $T_A = 27^{\circ}C$. | | | | | | |
|--|---------------------|------|------|------|-------------|--|
| Characteristic | Symbol | Min. | Typ. | Max. | Unit | Conditions |
| Port Power Switch | | | | | | |
| Port Power Switch - DC Parameter | | | | | | |
| Overvoltage Lockout | V_{S_OV} | — | 6 | — | V | Note 2 |
| V_S Low Threshold | V_{S_UVLO} | — | 2.5 | — | V | Note 2 |
| V_S Low Hysteresis | $V_{S_UVLO_HYST}$ | — | 100 | — | mV | Note 2 |
| On Resistance | R_{ON_PSW} | — | 18 | 30 | m Ω | $4.75V < V_S < 5.25V$ |
| V_S Leakage Current | I_{LEAK_VS} | — | — | 5 | μA | Sleep state into V_S pin on one channel (Note 1) |
| Back-Voltage Protection Threshold | V_{BV_TH} | — | 150 | — | mV | $V_{BUS} > V_S$ $V_S > V_{S_UVLO}$ |
| Leakage Current | I_{LKG_1} | — | 0 | 3 | μA | $V_{DD} < V_{DD_TH}$, Leakage current from V_{BUS} pins to the V_{DD} and the V_S pins (Note 1) |
| | I_{LKG_2} | — | 0 | 2 | μA | $V_{DD} > V_{DD_TH}$, Leakage current from V_{BUS} pins to the V_S pins, when the power switch is open |
| Selectable Current Limits | I_{LIM1} | — | 530 | — | mA | I_{LIM} Resistor = 0 or 47 k Ω (530 mA setting) |
| | I_{LIM2} | — | 960 | — | mA | I_{LIM} Resistor = 10 k Ω or 56 k Ω (960 mA setting) |
| | I_{LIM3} | — | 1070 | — | mA | I_{LIM} Resistor = 12 k Ω or 68 k Ω (1070 mA setting) |
| | I_{LIM4} | — | 1280 | — | mA | I_{LIM} Resistor = 15 k Ω or 82 k Ω (1280 mA setting) |
| | I_{LIM5} | — | 1600 | — | mA | I_{LIM} Resistor = 18 k Ω or 100 k Ω (1600 mA setting) |
| | I_{LIM6} | — | 2130 | — | mA | I_{LIM} Resistor = 22 k Ω or 120 k Ω (2130 mA setting) |
| | I_{LIM7} | 2500 | 2670 | 2900 | mA | I_{LIM} Resistor = 27 k Ω or 150 k Ω (2670 mA setting) |
| | I_{LIM8} | 3000 | 3200 | 3400 | mA | I_{LIM} Resistor = 33 k Ω or V_{DD} (3200 mA setting) |
| Pin Wake Time | t_{PIN_WAKE} | — | 3 | — | ms | |
| SMBus Wake Time | t_{SMB_WAKE} | — | 4 | — | ms | |
| Idle Sleep Time | t_{IDLE_SLEEP} | — | 200 | — | ms | |
| First Thermal Shutdown Stage Threshold | T_{TSD_LOW} | — | 120 | — | $^{\circ}C$ | Die Temperature at which the power switch will open if it is in Constant Current mode |

- Note 1:** This parameter is characterized, not 100% tested.
Note 2: This parameter is ensured by design and not 100% tested.
Note 3: The current measurement full scale range maximum value is 3.4A. However, the UCS2114 cannot report values above I_{LIM} (if $I_{BUS_R2MIN} \leq I_{LIM}$) or above I_{BUS_R2MIN} (if $I_{BUS_R2MIN} > I_{LIM}$ and $I_{LIM} \leq 1.6A$).

UCS2114

TABLE 1-1: ELECTRICAL SPECIFICATIONS (CONTINUED)

| Electrical Characteristics: Unless otherwise specified, $V_{DD} = 4.5V$ to $5.5V$, $V_S = 2.9V$ to $5.5V$, $V_{PULLUP} = 3V$ to $5.5V$, $T_A = -40^{\circ}C$ to $105^{\circ}C$. All typical values at $V_{DD} = V_S = 5V$, $T_A = 27^{\circ}C$. | | | | | | |
|--|---------------------------|------|------|------|-------------|---|
| Characteristic | Symbol | Min. | Typ. | Max. | Unit | Conditions |
| First Thermal Shutdown Stage Hysteresis | $T_{TSD_LOW_HYST}$ | — | 10 | — | $^{\circ}C$ | Hysteresis for T_{TSD_LOW} functionality. Temperature must drop by this value before any of the power switches can be closed. |
| Second Thermal Shutdown Stage Threshold | T_{TSD_HIGH} | — | 135 | — | $^{\circ}C$ | Die Temperature at which both power switches will open |
| Second Thermal Shutdown Stage Hysteresis | $T_{TSD_HIGH_HYST}$ | — | 25 | — | $^{\circ}C$ | Hysteresis for T_{TSD_HIGH} functionality. Temperature must drop by this value before any of the power switches can be closed. |
| Auto-Recovery Test Current | I_{TEST} | — | 190 | — | mA | Portable device attached, $V_{BUS} = 0V$, Die temp $< T_{TSD}$ |
| Auto-Recovery Test Voltage | V_{TEST} | — | 750 | — | mV | Portable device attached, $V_{BUS} = 0V$ before application, Die temp $< T_{TSD}$ Programmable, 250-1000 mV, default listed |
| Discharge Impedance | $R_{DISCHARGE}$ | — | 100 | — | Ω | |
| Port Power Switch - AC Parameters | | | | | | |
| Turn-on Delay | t_{ON_PSW} | — | 0.9 | — | ms | PWR_EN active toggle to switch on time, V_{BUS} discharge not active |
| Turn-off Time | $t_{OFF_PSW_INA}$ | — | 0.75 | — | ms | PWR_EN inactive toggle to switch off time $C_{BUS} = 120 \mu F$ |
| Turn-off Time | $t_{OFF_PSW_ERR}$ | — | 1 | — | ms | Overcurrent Error, V_{BUS} Min Error, or Discharge Error to switch off $C_{BUS} = 120 \mu F$ |
| Turn-off Time | $t_{OFF_PSW_ERR1}$ | — | 100 | — | ns | TSD or Back-drive Error to switch off $C_{BUS} = 120 \mu F$ |
| V_{BUS} Output Rise Time | t_{R_BUS} | — | 1.1 | — | ms | Measured from 10% to 90% of V_{BUS} , $C_{LOAD} = 220 \mu F$ $I_{LIM} = 1.0A$ |
| Soft Turn-On Rate | $\Delta I_{BUS}/\Delta t$ | — | 100 | — | mA/ μs | |
| Temperature Update Time | t_{DC_TEMP} | — | 200 | — | ms | |
| Short-Circuit Response Time | t_{SHORT_LIM} | — | 1.5 | — | μs | Time from detection of short to current limit applied. No C_{BUS} applied |
| Short-Circuit Detection Time | t_{SHORT} | — | 6 | — | ms | Time from detection of short to port power switch disconnect and ALERT# pin assertion |

- Note**
- 1: This parameter is characterized, not 100% tested.
 - 2: This parameter is ensured by design and not 100% tested.
 - 3: The current measurement full scale range maximum value is 3.4A. However, the UCS2114 cannot report values above I_{LIM} (if $I_{BUS_R2MIN} \leq I_{LIM}$) or above I_{BUS_R2MIN} (if $I_{BUS_R2MIN} > I_{LIM}$ and $I_{LIM} \leq 1.6A$).

TABLE 1-1: ELECTRICAL SPECIFICATIONS (CONTINUED)

| Electrical Characteristics: Unless otherwise specified, $V_{DD} = 4.5V$ to $5.5V$, $V_S = 2.9V$ to $5.5V$, $V_{PULLUP} = 3V$ to $5.5V$, $T_A = -40^{\circ}C$ to $105^{\circ}C$. All typical values at $V_{DD} = V_S = 5V$, $T_A = 27^{\circ}C$. | | | | | | |
|--|---------------------|------|-----------|------|------|---|
| Characteristic | Symbol | Min. | Typ. | Max. | Unit | Conditions |
| Latched Mode Cycle Time | t_{UL} | — | 7 | — | ms | From PWR_EN edge transition from inactive to active to begin error recovery. |
| Auto-Recovery Mode Cycle Time | t_{CYCLE} | — | 25 | — | ms | Time delay before error condition check. Programmable 15-50 ms, default listed. |
| Auto-Recovery Delay | t_{TST} | — | 20 | — | ms | Portable device attached, V_{BUS} must be $\geq V_{TEST}$ after this time. Programmable 10-25 ms, default listed. |
| Discharge Time | $t_{DISCHARGE}$ | — | 200 | — | ms | Amount of time discharge resistor applied. Programmable 100-400 ms, default listed. |
| Port Power Switch Operation with Trip Mode Current Limiting | | | | | | |
| Region 2 Current Keep-Out | $I_{BUS_R2MIN_1}$ | — | — | 0.1 | A | Note 2 |
| Minimum V_{BUS} Allowed at Output | $V_{BUS_MIN_1}$ | 2.0 | — | — | V | Note 2 |
| Port Power Switch Operation with Constant Current Limiting (Variable Slope) | | | | | | |
| Region 2 Current Keep-Out | I_{BUS_R2MIN} | — | — | 2.13 | A | Note 2 |
| Minimum V_{BUS} Allowed at Output | V_{BUS_MIN} | 2.0 | — | — | V | Note 2 |
| Current Measurement - DC | | | | | | |
| Current Measurement Range | I_{BUS_M} | 0 | — | 3400 | mA | Range (Note 2 and Note 3) |
| Reported Current Measurement Resolution | ΔI_{BUS_M} | — | 13.3 | — | mA | 1 LSB |
| Current Measurement Accuracy | | — | ± 2 | — | % | $200\text{ mA} < I_{BUS} < I_{LIM}$ |
| | | — | ± 2 | — | LSB | $I_{BUS} < 200\text{ mA}$ |
| Current Measurement - AC | | | | | | |
| Sampling Rate | — | — | 1.1 | — | ms | Note 2 |
| Conversion Time Both Channels | t_{CONV} | — | 2.2 | — | ms | All registers updated in digital (Note 2) |
| Charge Rationing - DC | | | | | | |
| Accumulated Current Measurement Accuracy | — | — | ± 4.5 | — | % | |
| Charge Rationing - AC | | | | | | |
| Current Measurement Update Time | t_{PCYCLE} | — | 1 | — | s | |

Note 1: This parameter is characterized, not 100% tested.

Note 2: This parameter is ensured by design and not 100% tested.

Note 3: The current measurement full scale range maximum value is 3.4A. However, the UCS2114 cannot report values above I_{LIM} (if $I_{BUS_R2MIN} \leq I_{LIM}$) or above I_{BUS_R2MIN} (if $I_{BUS_R2MIN} > I_{LIM}$ and $I_{LIM} \leq 1.6A$).

UCS2114

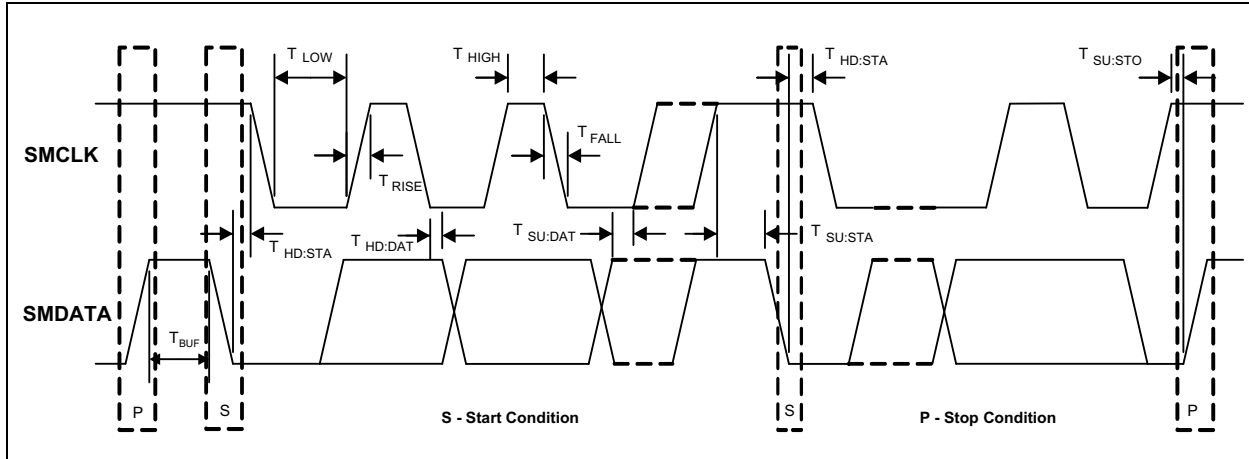

FIGURE 1-1: SMBus Timing.

TABLE 1-2: TEMPERATURE SPECIFICATIONS

| Parameters | Sym. | Min. | Typ. | Max. | Units | Conditions |
|------------------------------------|---------------|------|------|------|-------|---|
| Temperature Ranges | | | | | | |
| Operating Temperature Range | T_A | -40 | — | +105 | °C | |
| Operating Junction Temperature | T_J | -40 | — | +125 | °C | |
| Storage Temperature Range | T_A | -55 | — | +150 | °C | |
| Thermal Package Resistances | | | | | | |
| 3x3 mm 20-pin VQFN | θ_{JA} | — | 48 | — | °C/W | Typical 4-layer board with interconnecting vias, recommended land pattern from this document. |

1.1 ESD and Transient Performance

TABLE 1-3: ESD RATINGS

| ESD Specification | Rating or Value |
|---|-----------------|
| Human Body Model (JEDEC JESD22-A114) - All pins | 8 kV |
| Charged Device Model (JEDEC JESD22-C101) - All pins | 500V |

1.1.1 HUMAN BODY MODEL (HBM) PERFORMANCE

HBM testing verifies the ability to withstand ESD strikes, like those that occur during handling and manufacturing, and is done without power applied to the IC. To pass the test, the device must have no change in operation or performance due to the event.

1.1.2 CHARGED DEVICE MODEL (CDM) PERFORMANCE

CDM testing verifies the ability to withstand ESD strikes, like those that occur during handling and assembly, with pick-and-place-style machinery and is done without power applied to the IC. To pass the test, the device must have no change in operation or performance due to the event.

UCS2114

NOTES:

2.0 TYPICAL PERFORMANCE CURVES

Note: The graphs and tables provided following this note are a statistical summary based on a limited number of samples and are provided for informational purposes only. The performance characteristics listed herein are not tested or guaranteed. In some graphs or tables, the data presented may be outside the specified operating range (e.g., outside specified power supply range) and therefore outside the warranted range.

Note: Unless otherwise indicated, $V_{DD} = V_S = 5V$, $T_A = +27^\circ C$.

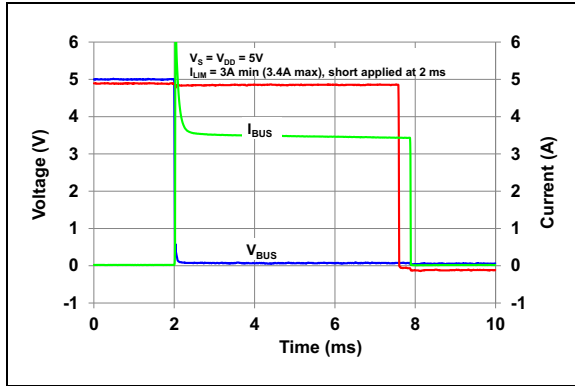

FIGURE 2-1: Short Applied after Power-Up.

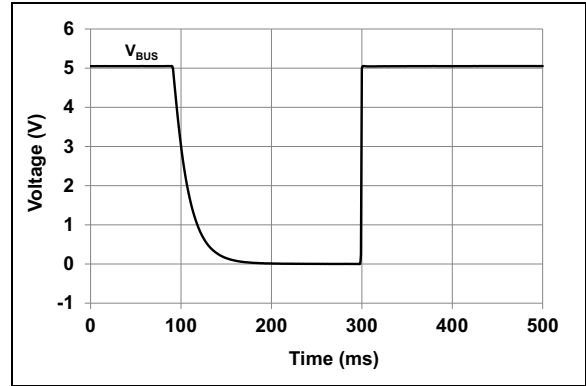

FIGURE 2-4: V_{BUS} Discharge Behavior.

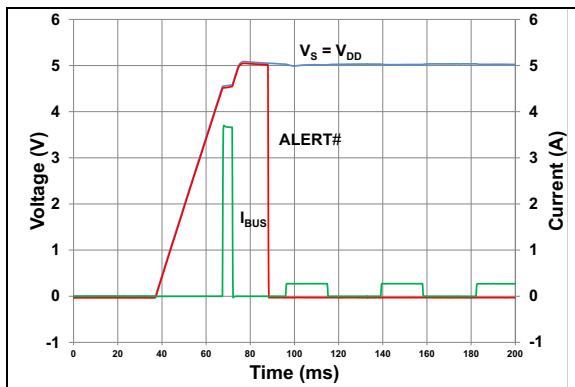

FIGURE 2-2: Power-Up Into a Short.

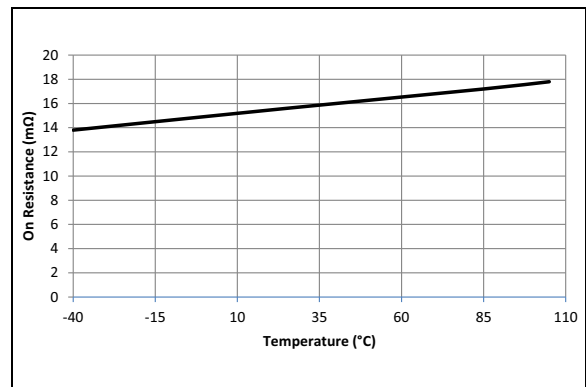

FIGURE 2-5: Power Switch On Resistance vs. Temperature.

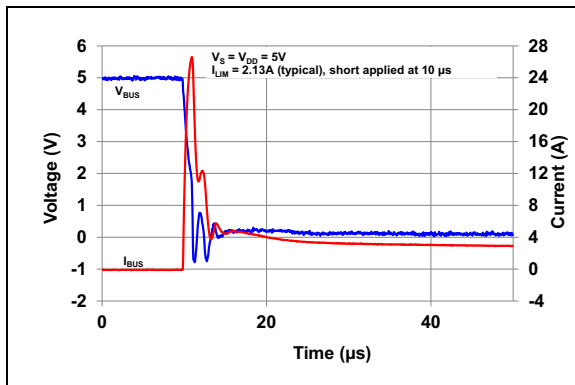

FIGURE 2-3: Internal Power Switch Short Response.

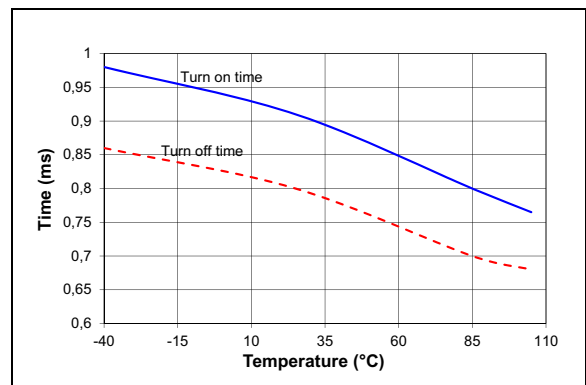

FIGURE 2-6: Power Switch On/Off Time vs. Temperature.

UCS2114

Note: Unless otherwise indicated, $V_{DD} = V_S = 5V$, $T_A = +27^\circ C$.

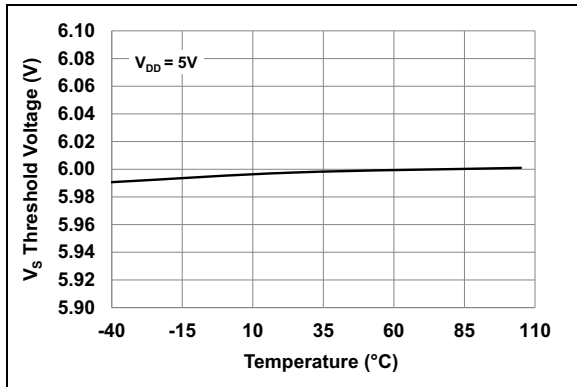

FIGURE 2-7: V_S Overvoltage Threshold vs. Temperature.

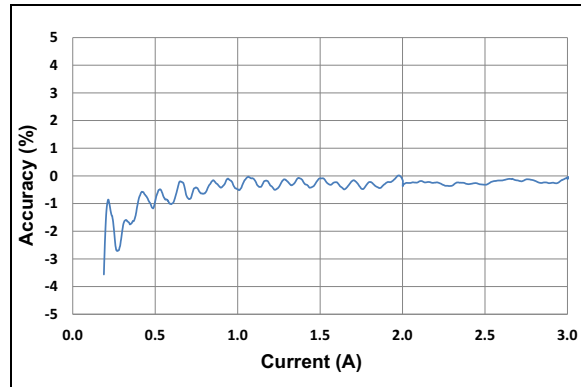

FIGURE 2-10: I_{BUS} Measurement Accuracy.

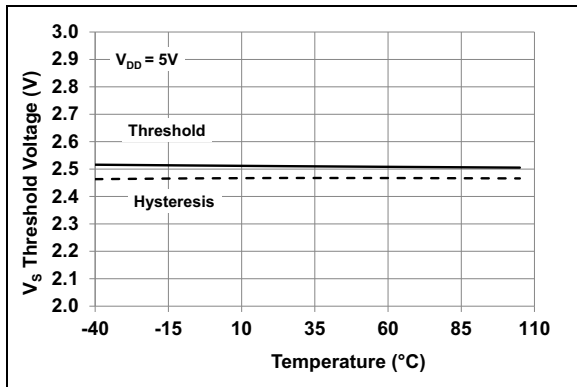

FIGURE 2-8: V_S Undervoltage Threshold vs. Temperature.

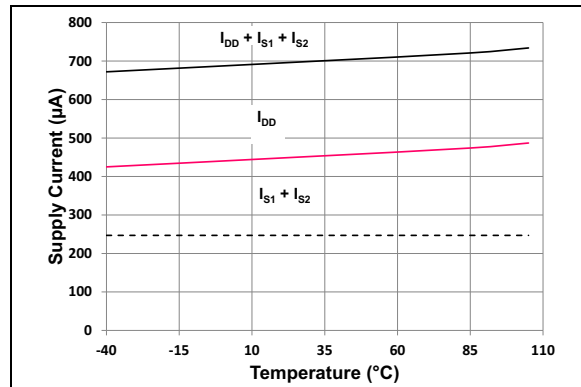

FIGURE 2-11: Active State Current vs. Temperature (both channels on, $PWR_EN1 = PWR_EN2 = 1$).

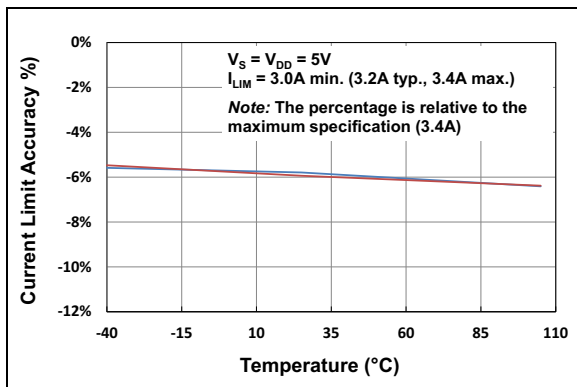

FIGURE 2-9: Trip Current Limit Operation vs. Temperature.

Note: Unless otherwise indicated, $V_{DD} = V_S = 5V$, $T_A = +27^\circ C$.

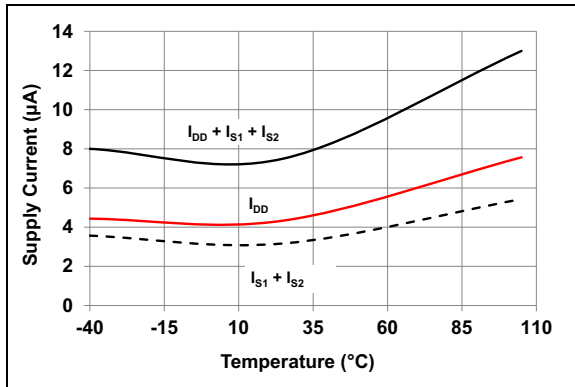

FIGURE 2-12: Sleep State Current vs. Temperature.

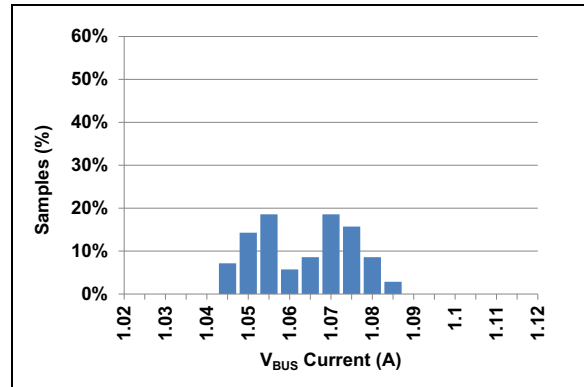

FIGURE 2-15: ILIM3 Trip Current Distribution⁽¹⁾.

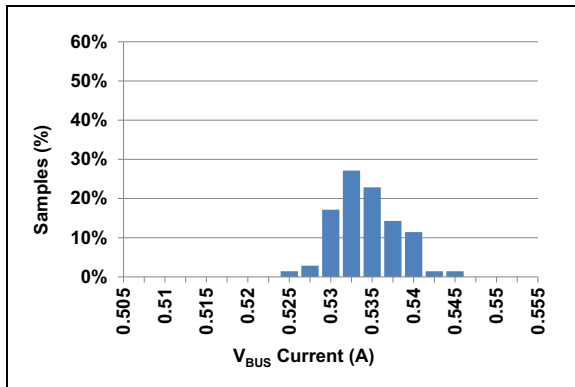

FIGURE 2-13: ILIM1 Trip Current Distribution.

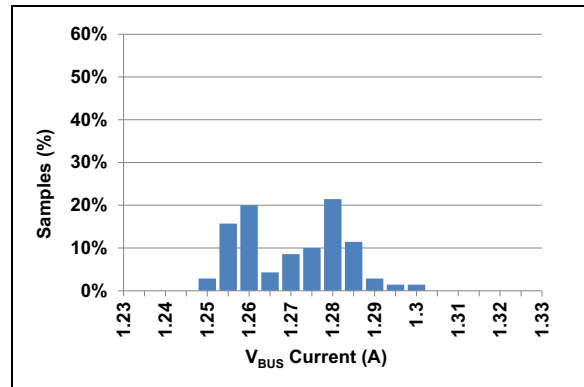

FIGURE 2-16: ILIM4 Trip Current Distribution⁽¹⁾.

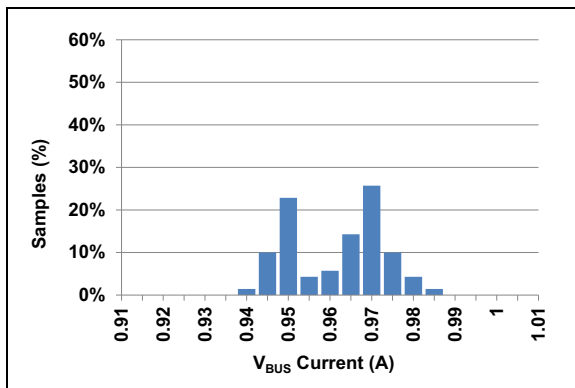

FIGURE 2-14: ILIM2 Trip Current Distribution⁽¹⁾.

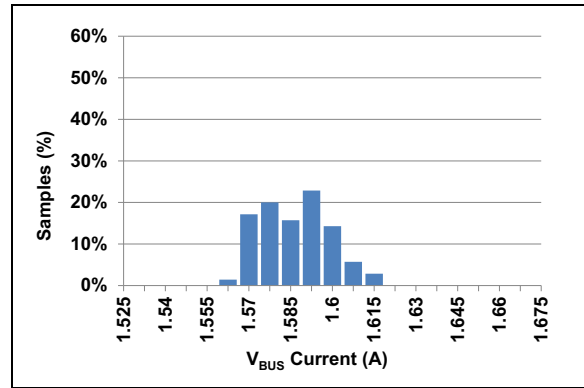

FIGURE 2-17: ILIM5 Trip Current Distribution⁽¹⁾.

Note 1: The histogram aspect is caused by a mixture of two normal distributions, corresponding to the two V_{BUS} channels.

Note: Unless otherwise indicated, $V_{DD} = V_S = 5V$, $T_A = +27^\circ C$.

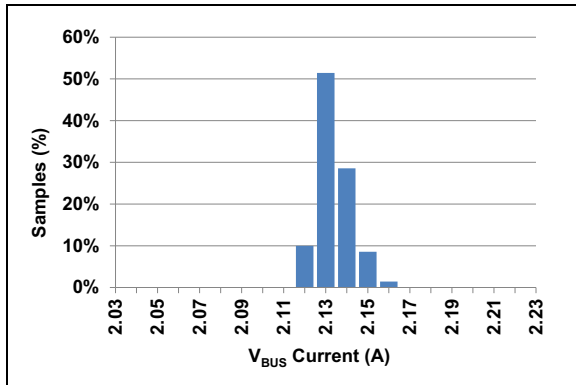

FIGURE 2-18: ILIM6 Trip Current Distribution.

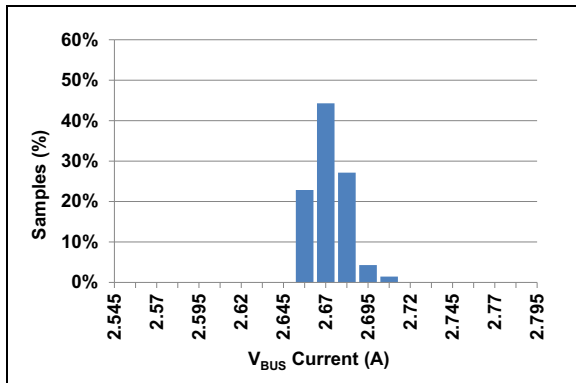

FIGURE 2-19: ILIM7 Trip Current Distribution.

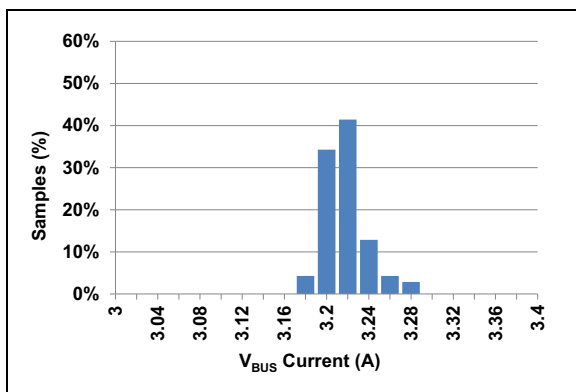

FIGURE 2-20: ILIM8 Trip Current Distribution.

Note 1: The histogram aspect is caused by a mixture of two normal distributions, corresponding to the two V_{BUS} channels.

3.0 PIN DESCRIPTION

Descriptions of the pins are listed in [Table 3-1](#).

TABLE 3-1: PIN FUNCTION TABLE

| UCS2114 3x3 VQFN | Symbol | Function | Pin Type | Connection Type if Pin Not Used |
|---------------------|------------|---|-----------------|---|
| 1 | PWR_EN1 | Port power switch enable #1 | DI | Connect to ground or V_{DD} (depending on the polarity decoded via COMM_ILIM pin) |
| 2 | GND | Ground | Power | N/A |
| 3 | COMM_ILIM | Enables SMBus or Stand-Alone mode at power-up. Hardware strap for maximum current limit. | AIO | N/A |
| 4, 5 | V_{BUS1} | Port power switch #1 output (requires both pins tied together) | High Power, AIO | Leave open |
| 6, 7 | V_S | Voltage input to port power switch V_{BUS1} (requires both pins tied together) | High Power, AIO | Connect to ground |
| 8 | V_{DD} | Common supply voltage | Power | N/A |
| 9, 10 | V_S | Voltage input to port power switch V_{BUS2} (requires both pins tied together) | High Power, AIO | Connect to ground |
| 11, 12 | V_{BUS2} | Port power switch #2 output (requires both pins tied together) | High Power, AIO | Leave open |
| 13 | BOOST# | Logic output for DC-DC converter voltage increase (requires pull-up resistor) | OD | Connect to ground |
| 14 | GND | Ground | Power | N/A |
| 15 | PWR_EN2 | Port power switch enable #2 | DI | Connect to ground or V_{DD} (depending on the polarity decoded via COMM_ILIM pin) |
| 16 | ALERT#2 | Output fault ALERT for V_{BUS2} (requires pull-up resistor) | OD | Connect to ground |
| 17 | GND | Ground | Power | N/A |
| 18 | SMDATA | SMDATA - SMBus data input/output (requires pull-up resistor) | DIOD | Connect to V_{PULLUP} (or to ground in Stand-Alone mode) |
| 19 | SMCLK | SMCLK - SMBus clock input (requires pull-up resistor) | DI | Connect to V_{PULLUP} (or to ground in Stand-Alone mode) |
| 20 | ALERT#1 | Output fault ALERT for V_{BUS1} (requires pull-up resistor) | OD | Connect to ground |

UCS2114

TABLE 3-2: PIN TYPES

| Pin Type | Description |
|-----------------|--|
| Power | This pin is used to supply power or ground to the device |
| Hi-Power | This pin is a high-current pin |
| AIO | Analog Input/Output - this pin is used as an I/O for analog signals |
| DI | Digital Input - this pin is used as a digital input |
| DIOD | Open-Drain Digital Input/Output - this pin is bidirectional. It is open-drain and requires a pull-up resistor. |
| OD | Open-Drain Digital Output - used as a digital output. It is open-drain and requires a pull-up resistor. |

4.0 TERMS AND ABBREVIATIONS

Note: The PWR_EN2 and PWR_EN1 pins each have configuration bits (“<pin name>_S” in [General Configuration 2 register \(Address 11h\)](#) and [General Configuration 1 register \(Address 12h\)](#)) that may be used to perform the same function as the external pin state. These bits are accessed via the SMBus/I²C and are OR’d with the respective pin. This OR’d combination of pin state and register bit is referenced as the <pin name> control.

TABLE 4-1: TERMS AND ABBREVIATIONS

| Term/Abbreviation | Description |
|------------------------|---|
| CC | Constant Current |
| Current Limiting mode | Determines the action that is performed when the I _{BUS} current reaches the I _{LIM} threshold. Trip opens the port power switch. Constant Current (variable slope) allows V _{BUS} to be dropped by the portable device. |
| I _{BUS_R2MIN} | Current limiter mode boundary |
| I _{LIM} | The I _{BUS} current threshold used in current limiting. In Trip mode, when I _{LIM} is reached, the port power switch is opened. In Constant Current mode, when the current exceeds I _{LIM} , operation continues at a reduced voltage and increased current; if V _{BUS} voltage drops below V _{BUS_MIN} , the port power switch is opened. |
| OCL | Overcurrent limit |
| POR | Power-on Reset |
| Portable Device | USB device attached to the USB port |
| Stand-Alone mode | Indicates that the communications protocol is not active and all communications between the UCS2114 and a controller are done via the external pins only (PWR_EN1 and PWR_EN2 as inputs, and ALERT1# and ALERT2# as outputs) |

UCS2114

NOTES:

5.0 GENERAL DESCRIPTION

The UCS2114 is a dual-port power switch. Two USB power ports are supported with current limits up to 3.0A continuous current (3.4A maximum) each. Selectable and programmable current limiting configurations are also available to the application. A typical block diagram is shown in [Figure 5-1](#).

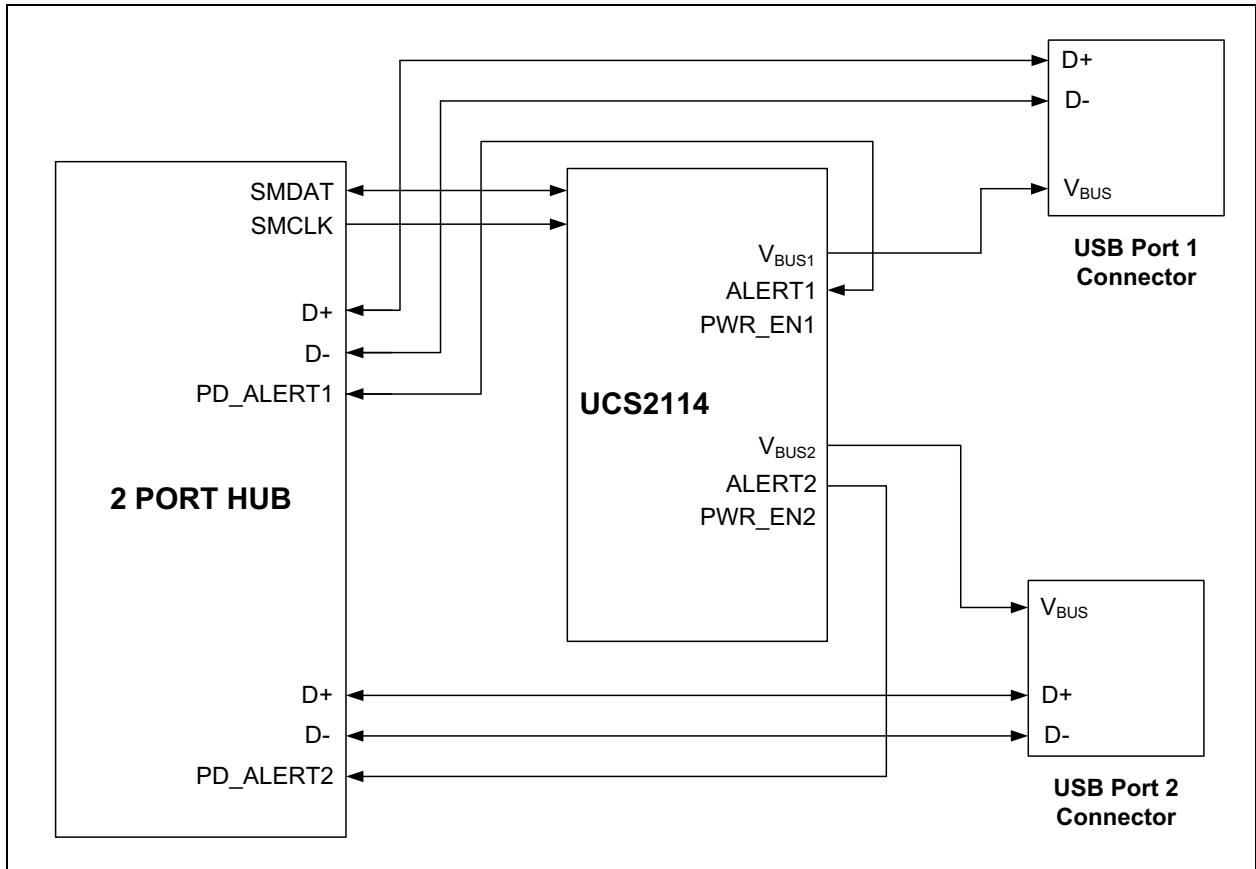

FIGURE 5-1: Typical USB Application.

UCS2114

5.1 UCS2114 Power States

Power states are indicators of the device's current consumption in the system and of the functionality of the digital logic. [Table 5-1](#) details the UCS2114 power states.

TABLE 5-1: POWER STATES DESCRIPTION

| State | Description |
|---------------|---|
| Off | This power state is entered when the voltage at the V_{DD} pin voltage is $< V_{DD_TH}$. In this state, the device is considered "off". The UCS2114 will not retain its digital states and register contents nor respond to SMBus/I ² C communications. The port power switch will be off. See Section 5.1.1 "Off State Operation" . |
| Sleep | This is the lowest power state available. While in this state, the UCS2114 will retain digital functionality and wake to respond to SMBus/I ² C communications. See Section 5.1.2 "Sleep State Operation" . |
| Error | This power state is entered when a fault condition exists. Error power state is one or both channels in Fault Handling. This state is updated as Priority One. The Interrupt Status registers for each channel will update the fault detected per channel. Only the channel that has detected a Fault will be affected since the other channel can remain active if no fault is detected. See Section 5.1.4 "Error State Operation" . |
| Active | Active power State is one, or both channels active and sourcing current to the V_{BUS} Port. This state is updated as Priority Two. None of the channels have detected Fault. This power state provides full functionality. While in this state, operations include activation of the port power switch, current limiting and charge rationing. See Section 5.1.3 "Active State Operation" . |

[Table 5-2](#) shows the settings for the various power states, except Off and Error. If $V_{DD} < V_{DD_TH}$, the UCS2114 is in the Off state.

TABLE 5-2: POWER STATES CONTROL SETTINGS

| Power State | PWR_EN1 | PWR_EN2 | Behavior |
|-------------|----------|----------|--|
| Sleep | disabled | disabled | <ul style="list-style-type: none"> All switches disabled V_{BUS} will be near ground potential The UCS2114 wakes to respond to SMBus communications |
| Active | enabled | disabled | <ul style="list-style-type: none"> Port power switch is on for V_{BUS1} V_{BUS2} pins are near ground potential or floating (Note 1) |
| | disabled | enabled | <ul style="list-style-type: none"> Port power switch is on for V_{BUS2} V_{BUS1} pins are near ground potential or floating (Note 1) |
| | enabled | enabled | <ul style="list-style-type: none"> Port power switch is on for V_{BUS1} and V_{BUS2} |

Note 1: If the bit EN_VBUS_DISCHG is '1', the V_{BUS} is discharged automatically and V_{BUS} is near ground potential. If the bit EN_VBUS_DISCHG is '0', then the corresponding V_{BUS} pins are floating (V_{BUS} discharge is controlled by the SMBus master).

5.1.1 OFF STATE OPERATION

The device will be in the Off state if V_{DD} is less than V_{DD_TH} . When the UCS2114 is in the Off state, it will do nothing and all circuitry will be disabled. Digital register values are not stored and the device will not respond to SMBus commands.

5.1.2 SLEEP STATE OPERATION

The PWR_EN1 and PWR_EN2 pins may be used to cause the UCS2114 to enter/exit Sleep. These pins are AND'ed for Sleep mode.

When the UCS2114 is in the Sleep state, the device will be in its lowest power state. The port power switch will be disabled. V_{BUS1} and V_{BUS2} will be near ground

potential. The ALERT#1 and ALERT#2 pins will not be asserted. If asserted prior to entering the Sleep state, the ALERT# pin will be released. SMBus activity is limited to single byte read or write.

The first data byte read from the UCS2114 when it is in the Sleep state will wake it; however, the data to be read will return all 0's and should be considered invalid. This is a "dummy" read byte meant to wake the UCS2114. Subsequent read or write bytes will be accepted normally. After the dummy read, the UCS2114 will be in a higher power state (see [Figure 5-2](#)). After communication has not occurred for t_{IDLE_SLEEP} , the UCS2114 will return to Sleep.

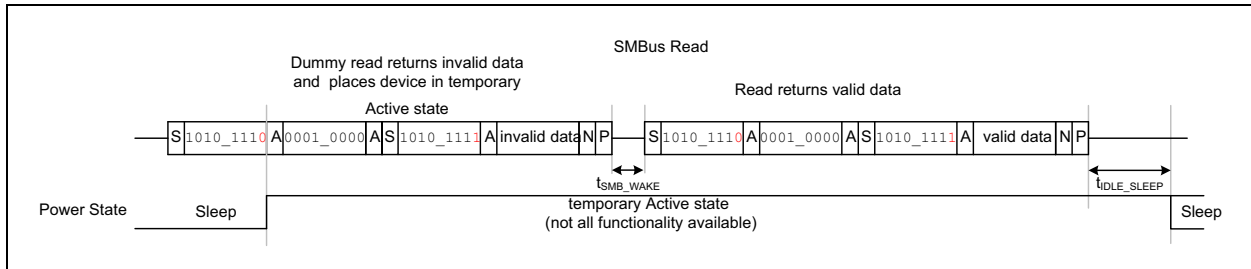

FIGURE 5-2: Wake from Sleep using SMBus Read.

5.1.3 ACTIVE STATE OPERATION

Every time the UCS2114 enters the Active state, the port power switches are closed. The UCS2114 cannot be in the Active state (and therefore, the port power switch cannot be turned on) if any of the following conditions exist:

- $V_S < V_{S_UVLO}$
- PWR_EN1 and PWR_EN2 are disabled.

5.1.4 ERROR STATE OPERATION

The UCS2114 will enter the Error state from the Active state when any of the following events are detected:

- The maximum allowable internal die temperature (T_{TSD_HIGH}) has been exceeded.
- The T_{TSD_LOW} die temperature has been exceeded and any of the following conditions is met:
 - a power switch operates in Constant Current mode.
 - PWR_EN1 and/or PWR_EN2 controls transition from inactive to active.
 - it is a power-up situation and PWR_EN1 and/or PWR_EN2 pins are active.
- An overcurrent condition has been detected.
- An undervoltage condition on either V_{BUS} pin has been detected (see [Section 5.3.4 “Undervoltage Lockout on VS”](#)).
- A back-voltage condition has been detected (see [Section 5.3.2 “Back-Voltage Detection”](#)).
- A discharge error has been detected.
- An overvoltage condition on the V_S pin.

When the UCS2114 enters the Error state, the port power switch will be disabled while the ALERT# pin is asserted. It will remain off while in this power state. The UCS2114 will leave this state as determined by the fault handling selection.

With the Auto-recovery fault handler, after the t_{CYCLE} time period, the UCS2114 will check that all of the error conditions have been removed.

If all of the error conditions have been removed, the UCS2114 will return to the Active state.

If both PWR_EN1 and PWR_EN2 controls transition from active to inactive while the UCS2114 is in the Error state, the device will not enter the Sleep state. After the fault has been removed, the UCS2114 will not automatically enter the Sleep state if the EN_VBUS_DISCHG bit from the General Configuration 1 register is not set (default setting). To enter the Sleep state, the PWR_EN pins must be toggled or an SMBus read register command must be sent.

UCS2114

5.2 Communication

The UCS2114 can operate in SMBus mode (see [Section 7.0 “System Management Bus Protocol”](#)) or Stand-Alone mode. The resistor connected to the COMM_ILIM pin determines the operating mode and

the hardware-set I_{LIM} setting, as shown in [Table 5-3](#). Unless connected to GND or V_{DD} , the resistors in [Table 5-3](#) are external pull-down resistors.

The SMBus address is specified in [Section 7.2 “SMBus Address and RD/WR Bit”](#).

TABLE 5-3: COMMUNICATION DECODE

| COMM_ILIM Pull Down Resistor ($\pm 1\%$) | PWR_EN1 and PWR_EN2 Polarity | I_{LIM} (A) | Total I_{LIM} (A) (Note 1) | Communication Mode |
|--|------------------------------|---------------|------------------------------|--------------------|
| GND | Active-High | 0.53 | 0.53 + 0.53 | SMBUS |
| 10 k Ω | Active-High | 0.96 | 0.96 + 0.96 | SMBUS |
| 12 k Ω | Active-High | 1.07 | 1.07 + 1.07 | SMBUS |
| 15 k Ω | Active-High | 1.28 | 1.28 + 1.28 | SMBUS |
| 18 k Ω | Active-High | 1.6 | 1.6 + 1.6 | SMBUS |
| 22 k Ω | Active-High | 2.13 | 2.13 + 2.13 | SMBUS |
| 27 k Ω | Active-High | 2.67 | 2.67 + 2.67 | SMBUS |
| 33 k Ω | Active-High | 3.2 | 3.2 + 3.2 | SMBUS |
| 47 k Ω | Active-Low | 0.53 | 0.53 + 0.53 | Stand-Alone |
| 56 k Ω | Active-Low | 0.96 | 0.96 + 0.96 | Stand-Alone |
| 68 k Ω | Active-Low | 1.07 | 1.07 + 1.07 | Stand-Alone |
| 82 k Ω | Active-Low | 1.28 | 1.28 + 1.28 | Stand-Alone |
| 100 k Ω | Active-Low | 1.6 | 1.6 + 1.6 | Stand-Alone |
| 120 k Ω | Active-Low | 2.13 | 2.13 + 2.13 | Stand-Alone |
| 150 k Ω | Active-Low | 2.67 | 2.67 + 2.67 | Stand-Alone |
| V_{DD} | Active-Low | 3.2 | 3.2 + 3.2 | Stand-Alone |

Note 1: The total maximum current depends on the power dissipation characteristics of the design (see [Table 1-1](#)).

5.3 Supply Voltages

5.3.1 V_{DD} SUPPLY VOLTAGE

The UCS2114 requires 4.5V to 5.5V to be present on the V_{DD} pin for core device functionality. Core device functionality consists of maintaining register states and wake-up upon SMBus/I²C query.

5.3.2 BACK-VOLTAGE DETECTION

The back-voltage detector is functional in all power states (Sleep and Active).

When in Sleep, the UCS2114 will enter the Error state from Sleep if a back-voltage condition was detected.

Whenever the following condition is true for either port, the port power switch will be disabled and a back-voltage event will be flagged. This will cause the UCS2114 to enter the Error power state (see [Section 5.1.4 “Error State Operation”](#)).

Note: The V_{BUS} voltage exceeds the V_S and/or the V_{DD} pin voltage by V_{BV_TH} and the port power switch is closed. The port power switch will be opened immediately. If the condition lasts for longer than t_{MASK} , then the UCS2114 will enter the Error state. Otherwise, the port power switch will be turned on as soon as the condition is removed.

5.3.3 BACK-DRIVE CURRENT PROTECTION

If a portable self-powered device is attached, it may drive the V_{BUS} port to its power supply voltage level; however, the UCS2114 is designed such that leakage current from the V_{BUS} pins to the V_{DD} and/or the V_S pin shall not exceed I_{LKG_1} (if the V_{DD} and/or V_S voltage is zero) or I_{LKG_2} (if the V_{DD} and/or V_S voltage exceeds V_{DD_TH} and the power switch is open).

5.3.4 UNDERVOLTAGE LOCKOUT ON V_S

The UCS2114 requires a minimum voltage (V_{S_UVLO}) to be present on the V_S pin for Active power state.

5.3.5 OVERVOLTAGE DETECTION AND LOCKOUT ON V_S

Both power switches will be disabled if the voltage on any V_S pin exceeds a voltage (V_{S_OV}) for longer than the specified time (t_{MASK}). This will cause the device to enter the Error state and both ALERT#1 and ALERT#2 pins will be asserted.

5.3.6 PWR_EN1 AND PWR_EN2 INPUT

The PWR_EN control affects the power state and enables the port power switch to be turned on if conditions are met (see [Table 5-2](#)). The port power switch cannot be closed if PWR_EN is disabled. However, if PWR_EN is enabled, the port power switch is not necessarily closed (see [Section 5.1.3 “Active State Operation”](#)). In SMBus mode, the PWR_EN1 and PWR_EN2 pins states will be ignored by the UCS2114 if the PIN_IGN configuration bit is set; otherwise, the PWR_EN1S and PWR_EN2S configuration bits are checked along with the pins.

UCS2114

5.4 Discrete Output Pins

5.4.1 ALERT#1 AND ALERT#2 OUTPUT PINS

The UCS2114 has two independent ALERT# out pins. ALERT#1 is tied to the status of the V_{BUS1} pin. ALERT#2 is tied to the status of the V_{BUS2} pin.

The ALERT# pin is an active-low open-drain interrupt to the host controller. The ALERT# pin is asserted when an error occurs. Also, when charge rationing is enabled, the ALERT# pin is asserted by default when the current rationing threshold is reached (as determined by RATION_BEH<1:0>). The ALERT# pin is released when all error conditions that may assert the ALERT# pin (such as an error condition and charge rationing) have been removed or reset as necessary.

The UCS2114 is compatible with the Microchip hub devices supporting single pin power control feature. These hub devices have a single connection to the PWR_EN and ALERT# pins of the UCS2114, which are tied together in the application.

5.4.2 BOOST# OUTPUT PIN

The UCS2114 provides a BOOST# output pin to compensate for voltage drops during high loads. The BOOST# pin is an active-low, open-drain output that would be connected to a resistor in the DC-DC converter's feedback error voltage loop (see [Figure 5-3](#)).

The BOOST# pin can then be asserted when the V_{BUS} Current > I_{BOOST}. I_{BOOST} typical value is 1.9A. The BOOST# is OR'ed for both V_{BUS1} and V_{BUS2} ports. When the BOOST# pin is asserted, it will remain in this state for at least t_{BOOST_MAT} (minimum assertion time).

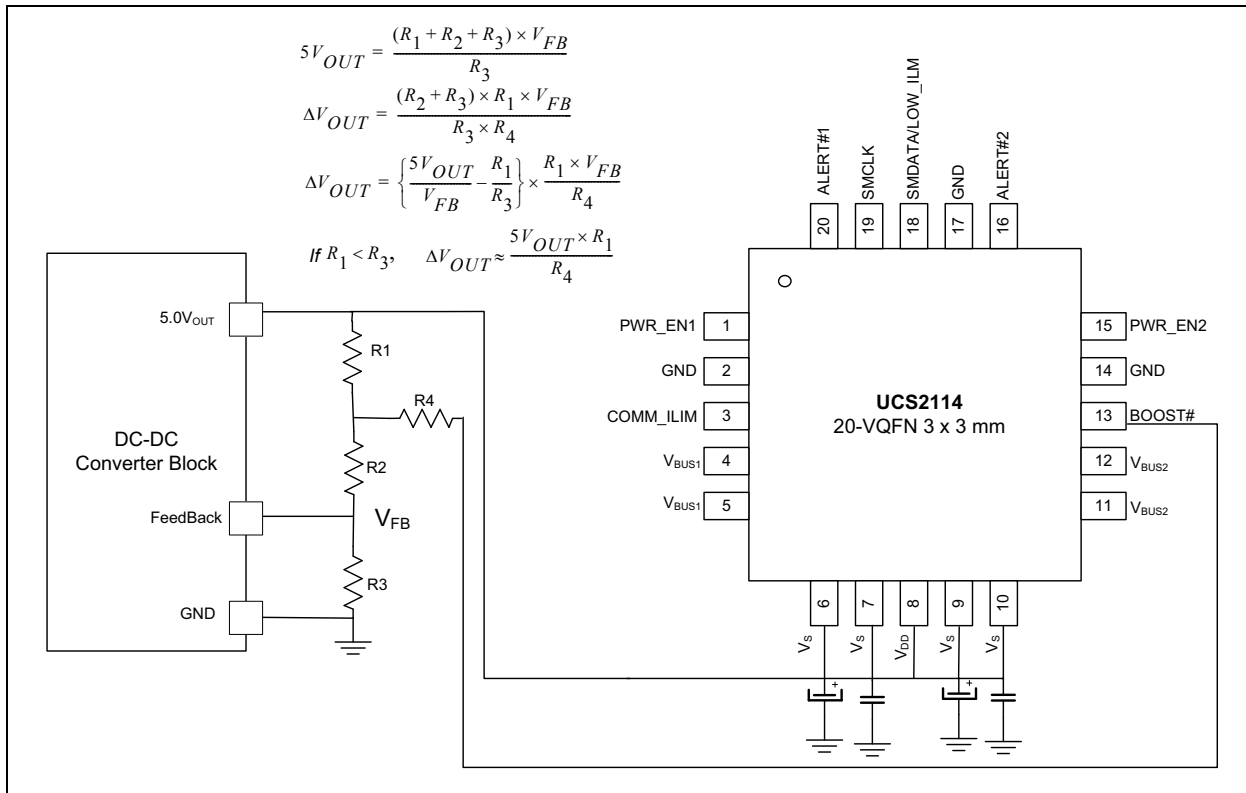

FIGURE 5-3: BOOST# Pin Usage.

5.5 Discrete Input Pins

5.5.1 COMM_ILIM INPUT

The COMM_ILIM input determines the communications mode, as shown in [Table 6-1](#). This is also the hardware strap for MAX Current Limit.

5.5.2 SMCLK

When operated in Stand-Alone mode, this pin should be tied to ground. When the UCS2114 is configured for SMBus communications, the SMCLK is the clock input.

5.5.3 SMDATA

When used in Stand-Alone, this pin should be tied to ground.

When the UCS2114 is configured for SMBus communications, the SMDATA is the data input/output.

6.0 USB PORT POWER SWITCH

To assure compliance to various charging specifications, the UCS2114 contains a USB port power switch that supports two current-limiting modes: Trip and Constant current (variable slope). The current limit (I_{LIM}) is pin selectable (and may be updated via the register set). The switch also includes soft-start circuitry and a separate short-circuit current limit.

The port power switch is on in the Active state (except when V_{BUS} is discharging).

6.1 Current Limiting

6.1.1 CURRENT LIMIT SETTING

The UCS2114 hardware set current limit, I_{LIM} , can be one of eight values. This resistor value is read once upon UCS2114 power-up. The current limit can be changed via the SMBus/I²C after power-up; however, the programmed current limit cannot exceed the hardware set current limit. Unless connected to V_{DD} , the resistors in [Table 6-1](#) are pull-down resistors.

At power-up, the communication mode (Stand-Alone or SMBus/I²C) and hardware current limit (I_{LIM}) are determined via the pull-down resistor (or pull-up resistor if connected to V_{DD}) on the COMM_ILIM pin, as shown in [Table 6-1](#).

6.1.2 SHORT-CIRCUIT OUTPUT CURRENT LIMITING

Short-circuit current limiting occurs when the output current is above the selectable current limit (I_{LIMx}). This event will be detected and the current will immediately be limited (within t_{SHORT_LIM} time). If the condition remains, the port power switch will flag an Error condition and enter the Error state.

6.1.3 SOFT START

When the PWR_EN control changes states to enable the port power switch, the UCS2114 invokes a soft-start routine for the duration of the V_{BUS} rise time (t_{R_BUS}). This soft-start routine will limit current flow from V_S into V_{BUS} while it is active. This circuitry will prevent current spikes due to a step in the portable device current draw.

In the case when a portable device is attached while the PWR_EN pin is already enabled, if the bus current exceeds I_{LIM} , the UCS2114 current limiter will respond within a specified time (t_{SHORT_LIM}) and will operate normally at this point. The C_{BUS} capacitor will deliver the extra current, if any, as required by the load change.

TABLE 6-1: I_{LIM} DECODE

| COMM_ILIM Pulldown Resistor ($\pm 1\%$) | PWR_EN1 and PWR_EN2 Polarity | I_{LIM} (A) | Total I_{LIM} (A) (Note 1) |
|---|------------------------------|---------------|------------------------------|
| GND | Active-High | 0.53 | 0.53+0.53 |
| 10 k Ω | Active-High | 0.96 | 0.96+0.96 |
| 12 k Ω | Active-High | 1.07 | 1.07+1.07 |
| 15 k Ω | Active-High | 1.28 | 1.28+1.28 |
| 18 k Ω | Active-High | 1.6 | 1.6+1.6 |
| 22 k Ω | Active-High | 2.13 | 2.13+2.13 |
| 27 k Ω | Active-High | 2.67 | 2.67+2.67 |
| 33 k Ω | Active-High | 3.2 | 3.2+3.2 |
| 47 k Ω | Active-Low | 0.53 | 0.53+0.53 |
| 56 k Ω | Active-Low | 0.96 | 0.96+0.96 |
| 68 k Ω | Active-Low | 1.07 | 1.07+1.07 |
| 82 k Ω | Active-Low | 1.28 | 1.28+1.28 |
| 100 k Ω | Active-Low | 1.6 | 1.6+1.6 |
| 120 k Ω | Active-Low | 2.13 | 2.13+2.13 |
| 150 k Ω | Active-Low | 2.67 | 2.67+2.67 |
| V_{DD} | Active-Low | 3.2 | 3.2+3.2 |

Note 1: The total maximum current depends on power dissipation characteristics of the design (see [Table 1-1](#)).

6.1.4 CURRENT LIMITING MODES

The UCS2114 current limiting has two modes: Trip and Constant Current (variable slope). Either mode functions at all times when the port power switch is closed.

6.1.4.1 Trip Mode

When using Trip current limiting, the UCS2114 USB port power switch functions as a low-resistance switch and rapidly turns off if the current limit is exceeded. While operating using Trip current limiting, the V_{BUS} output voltage will be held relatively constant (equal to the V_S voltage minus the $R_{ON} \times I_{BUS}$ current) for all current values up to the I_{LIM} .

If the current drawn by a portable device exceeds I_{LIM} , the following occurs:

1. The port power switch will be turned off (Trip action).
2. The UCS2114 will enter the Error state and assert the ALERT# pin.
3. The fault handling circuitry will then determine subsequent actions.

UCS2114

Figure 6-1 shows operation of current limits in Trip mode with the shaded area representing the USB 2.0 specified V_{BUS} range. Dashed lines indicate the port power switch output will go to zero (e.g., Trip) when I_{LIM} is exceeded. Note that operation at all possible values of I_{LIM} is shown in Figure 6-1 for illustrative purposes only; in actual operation, only one I_{LIM} can be active at any time.

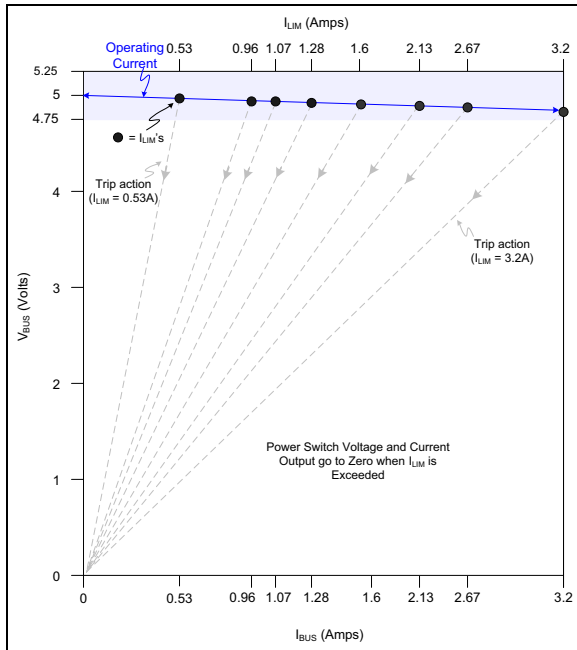

FIGURE 6-1: Current Limiting in Trip Mode.

6.1.4.2 Constant Current Limiting (Variable Slope)

Constant current limiting is used when the current drawn is greater than I_{LIM} (and $I_{LIM} \leq 1.6A$). In CC mode, the port power switch allows the attached portable device to reduce V_{BUS} output voltage to less than the input V_S voltage while maintaining current delivery. The V/I slope depends on the user set I_{LIM} value. This slope is held constant for a given I_{LIM} value.

This mode is specifically provided for devices that rely on resistive means to reduce V_{BUS} voltage for direct battery charging or to allow portable devices a means to “test” charger capacity. See Figure 6-2.

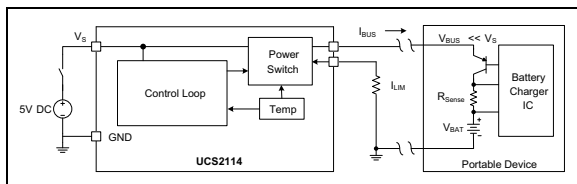

FIGURE 6-2: Constant Current Example.

Figure 6-3 shows operation of current limits while using CC mode. Unlike Trip mode, once I_{BUS} current exceeds I_{LIM} , operation continues at a reduced voltage and increased current. Note that the shaded area representing the USB 2.0 specified V_{BUS} range is now restricted to an upper current limit of I_{BUS_R2MIN} . Note that the UCS2114 will heat up along each load line as voltage decreases. If the internal temperature exceeds the T_{TSD_LOW} threshold, the corresponding power switch operating in constant current mode will open. If the internal temperature exceeds the T_{TSD_HIGH} threshold, both power switches will open, regardless of whether the power switch channels are in current limit. Also note that, when the V_{BUS} voltage is brought low enough (below V_{BUS_MIN}), the port power switch will open.

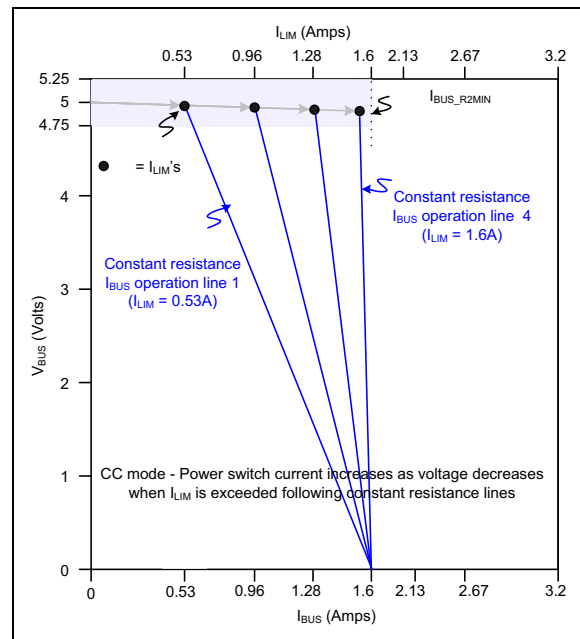

FIGURE 6-3: Current Limiting in CC Mode.

6.2 USB Port Power Profiles

The UCS2114 combines the qualities of traditional USB port power switches with USB port power profiles set forth in the USB-IF BC1.2 specification. USB port power profiles consist of distinct voltage-current operation regions defined by “keep-out” and “operation” regions.

While operating in the CC mode of operation, the UCS2114 provides voltage-current output operating profiles that are specified by two keep-out regions.

If the current reaches the I_{BUS_R2MIN} setting for longer than t_{MASK} , the UCS2114 enters the Error state and an Overcurrent event is flagged.

If the V_{BUS} voltage ever goes below the no-operation lower-voltage keep-out (V_{BUS_MIN}) value for longer than t_{MASK} , the port power switch is disabled and a keep-out violation is flagged (by setting the MIN_KEEP_OUT status bit). This will cause the device to enter the Error state.

Figure 6-4 illustrates the relationship between these USB port power profile parameters.

6.2.1 OPERATION WITHIN A USB PORT POWER PROFILE

An attached device may be constrained to operate within the boundaries of a USB port power profile by setting the value of I_{LIM} less than the USB port power profile I_{BUS_R2MIN} value. In this case, the port power switch will be in Trip mode up until I_{LIM} is exceeded, at which point, the switch will transition into CC mode. If the attached device reduces the output voltage to less than V_{BUS_MIN} , the switch will trip and terminate charging.

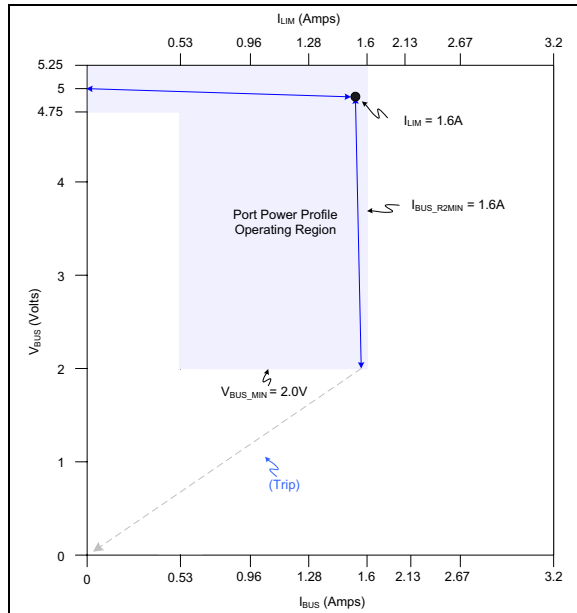

FIGURE 6-4: $I_{LIM} < I_{BUS_R2MIN}$ Example.

Note: The CC mode of operation is possible only up to 1.6A. As long as the value of I_{LIM} is less than the fixed port power profile I_{BUS_R2MIN} value, CC mode is possible. Otherwise, the USB port power switch will operate in Trip mode operation.

6.2.2 OPERATION OUTSIDE OF A USB PORT POWER PROFILE

An attached device may be allowed to operate outside of the boundaries of a USB port power profile by setting the value of I_{LIM} greater than the USB port power profile I_{BUS_R2MIN} value. This is the default operation for all portable devices. In this case, the USB port power switch will operate in Trip mode until the bus current reaches the I_{LIM} value. Once the I_{LIM} value has been exceeded, the port power switch will open and terminate charging. Figure 6-5 illustrates an example of current limiting in this configuration.

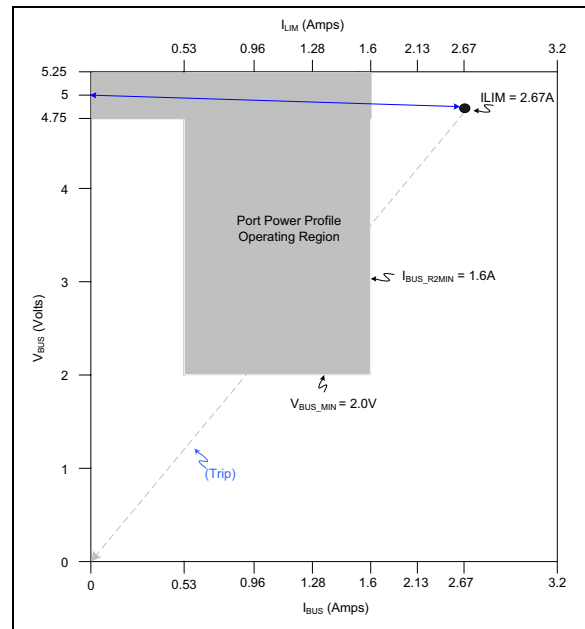

FIGURE 6-5: $I_{LIM} > I_{BUS_R2MIN}$ Example.

6.3 Thermal Protection

The UCS2114 utilizes two-stage internal thermal management. The first is triggered when the die temperature exceeds T_{TSD_LOW} threshold, and the second is triggered when the die temperature exceeds T_{TSD_HIGH} threshold.

6.3.0.1 THE FIRST THERMAL SHUTDOWN STAGE (T_{TSD_LOW})

The first stage turns off the individual power switch channel when the die temperature exceeds T_{TSD_LOW} threshold and a power switch operates in Constant Current mode. It also causes the corresponding channel to enter in error state and the corresponding ALERT# pin to be asserted.

When an overcurrent condition appears, the power switch operates in Constant Current mode for the duration of t_{MASK} time. Because of the increased voltage drop across the switch, the die temperature increases. If the die temperature exceeds T_{TSD_LOW} threshold before the expiration of the t_{MASK} time, then the power switch will open immediately.

If the T_{TSD_LOW} threshold has been exceeded, but the die temperature has not decreased below the T_{TSD_LOW} recovery threshold, then the power switch cannot be closed when commanded by the PWR_EN1 or PWR_EN2 controls in the following situations:

- PWR_EN1 and/or PWR_EN2 controls transition from inactive to active.
- it is a power-up situation and PWR_EN1 and/or PWR_EN2 pins are active.

In these situations, the corresponding channel will enter in error state and the corresponding ALERT# pin will be asserted.

The first thermal shutdown stage allows the two ports to work independently, by preventing the die temperature to increase during overcurrent conditions and to exceed the maximum allowable temperature (T_{TSD_HIGH}).

The error state will persist and the power switches cannot be closed until the temperature is below $T_{TSD_LOW} - T_{TSD_LOW_HYST}$.

6.3.0.2 THE SECOND THERMAL SHUTDOWN STAGE (T_{TSD_HIGH})

The second thermal protection stage turns off both power switches when the die temperature exceeds T_{TSD_HIGH} threshold, regardless of whether the power switch channels are in current limit. It also causes both channels to enter in error state and both ALERT#1 and ALERT#2 pins to be asserted.

The error state will persist and the power switches cannot be closed until the temperature is below $T_{TSD_HIGH} - T_{TSD_HIGH_HYST}$.

6.4 V_{BUS} Discharge

When the EN_VBUS_DISCHG bit from General Configuration 2 register is set (by default it is not set), the UCS2114 will discharge V_{BUS} through an internal 100Ω resistor when at least one of the following conditions occur:

- The PWR_EN control is disabled (triggered on the inactive edge of the PWR_EN control).
- The V_S voltage drops below a specified threshold (V_{S_UVLO}) that causes the port power switch to be disabled.
- When commanded into the Sleep power state.
- Upon recovery from the Error state.
- When commanded via the SMBus in the Active state.

When the automatic V_{BUS} discharge circuitry is activated, the UCS2114 will confirm that V_{BUS} was discharged at the end of the $t_{DISCHARGE}$ time. If the V_{BUS} voltage is not below the V_{TEST} level, a discharge error will be flagged (by setting the DISCH_ERR(1/2) status bit) and the UCS2114 will enter the Error state.

When the EN_VBUS_DISCHG bit from General Configuration 2 register is not set (default setting), the automatic V_{BUS} discharges described above are disabled. In this case, the SMBus master must set and clear bits DISCHG_LOAD1 and DISCHG_LOAD2 from the Current Limit Behavior registers, to discharge the V_{BUS1} and V_{BUS2} . Setting the DISCHG_LOAD1 and DISCHG_LOAD2 bits connects the internal 100Ω resistor to discharge the corresponding V_{BUS} path. This functionality doesn't use any timers. The discharge time is controlled by the SMBus master, which must clear this bit when its internal timer expires.

6.5 Charge Rationing Interactions

When charge rationing is active, regardless of the specified behavior, the UCS2114 will function normally until the charge rationing threshold is reached. Note that charge rationing is only active when the UCS2114 is in the Active state. Changing the charge rationing behavior will have no effect on the charge rationing data registers. If the behavior is changed prior to reaching the charge rationing threshold, this change

will occur and be transparent to the user. When the charge rationing threshold is reached, the UCS2114 will take action as shown in [Table 6-2](#). If the behavior is changed after the charge rationing threshold has been reached, the UCS2114 will immediately adopt the newly programmed behavior, clearing the ALERT# pin and restoring switch operation respectively (see [Table 6-4](#)).

TABLE 6-2: CHARGE RATIONING BEHAVIOR

| RATION_BEH (1 or 2) <1:0> | | Behavior | Actions Taken | Notes |
|------------------------------|---|---------------------------------|---|--|
| 1 | 0 | | | |
| 0 | 0 | Report | ALERT# pin asserted. | |
| 0 | 1 | Report and Disconnect (default) | <ol style="list-style-type: none"> ALERT# pin asserted. Port power switch disconnected. | All bus monitoring is still active. Toggling the PWR_EN control will cause the device to change power states as defined by the registers; however, the port power switch will remain off until the rationing circuitry is reset. |
| 1 | 0 | Disconnect and Go to Sleep | <ol style="list-style-type: none"> Port power switch disconnected. Device will enter the Sleep state. | All V _{BUS} and V _S monitoring will be stopped. Toggling the PWR_EN control will have no effect on the power state until the rationing circuitry is reset. |
| 1 | 1 | Ignore | Take no further action. | |

TABLE 6-3: CHARGE RATIONING RESET BEHAVIOR

| Behavior | Reset Actions |
|----------------------------|--|
| Report | <ol style="list-style-type: none"> Reset the Total Accumulated Charge registers. Clear the RATION status bit. Release the ALERT# pin. |
| Report and Disconnect | <ol style="list-style-type: none"> Reset the Total Accumulated Charge registers. Clear the RATION status bit. Release the ALERT# pin. Check the PWR_EN controls and enter the indicated power state if the controls changed. |
| Disconnect and Go to Sleep | <ol style="list-style-type: none"> Reset the Total Accumulated Charge registers. Clear the RATION status bit. Check the PWR_EN controls and enter the indicated power state if the controls changed. |
| Ignore | <ol style="list-style-type: none"> Reset the Total Accumulated Charge registers. Clear the RATION status bit. |

TABLE 6-4: EFFECTS OF CHANGING RATIONING BEHAVIOR AFTER THRESHOLD REACHED

| Previous Behavior | New Behavior | Actions Taken |
|----------------------------|----------------------------|--|
| Ignore | Report | Assert ALERT# pin |
| | Report and Disconnect | <ol style="list-style-type: none"> 1. Assert ALERT# pin. 2. Open port power switch. See the Report and Disconnect (default) in Table 6-2. |
| | Disconnect and Go to Sleep | <ol style="list-style-type: none"> 1. Open port power switch. 2. Enter the Sleep state. See the Disconnect and Go to Sleep in Table 6-2. |
| Report | Ignore | Release ALERT# pin. |
| | Report and Disconnect | Open port power switch. See the Report and Disconnect (default) in Table 6-2 . |
| | Disconnect and Go to Sleep | <ol style="list-style-type: none"> 1. Release the ALERT# pin. 2. Open the port power switch. 3. Enter the Sleep state. See the Disconnect and Go to Sleep in Table 6-2. |
| Report and Disconnect | Ignore | <ol style="list-style-type: none"> 1. Release the ALERT# pin. 2. Check the PWR_EN controls and enter the indicated power state if the controls changed. |
| | Report | Check the PWR_EN controls and enter the indicated power state if the controls changed. |
| | Disconnect and Go to Sleep | <ol style="list-style-type: none"> 1. Release the ALERT# pin. 2. Enter the Sleep state. See the Disconnect and Go to Sleep in Table 6-2. |
| Disconnect and Go to Sleep | Ignore | Check the PWR_EN controls and enter the indicated power state if the controls changed. |
| | Report | <ol style="list-style-type: none"> 1. Assert the ALERT# pin. 2. Check the PWR_EN controls and enter the indicated power state if the controls changed. |
| | Report and Disconnect | <ol style="list-style-type: none"> 1. Assert the ALERT# pin. 2. Check the PWR_EN controls to determine the power state, then enter that state, except that the port power switch will not be closed. |

If the RATION_EN control is set to '0' prior to reaching the charge rationing threshold, rationing will be disabled and the Total Accumulated Charge registers will be cleared. If the RATION_EN control is set to '0' after the charge rationing threshold has been reached, the following additional steps occur:

1. RATION status bit will be cleared.
2. The ALERT# pin will be released if asserted by the rationing circuitry and no other conditions are present.
3. The PWR_EN controls are checked to determine the power state.

Setting the RATION_RST control to '1' will automatically reset the Total Accumulated Charge registers to 00_00h. If this is done prior to reaching the charge rationing threshold, the data will continue to be accumulated restarting from 00_00h. If this is done after the charge rationing threshold is reached, the UCS2114 will take action as shown in [Table 6-3](#).

6.6 Fault Handling Mechanism

The UCS2114 has two modes for handling faults:

- Latch (latch-upon-fault)
- Auto-recovery (automatically attempt to restore the Active power state after a fault occurs).

If the SMBus is actively utilized, Auto-Recovery Fault Handling is the default error handler as determined by the LATCH_SET bit. Faults include overcurrent, overvoltage (on V_S), undervoltage (on V_{BUS}), back-voltage (V_{BUS} to V_S or V_{BUS} to V_{DD}), discharge error and maximum allowable internal die temperature (T_{TSD_HIGH}) exceeded. Fault conditions also include the situations when T_{TSD_LOW} die temperature has been exceeded and any of the following conditions are met:

- a power switch operates in Constant Current mode.
- PWR_EN1 and/or PWR_EN2 controls transition from inactive to active.
- it is a power-up situation and PWR_EN1 and/or PWR_EN2 pins are active.

Faults do not include:

- keep-out violations except V_{BUS_MIN} .
- T_{TSD_LOW} die temperature has been exceeded and any of the following conditions are met:
 - the power switch is closed at the time when T_{TSD_LOW} is reached and it is not in Constant Current mode.
 - the power switch remains open (PWR_EN1 and/or PWR_EN2 controls are not active).

6.6.1 AUTO-RECOVERY FAULT HANDLING

When the LATCH_SET bit is low, Auto-Recovery Fault Handling is used. When an error condition is detected, the UCS2114 will immediately enter the Error state and assert the ALERT# pin. Independently from the host controller, the UCS2114 will wait a preset time (t_{CYCLE}), check error conditions (t_{TST}) and restore Active operation if the error condition(s) no longer exist. If all other conditions that may cause the ALERT# pin to be asserted have been removed, the ALERT# pin will be released. Short-Circuit Auto-Recovery example in [Figure 6-6](#).

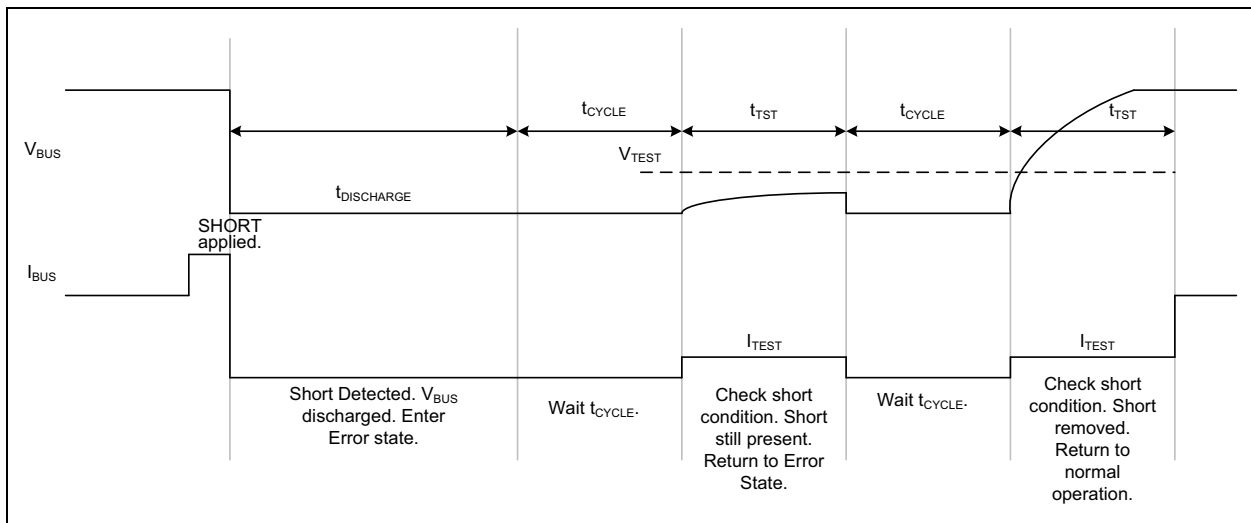

FIGURE 6-6: Error Recovery.

6.6.2 LATCHED FAULT HANDLING

When the LATCH_SET bit is high, latch fault handling is used. When an error condition is detected, the UCS2114 will enter the Error power state and assert the ALERT# (1 or 2) pin. Upon command from the host controller (by toggling the PWR_EN (1, or 2) pin control from enabled to disabled or by clearing the ERR bit via SMBus), the UCS2114 will check error conditions once and restore Active operation if error conditions no longer exist. If an error condition still exists, the host controller is required to issue the command again to check error conditions.

If the ALERT# pin is asserted and the interrupt status registers (addresses 03h or 04h) are not read, the corresponding ALERT# pin remains asserted until the corresponding PWR_EN pin is toggled.

If the ALERT# pin is asserted and the interrupt status registers are read, the ALERT# pin will deassert, but the UCS will remain in error state until the ERR bit is cleared via SMBus or the PWR_EN pin is toggled.

UCS2114

NOTES:

7.0 SYSTEM MANAGEMENT BUS PROTOCOL

In SMBus mode, the UCS2114 communicates with a host controller, such as a Microchip PIC[®] microcontroller or hub, through the SMBus. The SMBus is a two-wire serial communication protocol between a computer host and its peripheral devices. A detailed timing diagram is shown in [Figure 1-1](#). Stretching of the SMCLK signal is supported; however, the UCS2114 will not stretch the clock signal.

7.1 SMBus Start Bit

The SMBus Start bit is defined as a transition of the SMBus Data line from a logic '1' state to a logic '0' state while the SMBus Clock line is in a logic '1' state.

7.2 SMBus Address and RD/WR Bit

The SMBus Address Byte consists of the 7-bit client address followed by the RD/WR indicator bit. If this RD/WR bit is a logic '0', the SMBus Host is writing data to the client device. If this RD/WR bit is a logic '1', the SMBus Host is reading data from the client device.

The UCS2114 with the order code UCS2114-1-V/LX has the SMBus address 57h - 1010_111 (r/w).

Customers should contact their distributor, representatives or field application engineer (FAE) for additional SMBus addresses. Local sales offices are also available to help customers. A list of sales offices and locations is included in the back of this document.

7.3 SMBus Data Bytes

All SMBus Data bytes are sent most significant bit first and composed of 8 bits of information.

7.4 SMBus ACK and NACK Bits

The SMBus client will acknowledge all data bytes that it receives. This is done by the client device pulling the SMBus Data line low after the 8th bit of each byte that is transmitted. This applies to both the Write Byte and Block Write protocols.

The Host will NACK (not acknowledge) the last data byte to be received from the client by holding the SMBus data line high after the 8th data bit has been sent. For the Block Read protocol, the Host will ACK (acknowledge) each data byte that it receives except the last data byte.

7.5 SMBus Stop Bit

The SMBus Stop bit is defined as a transition of the SMBus Data line from a logic '0' state to a logic '1' state while the SMBus clock line is in a logic '1' state. When the UCS2114 detects an SMBus Stop bit and it has been communicating with the SMBus protocol, it will reset its client interface and prepare to receive further communications.

7.6 SMBus Time-out

The UCS2114 includes an SMBus time-out feature. If the clock is held at logic '0' for $t_{TIMEOUT}$, the device can time out and reset the SMBus interface. The SMBus interface can also reset if both the clock and data lines are held at a logic '1' for t_{IDLE_RESET} . Communication is restored with a start condition.

The time-out function defaults to disabled. It can be enabled by clearing the DIS_TO bit in the General Configuration 3 register (see [Register 8-9](#)).

7.7 SMBus and I²C Compliance

The major difference between SMBus and I²C devices is highlighted here. For complete compliance information, refer to the SMBus 2.0 specification and Application Note 14.0.

- UCS2114 supports I²C fast mode at 400 kHz. This covers the SMBus maximum time of 100 kHz.
- The minimum frequency for SMBus communications is 10 kHz.
- The client protocol will reset if the clock is held low longer than 30 ms. This time out functionality is disabled by default in the UCS2114 and can be enabled by clearing the DIS_TO bit. I²C does not have a time out.
- Except when operating in Sleep, the client protocol will reset if both the clock and the data line are logic '1' for longer than 200 μ s (idle condition). This function is disabled by default in the UCS2114 and can be enabled by clearing the DIS_TO bit. I²C does not have an idle condition.
- I²C devices do not support the Alert Response Address functionality (which is optional for SMBus).
- I²C devices support block read and write differently. I²C protocol allows for unlimited number of bytes to be sent in either direction. The SMBus protocol requires that an additional data byte indicating number of bytes to read/write is transmitted. The UCS2114 supports I²C formatting only.

7.8 SMBus Protocols

The UCS2114 device is SMBus 2.0-compatible and supports Send Byte, Read Byte, Block Read, Receive Byte as valid protocols, as shown below. The UCS2114 device also supports the I²C block read and block write protocols. The device supports Write Byte, Read Byte and Block Read/Block Write. All of the below protocols use the convention in [Table 7-1](#).

TABLE 7-1: SMBUS PROTOCOL

| Data Sent to Device | Data Sent to the Host |
|---------------------|-----------------------|
| Data sent | Data sent |

UCS2114

7.9 SMBus Write Byte

The Write Byte is used to write one byte of data to a specific register as shown in [Table 7-2](#).

TABLE 7-2: WRITE BYTE PROTOCOL

| START | Slave Address | WR | ACK | Reg. Addr. | ACK | Register Data | ACK | STOP |
|-------|---------------|----|-----|------------|-----|---------------|-----|-------|
| 1 → 0 | YYYY_YYY | 0 | 0 | XXh | 0 | XXh | 0 | 0 → 1 |

7.10 SMBus Read Byte

The Read Byte protocol is used to read one byte of data from the registers as shown in [Table 7-3](#).

TABLE 7-3: READ BYTE PROTOCOL

| START | Slave Address | WR | ACK | Register Address | ACK | |
|-------|---------------|----|-----|------------------|------|-------|
| 1 → 0 | YYYY_YYY | 0 | 0 | XXh | 0 | |
| START | Slave Address | RD | ACK | Register Data | NACK | STOP |
| 1 → 0 | YYYY_YYY | 1 | 0 | XXh | 1 | 0 → 1 |

7.11 Block Write

The Block Write is used to write multiple data bytes to a group of contiguous registers, as shown in [Table 7-4](#). It is an extension of the Write Byte Protocol.

Note: The Block Write and Block Read protocols require that the address pointer be automatically incremented. For a write command, the address pointer will be automatically incremented when the ACK is sent to the host. There are no over or under bound limit checking and the address pointer will wrap around from FFh to 00h if necessary

TABLE 7-4: BLOCK WRITE PROTOCOL

| START | Slave Address | WR | ACK | Register Address | ACK | Repeat N Times | | STOP |
|-------|---------------|----|-----|------------------|-----|----------------|-----|-------|
| | | | | | | Register Data | ACK | |
| 1 → 0 | YYYY_YYY | 0 | 0 | XXh | 0 | XXh | 0 | 0 → 1 |

7.12 Block Read

The Block Read is used to read multiple data bytes from a group of contiguous registers, as shown in [Table 7-5](#). It is an extension of the Read Byte Protocol.

TABLE 7-5: BLOCK READ PROTOCOL

| START | Slave Address | WR | ACK | Register Address | ACK | | | |
|-------|---------------|----|-----|------------------|-----|---------------|------|-------|
| 1 → 0 | YYYY_YYY | 0 | 0 | XXh | 0 | | | |
| START | Slave Address | RD | ACK | Repeat N Times | | Register Data | NACK | STOP |
| | | | | Register Data | ACK | | | |
| 1 → 0 | YYYY_YYY | 1 | 0 | XXh | 0 | XXh | 1 | 0 → 1 |

7.13 SMBus Send Byte

The Send Byte protocol is used to set the internal address register pointer to the correct address location. No data is transferred during the Send Byte protocol as shown in [Table 7-6](#).

Note: The SMBus Send Byte command is expected to be followed by the SMBus Receive Byte command. When two SMBus Send Byte commands are sent in a row, the first command receives an ACK and will be processed by the UCS2114, but the second command receives a NACK and will be ignored.

TABLE 7-6: SEND BYTE PROTOCOL

| START | Slave Address | WR | ACK | Register Address | ACK | STOP |
|-------|---------------|----|-----|------------------|-----|-------|
| 1→0 | YYYY_YYY | 0 | 0 | XXh | 0 | 0 → 1 |

7.14 SMBus Receive Byte

The Receive Byte protocol is used to read data from a register when the internal register address pointer is known to be at the right location (e.g., set via Send Byte). This is used for consecutive reads of the same register as shown in [Table 7-7](#).

TABLE 7-7: RECEIVE BYTE PROTOCOL

| START | Slave Address | RD | ACK | Register Data | NACK | STOP |
|-------|---------------|----|-----|---------------|------|-------|
| 1→0 | YYYY_YYY | 1 | 0 | XXh | 1 | 0 → 1 |

7.14.1 STAND-ALONE OPERATING MODE

Stand-Alone mode allows the UCS2114 to operate without active SMBus/I²C communications. Stand-Alone mode can be enabled by connecting a pull-down resistor greater or equal to 47 kΩ on the COMM_ILIM pin as shown in [Table 5-3](#). The SMCLK pin should be tied to ground in this mode.

UCS2114

NOTES:

8.0 REGISTER DESCRIPTION

The registers shown in [Table 8-1](#) are accessible through the SMBus or I²C. An entry of ‘—’ indicates that the bit is not used. Writing to these bits will have no effect and reading these bits will return ‘0’. Writing to a reserved bit may cause unexpected results and reading from a reserved bit will return either ‘1’ or ‘0’ as indicated in the bit description. While in the Sleep state, the UCS2114 will retain configuration and charge rationing data as indicated in the text. If a register does not indicate that data will be retained in the Sleep power state, this information will be lost when the UCS2114 enters the Sleep power state.

TABLE 8-1: REGISTER SET IN HEXADECIMAL ORDER

| Register Address | Register Name | R/W | Function | Default Value | Page No. |
|------------------|--|----------|--|---------------|--------------------|
| 00h | Port 2 Current Measurement | R | Stores the current measurement for Port 2 | 00h | 38 |
| 01h | Port 1 Current Measurement | R | Stores the current measurement for Port 1 | 00h | 38 |
| 02h | Port Status | R | Indicates Port and general status | 00h | 39 |
| 03h | Interrupt Status2 | See Text | Indicates why ALERT# pin asserted for Port 2 | 00h | 40 |
| 04h | Interrupt Status1 | See Text | Indicates why ALERT# pin asserted for Port 1 | 00h | 42 |
| 0Fh | General Status2 | R/R-C | Indicates General Status for Port 2 | 00h | 44 |
| 10h | General Status1 | R/R-C | Indicates General Status for Port 1 | 00h | 45 |
| 11h | General Configuration2 | R/W | Controls basic functionality for Port 2 | 06h | 46 |
| 12h | General Configuration1 | R/W | Controls basic functionality for Port 1 | 02h | 47 |
| 13h | General Configuration3 | R/W | Controls other functionality | 60h | 48 |
| 14h | Current Limit | R/W | Controls/Displays MAX Current Limit per port | 00h | 49 |
| 15h | Auto-Recovery Configuration | R/W | Controls the Auto-Recovery functionality | 2Ah | 50 |
| 16h | Port 2 Total Accumulated Charge High Byte | R | Stores the total accumulated charge delivered high byte, Port 2 | 00h | 51 |
| 17h | Port 2 Total Accumulated Charge Middle High Byte | R | Stores the total accumulated charge delivered middle high byte, Port 2 | 00h | 51 |
| 18h | Port 2 Total Accumulated Charge Middle Low Byte | R | Stores the total accumulated charge delivered middle low byte, Port 2 | 00h | 51 |
| 19h | Port 2 Total Accumulated Charge Low Byte | R | Stores the total accumulated charge delivered low byte, Port 2 | 00h | 51 |
| 1Ah | Port 1 Total Accumulated Charge High Byte | R | Stores the total accumulated charge delivered high byte, Port 1 | 00h | 52 |
| 1Bh | Port 1 Total Accumulated Charge Middle High Byte | R | Stores the total accumulated charge delivered middle high byte, Port 1 | 00h | 52 |
| 1Ch | Port 1 Total Accumulated Charge Middle Low Byte | R | Stores the total accumulated charge delivered middle low byte, Port 1 | 00h | 52 |
| 1Dh | Port 1 Total Accumulated Charge Low Byte | R | Stores the total accumulated charge delivered low byte, Port 1 | 00h | 52 |
| 1Eh | Port 2 Charge Rationing Threshold High Byte | R/W | Sets the maximum allowed charge that will be delivered to Port 2 | FFh | 53 |
| 1Fh | Port 2 Charge Rationing Threshold Low Byte | R/W | Sets the maximum allowed charge that will be delivered to Port 2 | FFh | 53 |
| 20h | Port 1 Charge Rationing Threshold High Byte | R/W | Sets the maximum allowed charge that will be delivered to Port 1 | FFh | 53 |

TABLE 8-1: REGISTER SET IN HEXADECIMAL ORDER (CONTINUED)

| Register Address | Register Name | R/W | Function | Default Value | Page No. |
|------------------|--|-----|--|---------------|----------|
| 21h | Port 1 Charge Rationing Threshold Low Byte | R/W | Sets the maximum allowed charge that will be delivered to Port 1 | FFh | 53 |
| 22h | Ration Configuration | R/W | Controls Charge Ration Functionality | 11h | 54 |
| 23h | Port 2 Current Limit Behavior | R/W | Controls the Current Limiting Behavior (CC Mode Region 2) for Port 2 | 96h | 55 |
| 24h | Port 1 Current Limit Behavior | R/W | Controls the Current Limiting Behavior (CC Mode Region 2) for Port 1 | 96h | 56 |
| FDh | Product ID | R | Stores a fixed value that identifies each product | E3h | 57 |
| FEh | Manufacturer ID | R | Stores a fixed value that identifies Microchip | 5Dh | 57 |
| FFh | Revision | R | Stores a fixed value that represents the revision number | 81h | 57 |

8.1 Current Measurement Register

The Current Measurement register stores the measured current value delivered to the portable device (I_{BUS}). This value is updated continuously while the device is in the Active power state.

REGISTER 8-1: PORTS 2 AND 1 CURRENT MEASUREMENT REGISTERS (ADDRESSES 00H AND 01H)

| | | | | | | | |
|------------|-----|-----|-----|-----|-----|-----|-------|
| R-0 | R-0 | R-0 | R-0 | R-0 | R-0 | R-0 | R-0 |
| CM(x)<7:0> | | | | | | | |
| bit 7 | | | | | | | bit 0 |

Legend:

R = Readable bit W = Writable bit U = Unimplemented bit
 -n = Value at POR '1' = Bit is set '0' = Bit is cleared x = Bit is unknown

bit 7-0 **CM(x)<7:0>**: Port X Current Measurement, where x = 2 or 1 (address 00h for Port 2 and address 01h for Port 1).

- Note 1:** The bit weights are in mA, 1 LSB = 13.3 mA (maximum value is 255 LSB corresponding to 3.4A).
2: This data will be cleared when the device enters the Sleep state. This data will also be cleared whenever the port power switch is turned off (or any time that V_{BUS} is discharged).

8.2 Status Registers

The Status registers store bits that indicate the state of the ALERT# pins and if the ports operate in Constant Current mode.

REGISTER 8-2: PORT STATUS REGISTER (ADDRESS 02H)

| | | | | | | | |
|------------|------------|----------|----------|-----|-----|-----|-------|
| R-0 | R-0 | R-0 | R-0 | U-0 | U-0 | R-x | R-x |
| ALERT1_PIN | ALERT2_PIN | CC_MODE1 | CC_MODE2 | — | — | — | — |
| bit 7 | | | | | | | bit 0 |

Legend:

| | | |
|-------------------|------------------|--|
| R = Readable bit | W = Writable bit | U = Unimplemented bit |
| -n = Value at POR | '1' = Bit is set | '0' = Bit is cleared x = Bit is unknown |

- bit 7 **ALERT1_PIN:** Reflects the status of the ALERT#1 pin. This bit is set and cleared as the ALERT#1 pin changes states.
 1 = ALERT#1 Pin asserted (logic low)
 0 = ALERT#1 Pin not asserted
- bit 6 **ALERT2_PIN:** Reflects the status of the ALERT#2 pin. This bit is set and cleared as the ALERT#2 pin changes states.
 1 = ALERT#2 Pin asserted (logic low)
 0 = ALERT#2 Pin not asserted
- bit 5 **CC_MODE1:** Port 1 Constant Current mode state
 1 = Port 1 in Constant Current mode
 0 = Port 1 operating normally
- bit 4 **CC_MODE2:** Port 2 Constant Current mode state
 1 = Port 2 in Constant Current mode
 0 = Port 2 operating normally
- bit 3-0 **Unimplemented**

UCS2114

REGISTER 8-3: INTERRUPT STATUS 2 REGISTER (ADDRESS 03H)

| R/W-0 | R/C-0 | R/C-0 | R/C-0 | R/C-0 | R/C-0 | R/C-0 | R/C-0 |
|-------|------------|-------|-----------|----------|---------|---------|---------|
| ERR2 | DISCH_ERR2 | RESET | KEEP_OUT2 | TSD_HIGH | OV_VOLT | BACK_V2 | OV_LIM2 |
| bit 7 | | | | | | | bit 0 |

Legend:

| | | | |
|-------------------|------------------|-----------------------|--------------------|
| R = Readable bit | W = Writable bit | U = Unimplemented bit | C = Clear on Read |
| -n = Value at POR | '1' = Bit is set | '0' = Bit is cleared | x = Bit is unknown |

bit 7 **ERR2:** Error Port 2 - Indicates that an error was detected on the V_{BUS2} pin and the device has entered the Error state. Writing this bit to '0' will clear the Error state and allows the device to be returned to the Active state. When written to '0', all error conditions are checked. If all error conditions have been removed, the UCS2114 returns to the Active state. This bit is set automatically by the UCS2114 when the Error state is entered. If any other bit is set in the Interrupt Status 2 register (03h), the device will not leave the Error state.

This bit is cleared automatically by the UCS2114 if the Auto-recovery fault handling functionality is active and no error conditions are detected. Likewise, this bit is cleared when the PWR_EN2 control is disabled ([Note 1](#)).

- 1 = Port 2 in Error state
- 0 = Port 2 in Active state (no errors detected)

bit 6 **DISCH_ERR2:** Discharge Error Port 2 - Indicates the device was unable to discharge Port2. This bit will be cleared when read if the error condition has been removed or if the ERR2 bit is cleared. This bit will cause the ALERT#2 pin to be asserted and the device to enter the Error state.

- 1 = UCS2114 was unable to Discharge V_{BUS2}
- 0 = No V_{BUS2} discharge error

bit 5 **RESET:** Indicates that the UCS2114 has just been reset and should be reprogrammed. This bit will be set at power-up. This bit is cleared when read or when the PWR_EN control is toggled. The ALERT# pins are not asserted when this bit is set. This data is retained in the Sleep state.

- 1 = UCS2114 has just been reset
- 0 = Reset did not occur

bit 4 **KEEP_OUT2:** Port 2 Minimum Keep-Out region - Indicates that the V-I output on the V_{BUS2} pin has dropped below V_{BUS_MIN} . This bit will be cleared when read if the error condition has been removed or if the ERR2 bit is cleared. This bit will cause the ALERT#2 pin to be asserted and the device to enter the Error state.

- 1 = $V_{BUS2} < V_{BUS_MIN}$
- 0 = $V_{BUS2} > V_{BUS_MIN}$

bit 3 **TSD_HIGH:** Indicates that the internal temperature has exceeded T_{TSD_HIGH} threshold and the device has entered the Error state. This bit will be cleared when read if the error condition has been removed or if the ERR2 bit is cleared. This bit will cause the ALERT#1 and ALERT#2 pins to be asserted and the device to enter the Error state.

- 1 = Internal die temperature has exceeded T_{TSD_HIGH}
- 0 = Internal die temperature has not exceeded T_{TSD_HIGH}

bit 2 **OV_VOLT:** V_S Overvoltage indicates that the V_S voltage has exceeded the V_{S_OV} threshold and the device has entered the Error state. This bit will be cleared when read if the error condition has been removed or if the ERR2 bit is cleared. This bit will cause the ALERT#1 and ALERT#2 pins to be asserted and the device to enter the Error state.

- 1 = $V_S > V_{S_OV}$
- 0 = $V_S < V_{S_OV}$

REGISTER 8-3: INTERRUPT STATUS 2 REGISTER (ADDRESS 03H) (CONTINUED)

- bit 1 **BACK_V2:** Back-Bias Voltage Port 2 - Indicates that the V_{BUS2} voltage has exceeded the V_S or V_{DD} voltages by more than 150 mV. This bit will be cleared when read if the error condition has been removed or if the ERR2 bit is cleared. This bit will cause the ALERT#2 pin to be asserted and the device to enter the Error state.
- 1 = $V_{BUS2} > V_S$, or $V_{BUS1} > V_{DD}$ by more than 150 mV.
 - 0 = V_{BUS2} voltage has not exceeded the V_S and V_{DD} voltages by more than 150 mV.
- bit 0 **OV_LIM2:** Overcurrent Limit Port 2 - Indicates that the I_{BUS} current has exceeded both the I_{LIM} threshold and the I_{BUS_R2MIN} threshold settings for V_{BUS2} . This bit will be cleared when read if the error condition has been removed or if the ERR2 bit is cleared. This bit will cause the ALERT#2 pin to be asserted and the device to enter the Error state.
- 1 = Current Limit for Port 2 exceeded
 - 0 = Current Limit for Port 2 not exceeded

Note 1: Note that the ERR2 bit does not necessarily reflect the ALERT#2 pin status. The ALERT#2 pin may be cleared or asserted without the ERR2 bit changing states.

UCS2114

REGISTER 8-4: INTERRUPT STATUS 1 REGISTER (ADDRESS 04H)

| R/W-0 | R/C-0 | R-0 | R/C-0 | R/C-0 | U-0 | R/C-0 | R/C-0 |
|-------|------------|--------|-----------|---------|-----|---------|---------|
| ERR1 | DISCH_ERR1 | VS_LOW | KEEP_OUT1 | TSD_LOW | — | BACK_V1 | OV_LIM1 |
| bit 7 | | | | | | bit 0 | |

Legend:

| | | | |
|-------------------|------------------|-----------------------|--------------------|
| R = Readable bit | W = Writable bit | U = Unimplemented bit | C = Clear on Read |
| -n = Value at POR | '1' = Bit is set | '0' = Bit is cleared | x = Bit is unknown |

- bit 7 **ERR1:** Error Port 1 - Indicates that an error was detected on the V_{BUS1} pin and the device has entered the Error state. Writing this bit to a '0' will clear the Error state and allows the device to be returned to the Active state. When written to '0', all error conditions are checked. If all error conditions have been removed, the UCS2114 returns to the Active state. This bit is set automatically by the UCS2114 when the Error state is entered. If any other bit is set in the Interrupt Status 1 register (04h), the device will not leave the Error state. This bit is cleared automatically by the UCS2114 if the auto-recovery fault handling functionality is active and no error conditions are detected. Likewise, this bit is cleared when the PWR_EN1 control is disabled ([Note 1](#)).
- 1 = Port 1 in Error state
0 = Port 1 in Active state (no errors detected)
- bit 6 **DISCH_ERR1:** Discharge Error Port 1 - Indicates the device was unable to discharge Port1. This bit will be cleared when read if the error condition has been removed or if the ERR1 bit is cleared. This bit will cause the ALERT#1 pin to be asserted and the device to enter the Error state.
- 1 = Device was unable to Discharge V_{BUS1}
0 = No V_{BUS1} discharge error
- bit 5 **VS_LOW:** Indicates that the V_S voltage has fallen below the V_{S_UVLO} threshold and both V_{BUS1} and V_{BUS2} port power switches are held off. This bit is cleared automatically when the V_S voltage is above the V_{S_UVLO} threshold.
- 1 = V_S voltage has fallen below the V_{S_UVLO}
0 = V_S voltage is above V_{S_UVLO}
- bit 4 **KEEP_OUT1:** Port 1 Minimum Keep-out region - Indicates that the V-I output on the V_{BUS1} pin has dropped below V_{BUS_MIN} . This bit will be cleared when read if the error condition has been removed or if the ERR1 bit is cleared. This bit will cause the ALERT#1 pin to be asserted and the device to enter the Error state.
- 1 = $V_{BUS1} < V_{BUS_MIN}$
0 = $V_{BUS1} > V_{BUS_MIN}$
- bit 3 **TSD_LOW:** Indicates that the die temperature has exceeded the T_{TSD_LOW} threshold and it is still above the $T_{TSD_LOW} - T_{TSD_LOW_HYST}$. This bit is cleared automatically when the die temperature is below the $T_{TSD_LOW} - T_{TSD_LOW_HYST}$. This bit will not cause the corresponding ALERT#1 and/or ALERT#2 pins to be asserted and ERR1 and/or ERR2 bits to be set unless:
- a power switch operates in Constant Current mode
 - PWR_EN1 and/or PWR_EN2 controls transition from inactive to active
 - it is a power-up situation and PWR_EN1 and/or PWR_EN2 pins are active.
- 1 = Internal die temperature has exceeded T_{TSD_LOW}
0 = Internal die temperature has not exceeded T_{TSD_LOW}
- bit 2 **Unimplemented:** Read as '0'
- bit 1 **BACK_V1:** Back-Bias Voltage Port 1 - Indicates that the V_{BUS1} voltage has exceeded the V_S or V_{DD} voltages by more than 150 mV. This bit will be cleared when read if the error condition has been removed or if the ERR1 bit is cleared. This bit will cause the ALERT#1 pin to be asserted and the device to enter the Error state.
- 1 = $V_{BUS1} > V_S$, or $V_{BUS1} > V_{DD}$ by more than 150 mV
0 = V_{BUS1} voltage has not exceeded the V_S and V_{DD} voltages by more than 150 mV

REGISTER 8-4: INTERRUPT STATUS 1 REGISTER (ADDRESS 04H) (CONTINUED)

bit 0 **OV_LIM1:** Overcurrent Limit Port 1 - Indicates that the I_{BUS} current has exceeded both the I_{LIM} threshold and the I_{BUS_R2MIN} threshold settings for V_{BUS1} . This bit will be cleared when read if the error condition has been removed or if the ERR1 bit is cleared. This bit will cause the ALERT#1 pin to be asserted and the device to enter the Error state.

1 = Current Limit for Port 1 exceeded

0 = Current Limit for Port 1 not exceeded

Note 1: Note that the ERR1 bit does not necessarily reflect the ALERT#1 pin status. The ALERT#1 pin may be cleared or asserted without the ERR1 bit changing states.

UCS2114

REGISTER 8-5: GENERAL STATUS 2 REGISTER (ADDRESS 0FH)

| | | | | | | | |
|---------|-----|-----|----------|-------------|-----|-----|-------|
| R/C-0 | U-x | U-x | R-0 | R-0 | U-x | U-x | U-x |
| RATION2 | — | — | CC_MODE2 | PWR_EN2_CON | — | — | — |
| bit 7 | | | | | | | bit 0 |

Legend:

R = Readable bit W = Writable bit U = Unimplemented bit C = Clear on Read
-n = Value at POR '1' = Bit is set '0' = Bit is cleared x = Bit is unknown

- bit 7 **RATION2:** Indicates the state of Port 2 Rationing. This bit is cleared when read, or cleared automatically when the RATION_RST2 bit is set or the RATION_EN2 bit is cleared.
1 = Port 2 has delivered the programmed mAh of current
0 = Port 2 has not delivered the programmed mAh of current
- bit 6-5 **Unimplemented**
- bit 4 **CC_MODE2:** Indicates whether Port 2 has entered CC mode.
1 = Port 2 is in CC mode
0 = Port 2 not in CC mode
- bit 3 **PWR_EN2_CON:** Reflects the PWR_EN2 control state. This bit is set and cleared automatically with the logic expression (PWR_EN2 pin OR PWR_EN2S).
1 = Port 2 Power Enable is set
0 = Port 2 Power Enable is clear
- bit 2-0 **Unimplemented**

REGISTER 8-6: GENERAL STATUS 1 REGISTER (ADDRESS 10H)

| | | | | | | | |
|---------|-----|-----|----------|-------------|-----|-----|-------|
| R/C-0 | U-x | U-x | R-0 | R-0 | U-x | U-x | U-x |
| RATION1 | — | — | CC_MODE1 | PWR_EN1_CON | — | — | — |
| bit 7 | | | | | | | bit 0 |

Legend:

| | | | |
|-------------------|------------------|-----------------------|--------------------|
| R = Readable bit | W = Writable bit | U = Unimplemented bit | C = Clear on Read |
| -n = Value at POR | '1' = Bit is set | '0' = Bit is cleared | x = Bit is unknown |

- bit 7 **RATION1:** Indicates the state of Port 1 Rationing. This bit is cleared when read, or cleared automatically when the RATION_RST1 bit is set or the RATION_EN1 bit is cleared.
 1 = Port 1 has delivered the programmed mAh of current
 0 = Port 1 has not delivered the programmed mAh of current
- bit 6-5 **Unimplemented**
- bit 4 **CC_MODE1:** Indicates whether Port 1 has entered CC mode.
 1 = Port 1 is in CC mode
 0 = Port 1 not in CC mode
- bit 3 **PWR_EN1_CON:** Reflects the PWR_EN1 control state. This bit is set and cleared automatically with the logic expression (PWR_EN1 pin OR PWR_EN1S).
 1 = Port 1 Power Enable is set
 0 = Port 1 Power Enable is clear
- bit 2-0 **Unimplemented**

UCS2114

8.3 Configuration Registers

The Configuration registers control basic device functionality. The contents of these registers are retained in Sleep.

REGISTER 8-7: GENERAL CONFIGURATION 2 REGISTER (ADDRESS 11H)

| R/W-0 | U-0 | R/W-0 | R/W-0 | R/W-0 | R/W-1 | U-1 | U-0 |
|-------------|-----|--------|----------|------------------|-------|-----|-------|
| ALERT2_MASK | — | DSCHG2 | PWR_EN2S | DISCHG_TIME<1:0> | — | — | — |
| bit 7 | | | | | | | bit 0 |

Legend:

R = Readable bit

W = Writable bit

U = Unimplemented bit

C = Clear on Read

-n = Value at POR

'1' = Bit is set

'0' = Bit is cleared

x = Bit is unknown

- bit 7 **ALERT2_MASK:** Mask errors for all interrupts in [Register 8-3](#) except OV_LIM2 and TSD.
1 = The ALERT#2 pin will only assert if a OV_LIM2 or TSD is detected
0 = The ALERT#2 pin will be asserted if an error condition or indicator event is detected
- bit 6 **Unimplemented**
- bit 5 **DSCHG2:** Forces the V_{BUS2} to be reset and discharged when the UCS2114 is in the Active state and the EN_VBUS_DISCHG bit is logic '1'. Writing this bit to a logic '1' will cause the port power switch to be opened and the discharge circuitry to activate and discharge V_{BUS} . Actual discharge time is controlled by DISCHG_TIME<1:0>. This bit must be cleared by the SMBus master after the forced V_{BUS} discharge.
1 = V_{BUS2} discharge initiated
0 = Port 2 not in discharge
- bit 4 **PWR_EN2S:** Power Enable Port 2 override - This bit is OR'ed with the PWR_EN2 pin. Thus, if the polarity is set to active-high, either the PWR_EN2 pin or this bit must be '1' to enable the port power switch.
- bit 3-2 **DISCHG_TIME<1:0>:** Discharge time - sets $t_{DISCHARGE}$. The discharge time value is the same for both ports.
00 = 100 ms
01 = 200 ms
10 = 300 ms
11 = 400 ms
- bit 1-0 **Unimplemented**

REGISTER 8-8: GENERAL CONFIGURATION 1 REGISTER (ADDRESS 12H)

| R/W-0 | U-0 | R/W-0 | R/W-0 | U | R/W-0 | U-1 | U-0 |
|-------------|-----|--------|----------|---|----------------|-------|-----|
| ALERT1_MASK | — | DSCHG1 | PWR_EN1S | — | EN_VBUS_DISCHG | — | — |
| bit 7 | | | | | | bit 0 | |

Legend:

| | | | |
|-------------------|------------------|-----------------------|--------------------|
| R = Readable bit | W = Writable bit | U = Unimplemented bit | C = Clear on Read |
| -n = Value at POR | '1' = Bit is set | '0' = Bit is cleared | x = Bit is unknown |

- bit 7 **ALERT1_MASK:** Mask errors for all interrupts in [Register 8-4](#) except OV_LIM1 and TSD.
 1 = The ALERT#1 pin will only assert if a OV_LIM1 or TSD is detected
 0 = The ALERT#1 pin will be asserted if an error condition or indicator event is detected
- bit 6 **Unimplemented**
- bit 5 **DSCHG1:** Forces the V_{BUS1} to be reset and discharged when the UCS2114 is in the Active state and the EN_VBUS_DISCHG bit is logic '1'. Writing this bit to a logic '1' will cause the port power switch to be opened and the discharge circuitry to activate to discharge V_{BUS} . Actual discharge time is controlled by DISCHG_TIME<1:0>. This bit must be cleared by the SMBus master after the forced V_{BUS} discharge.
 1 = V_{BUS1} discharge initiated
 0 = Port 1 not in discharge
- bit 4 **PWR_EN1S:** Power Enable Port 1 override - This bit is OR'ed with the PWR_EN1 pin. Thus, if the polarity is set to active-high, either the PWR_EN1 pin or this bit must be '1' to enable the port power switch.
- bit 3 **Unimplemented**
- bit 2 **EN_VBUS_DISCHG:** Enables V_{BUS} discharge circuitry.
 If it is '0', it completely disables all the automatic V_{BUS} discharges from happening and allows only manual V_{BUS} discharges (the SMBus master must set and clear DISCHG_LOAD2 and DISCHG_LOAD1 bits from the Current Limit Behavior Registers 23h and 24h). Setting DSCHG2 and DSCHG1 bits from the General Configuration 2 and 1 registers 11h and 12h does not have any effect in this case ([Note 1](#)).
 If it is '1', the V_{BUS} is discharged automatically as described in [Section 6.4 "V_{BUS} Discharge"](#). The V_{BUS} can be discharged manually by the SMBus master only by setting DSCHG2 and DSCHG1 bits from the General Configuration 2 and 1 registers 11h and 12h. Setting DISCHG_LOAD2 and DISCHG_LOAD1 bits from the Current Limit Behavior registers 23h and 24h doesn't have any effect in this case.
- bit 1-0 **Unimplemented**
- Note 1:** When the automatic V_{BUS} discharges are disabled (EN_VBUS_DISCHG is '0'), the UCS2114 will not check that the V_{BUS} voltage is below the V_{TEST} level after the manual V_{BUS} discharges.

UCS2114

REGISTER 8-9: GENERAL CONFIGURATION 3 REGISTER (ADDRESS 13H)

| | | | | | | | |
|---------|----------|--------|-----|-----|-------|-----|-------|
| R/W-0 | U-1 | R/W-1 | U-x | U-x | R/W-0 | U-0 | U-0 |
| PIN_IGN | RESERVED | DIS_TO | — | — | BOOST | — | — |
| bit 7 | | | | | | | bit 0 |

Legend:

| | | | |
|-------------------|------------------|-----------------------|--------------------|
| R = Readable bit | W = Writable bit | U = Unimplemented bit | C = Clear on Read |
| -n = Value at POR | '1' = Bit is set | '0' = Bit is cleared | x = Bit is unknown |

- bit 7 **PIN_IGN:** Ignores the PWR_EN1 and PWR_EN2 pin states when determining the power state. This bit is retained in Sleep.
1 = PWR_EN1 and PWR_EN2 pin states are ignored.
0 = Power state is determined by the OR'd combination of the PWR_EN1 and PWR_EN2 pins states and the corresponding PWR_EN1S and PWR_EN2S bit states.
- bit 6 **Reserved:** Do not change
- bit 5 **DIS_TO:** Disable Time Out - Disables the SMBus time out feature.
1 = Time out disabled
0 = Time out enabled
- bit 4-3 **Unimplemented**
- bit 2 **BOOST:** Indicates that the I_{BUS} current is higher than I_{BOOST} on V_{BUS1} or V_{BUS2} (bit is OR'ed).
1 = I_{BUS} has exceeded I_{BOOST} on either or both ports
0 = I_{BUS} is less than I_{BOOST} on either port individually
- bit 1-0 **Unimplemented:** Read as '0'

8.4 Current Limit Register

The Current Limit register controls the I_{LIM} used by the port power switch. The default setting is based on the resistor on the COMM_ILIM pin and this value cannot be changed to be higher than hardware set value. The contents of this register are retained in Sleep.

REGISTER 8-10: CURRENT LIMIT REGISTER (ADDRESS 14H)

| | | | | | | | | |
|-------|-----|-----------------|-------|-------|-----------------|-------|-------|-------|
| U-0 | U-0 | R/W-0 | R/W-0 | R/W-0 | R/W-0 | R/W-0 | R/W-0 | |
| — | — | ILIM_PORT1<2:0> | | | ILIM_PORT2<2:0> | | | |
| bit 7 | | | | | | | | bit 0 |

Legend:

| | | | |
|-------------------|------------------|-----------------------|--------------------|
| R = Readable bit | W = Writable bit | U = Unimplemented bit | |
| -n = Value at POR | '1' = Bit is set | '0' = Bit is cleared | x = Bit is unknown |

- bit 7-6 **Unimplemented:** Read as '0'
- bit 5-3 **ILIM_PORT1<2:0>:** Sets the I_{LIM} value for Port 1
- 000 = 0.53A
 - 001 = 0.96A
 - 010 = 1.07A
 - 011 = 1.28A
 - 100 = 1.6A
 - 101 = 2.13A
 - 110 = 2.67A
 - 111 = 3.2A
- bit 2-0 **ILIM_PORT2<2:0>:** Sets the I_{LIM} value for Port 2
- 000 = 0.53A
 - 001 = 0.96A
 - 010 = 1.07A
 - 011 = 1.28A
 - 100 = 1.6A
 - 101 = 2.13A
 - 110 = 2.67A
 - 111 = 3.2A

UCS2114

8.5 Auto-Recovery Register

The contents of this register are retained in Sleep.

The Auto-Recovery Configuration register sets the parameters used when the Auto-Recovery fault handling algorithm is invoked. Once the Auto-Recovery fault handling algorithm has checked the overtemperature and back-drive conditions, it will set the I_{LIM} value to I_{TEST} and then turn on the port power switch and start the t_{TST} timer. If, after the timer has expired, the V_{BUS} voltage is less than V_{TEST} , then it is assumed that a short-circuit condition is present and the Error state is restarted for Auto Recovery.

REGISTER 8-11: AUTO RECOVERY CONFIGURATION REGISTER (ADDRESS 15H)

| | | | | | | | |
|--------|-------------|-------|-------|-----------|-------|--------------|-------|
| R/W-0 | R/W-0 | R/W-1 | R/W-0 | R/W-1 | R/W-0 | R/W-1 | R/W-0 |
| LATCHS | TCYCLE<2:0> | | | TTST<1:0> | | VTST_SW<1:0> | |
| bit 7 | | | | | | | bit 0 |

| | | | |
|-------------------|------------------|-----------------------|--------------------|
| Legend: | | | |
| R = Readable bit | W = Writable bit | U = Unimplemented bit | |
| -n = Value at POR | '1' = Bit is set | '0' = Bit is cleared | x = Bit is unknown |

- bit 7 **LATCHS:** Latch Set - Controls the fault-handling routine that is used in the case that an error is detected.
 - 1 = Error state will be latched. In order for the UCS2114 to return to normal Active state, the ERR bit must be cleared by the user.
 - 0 = The UCS2114 will automatically retry when an error condition is detected.

- bit 6-4 **TCYCLE<2:0>:** Defines the delay (t_{CYCLE}) after the Error state is entered before the Auto-Recovery fault handling algorithm is started as shown below.
 - 000 = 15 ms
 - 001 = 20 ms
 - 010 = 25 ms
 - 011 = 30 ms
 - 100 = 35 ms
 - 101 = 40 ms
 - 110 = 45 ms
 - 111 = 50 ms

- bit 3-2 **TTST<1:0>:** Retry Duration timer - Sets the t_{TST} as shown below
 - 00 = 10 ms
 - 01 = 15 ms
 - 10 = 20 ms
 - 11 = 25 ms

- bit 1-0 **VTST_SW<1:0>:** Short-circuit voltage threshold V_{TEST} that must be crossed during retries to declare the short removed
 - 00 = 250 mV
 - 01 = 500 mV
 - 10 = 750 mV
 - 11 = 1000 mV

8.6 Total Accumulated Charge Registers

The Total Accumulated Charge registers store the total accumulated charge delivered from the V_S source to a portable device. The bit weighting of the registers is given in mAh. The register value is reset to 00_00h only when the RATION_RST bit is set or if the RATION_EN bit is cleared. This value will be retained when the device transitions out of the Active state and resumes accumulation, if the device returns to the Active state and charge rationing is still enabled.

These registers are updated every one (1) second while the UCS2114 is in the Active power state. Every time the value is updated, it is compared against the target value in the Charge Rationing Threshold registers. This data is retained in the Sleep state.

REGISTER 8-12: PORT2 TOTAL ACCUMULATED CHARGE REGISTERS (ADDRESSES 16H, 17H, 18H AND 19H)

| | | | | | | | |
|-------------|-----|-----|-----|--------|-----|-----|-----|
| R-0 | R-0 | R-0 | R-0 | R-0 | R-0 | R-0 | R-0 |
| TAC2<25:18> | | | | | | | |
| bit 31 | | | | bit 24 | | | |

| | | | | | | | |
|-------------|-----|-----|-----|--------|-----|-----|-----|
| R-0 | R-0 | R-0 | R-0 | R-0 | R-0 | R-0 | R-0 |
| TAC2<17:10> | | | | | | | |
| bit 23 | | | | bit 16 | | | |

| | | | | | | | |
|-----------|-----|-----|-----|-------|-----|-----|-----|
| R-0 | R-0 | R-0 | R-0 | R-0 | R-0 | R-0 | R-0 |
| TAC2<9:2> | | | | | | | |
| bit 15 | | | | bit 8 | | | |

| | | | | | | | |
|-----------|-----|-----|-----|-------|-----|-----|-----|
| R-0 | R-0 | U-0 | U-0 | U-0 | U-0 | U-0 | U-0 |
| TAC2<1:0> | | — | — | — | — | — | — |
| bit 7 | | | | bit 0 | | | |

Legend:

R = Readable bit W = Writable bit U = Unimplemented bit
 -n = Value at POR '1' = Bit is set '0' = Bit is cleared x = Bit is unknown

bit 31-6 **TAC2<25:0>**: Total Accumulated Charge Port 2 - Each LSB of this 26-bit value equals 0.00367 mAh

bit 5-0 **Unimplemented**: Read as '0'

UCS2114

REGISTER 8-13: PORT1 TOTAL ACCUMULATED CHARGE REGISTERS (ADDRESSES 1AH, 1BH, 1CH AND 1DH)

| | | | | | | | |
|-------------|-----|-----|-----|--------|-----|-----|-----|
| R-0 | R-0 | R-0 | R-0 | R-0 | R-0 | R-0 | R-0 |
| TAC1<25:18> | | | | | | | |
| bit 31 | | | | bit 24 | | | |

| | | | | | | | |
|-------------|-----|-----|-----|--------|-----|-----|-----|
| R-0 | R-0 | R-0 | R-0 | R-0 | R-0 | R-0 | R-0 |
| TAC1<17:10> | | | | | | | |
| bit 23 | | | | bit 16 | | | |

| | | | | | | | |
|-----------|-----|-----|-----|-------|-----|-----|-----|
| R-0 | R-0 | R-0 | R-0 | R-0 | R-0 | R-0 | R-0 |
| TAC1<9:2> | | | | | | | |
| bit 15 | | | | bit 8 | | | |

| | | | | | | | |
|-----------|-----|-------|-----|-----|-----|-----|-----|
| R-0 | R-0 | U-0 | U-0 | U-0 | U-0 | U-0 | U-0 |
| TAC1<1:0> | | — | — | — | — | — | — |
| bit 7 | | bit 0 | | | | | |

Legend:

R = Readable bit

W = Writable bit

U = Unimplemented bit

-n = Value at POR

'1' = Bit is set

'0' = Bit is cleared

x = Bit is unknown

bit 31-6 **TAC1<25:0>**: Total Accumulated Charge Port 1 - Each LSB of this 26-bit value equals 0.00367 mAh

bit 5-0 **Unimplemented**: Read as '0'

8.7 Charge Rationing Threshold Registers

The Charge Rationing Threshold registers set the maximum allowed charge that will be delivered to a portable device. Every time the Total Accumulated Charge registers are updated, the value is checked against this limit. If the value meets or exceeds this limit, the RATION(1/2) bit is set and action taken according to the RATION_BEH1<1:0> and RATION_BEH2<1:0> bits.

REGISTER 8-14: PORT 2 CHARGE RATIONING THRESHOLD REGISTERS (ADDRESSES 1EH AND 1FH)

| | | | | | | | |
|-----------|-------|-------|-------|-------|-------|-------|-------|
| R/W-1 | R/W-1 | R/W-1 | R/W-1 | R/W-1 | R/W-1 | R/W-1 | R/W-1 |
| CT2<15:8> | | | | | | | |
| bit 15 | | | | bit 8 | | | |

| | | | | | | | |
|----------|-------|-------|-------|-------|-------|-------|-------|
| R/W-1 | R/W-1 | R/W-1 | R/W-1 | R/W-1 | R/W-1 | R/W-1 | R/W-1 |
| CT2<7:0> | | | | | | | |
| bit 7 | | | | bit 0 | | | |

Legend:

| | | |
|-------------------|------------------|-----------------------|
| R = Readable bit | W = Writable bit | U = Unimplemented bit |
| -n = Value at POR | '1' = Bit is set | '0' = Bit is cleared |
| | | x = Bit is unknown |

bit 15-0 **CT2<15:0>**: Charge Rationing Threshold Port 2 - Each LSB of this 16-bit value equals 3.76 mAh

REGISTER 8-15: PORT 1 CHARGE RATIONING THRESHOLD REGISTERS (ADDRESSES 20H AND 21H)

| | | | | | | | |
|-----------|-------|-------|-------|-------|-------|-------|-------|
| R/W-1 | R/W-1 | R/W-1 | R/W-1 | R/W-1 | R/W-1 | R/W-1 | R/W-1 |
| CT1<15:8> | | | | | | | |
| bit 15 | | | | bit 8 | | | |

| | | | | | | | |
|----------|-------|-------|-------|-------|-------|-------|-------|
| R/W-1 | R/W-1 | R/W-1 | R/W-1 | R/W-1 | R/W-1 | R/W-1 | R/W-1 |
| CT1<7:0> | | | | | | | |
| bit 7 | | | | bit 0 | | | |

Legend:

| | | |
|-------------------|------------------|-----------------------|
| R = Readable bit | W = Writable bit | U = Unimplemented bit |
| -n = Value at POR | '1' = Bit is set | '0' = Bit is cleared |
| | | x = Bit is unknown |

bit 15-0 **CT1<15:0>**: Charge Rationing Threshold Port 1 - Each LSB of this 16-bit value equals 3.76 mAh

UCS2114

REGISTER 8-16: RATION CONFIGURATION REGISTER (ADDRESS 22H)

| | | | | | | | |
|---------|----------|---------------|-------|---------|----------|---------------|-------|
| R/W-0 | R/W-0 | R/W-0 | R/W-1 | R/W-0 | R/W-0 | R/W-0 | R/W-1 |
| RTN_EN1 | RTN_RST1 | RTN_BEH1<1:0> | | RTN_EN2 | RTN_RST2 | RTN_BEH2<1:0> | |
| bit 7 | | | | | | | bit 0 |

Legend:

| | | | |
|-------------------|------------------|-----------------------|--------------------|
| R = Readable bit | W = Writable bit | U = Unimplemented bit | |
| -n = Value at POR | '1' = Bit is set | '0' = Bit is cleared | x = Bit is unknown |

- bit 7 **RTN_EN1:** Charge Ration Enable Port 1 - Enables Charge Rationing for Port 1.
 1 = Charge Rationing enabled
 0 = Charge Rationing disabled. The Total Accumulated Charge registers for Port 1 will be cleared to 00_00h and current data will no longer be accumulated. If the Total Accumulated Charge registers have already reached the Charge Rationing threshold, the applied response will be removed as if the charge rationing had been reset. This will also clear the RATION1 status bit (if set).
- bit 6 **RTN_RST1:** Port 1 Ration Reset - Resets the charge rationing functionality for Port 1.
 1 = Total Accumulated Charge registers are reset to 00_00h. In addition, when this bit is set, the RATION1 status bit will be cleared and, if there are no other errors or active indicators, the ALERT#1 pin will be released.
 0 = Normal operation. This bit must be cleared to enable charge rationing
- bit 5-4 **RTN_BEH1<1:0>:** Ration Behavior Control bits - Controls how the UCS2114 responds when the Ration Threshold has been exceeded (as shown in [Table 6-2](#)).
 00 = Report
 01 = Report and Disconnect
 10 = Disconnect and SLEEP
 11 = Ignore
- bit 3 **RTN_EN2:** Charge Ration Enable Port 2 - Enables Charge Rationing for Port 2.
 1 = Charge Rationing enabled
 0 = Charge Rationing disabled. The Total Accumulated Charge registers for Port 2 will be cleared to 00_00h and current data will no longer be accumulated. If the Total Accumulated Charge registers have already reached the Charge Rationing threshold, the applied response will be removed as if the charge rationing had been reset. This will also clear the RATION2 status bit (if set).
- bit 2 **RTN_RST2:** Port 2 Ration Reset - Resets the charge rationing functionality for Port 2.
 1 = Total Accumulated Charge registers are reset to 00_00h. In addition, when this bit is set, the RATION2 status bit will be cleared and, if there are no other errors or active indicators, the ALERT#2 pin will be released.
 0 = Normal operation. This bit must be cleared to enable charge rationing.
- bit 1-0 **RTN_BEH2<1:0>:** Ration Behavior Control bits - Controls how the UCS2114 responds when the Ration threshold has been exceeded (as shown in [Table 6-2](#)).
 00 = Report
 01 = Report and Disconnect
 10 = Disconnect and SLEEP
 11 = Ignore

8.8 Current Limit Behavior Registers

The Current Limit Behavior register stores the values used by the applied current limiting mode (Trip or CC). The contents of this register are not retained in Sleep.

REGISTER 8-17: PORT 2 CURRENT LIMIT BEHAVIOR REGISTER (ADDRESS 23H)

| | | | | | | | |
|--------------------|-------|--------------|-------------------|-------|----------|----------|-------|
| R/W-1 | R/W-0 | R/W-0 | R/W-1 | R/W-0 | R/W-1 | R/W-1 | R/W-0 |
| SEL_VBUS2_MIN<1:0> | | DISCHG_LOAD2 | SEL_R2_IMIN2<2:0> | | Reserved | Reserved | |
| bit 7 | | | | | | bit 0 | |

Legend:

R = Readable bit

W = Writable bit

U = Unimplemented bit

-n = Value at POR

'1' = Bit is set

'0' = Bit is cleared

x = Bit is unknown

bit 7-6 **SEL_VBUS2_MIN<1:0>**: Define the V_{BUS_MIN} voltage for Port 2 as follows:

00 = 1.50V

01 = 1.75V

10 = 2.0V

11 = 2.25V

bit 5 **DISCHG_LOAD2**: Connects the internal 100Ω load to discharge V_{BUS2} (**Note 1**). The SMBus master must set this bit to discharge V_{BUS2} if the EN_VBUS_DISCHG bit from the General Configuration 1 register (address 12h) is '0'. This functionality doesn't use any timer. The discharge time is controlled by the SMBus master, which must clear this bit when its internal timer expires. The difference from DSCHG2 bit from the General Configuration 2 register (address 11h) is that, when that bit is set, the discharge time is controlled by the UCS2114 internal timer.

The state of this bit is ignored when the EN_VBUS_DISCHG bit from the General Configuration 1 register (address 12h) is '1'.

bit 4-2 **SEL_R2_IMIN2<2:0>**: Defines the I_{BUS_R2MIN} current

000 = 100 mA

001 = 530 mA

010 = 960 mA

011 = 1280 mA

100 = 1600 mA

101 = 2130 mA

bit 1-0 **Reserved**: Do not change

Note 1: If the corresponding power switch is still turned on (PWR_EN2 control is active) while DISCHG_LOAD2 bit is set, the internal 100Ω load will be connected in parallel with the load on the V_{BUS2} pins.

UCS2114

REGISTER 8-18: PORT 1 CURRENT LIMIT BEHAVIOR REGISTER (ADDRESS 24H)

| | | | | | | | |
|--------------------|--------------|-------------------|-------|-------|----------|----------|-------|
| R/W-1 | R/W-0 | R/W-0 | R/W-1 | R/W-0 | R/W-1 | R/W-1 | R/W-0 |
| SEL_VBUS1_MIN<1:0> | DISCHG_LOAD1 | SEL_R2_IMIN1<2:0> | | | Reserved | Reserved | |
| bit 7 | | | | | | bit 0 | |

Legend:

R = Readable bit W = Writable bit U = Unimplemented bit
-n = Value at POR '1' = Bit is set '0' = Bit is cleared x = Bit is unknown

bit 7-6 **SEL_VBUS1_MIN<1:0>**: Define the V_{BUS_MIN} voltage for Port 1 as follows:

00 = 1.50V
01 = 1.75V
10 = 2.0V
11 = 2.25V

bit 5 **DISCHG_LOAD1**: Connects the internal 100Ω load to discharge V_{BUS1} (**Note 1**). The SMBus master must set this bit to discharge V_{BUS1} if the EN_VBUS_DISCHG bit from the General Configuration 1 register (address 12h) is '0'. This functionality doesn't use any timer. The discharge time is controlled by the SMBus master, which must clear this bit when its internal timer expires. The difference from DSCHG1 bit from the General Configuration 1 register (address 12h) is that, when that bit is set, the discharge time is controlled by the UCS2114 internal timer.

The state of this bit is ignored when the EN_VBUS_DISCHG bit from the General Configuration 1 register (address 12h) is '1'.

bit 4-2 **SEL_R2_IMIN1<2:0>**: Defines the I_{BUS_R2MIN} current

000 = 100 mA
001 = 530 mA
010 = 960 mA
011 = 1280 mA
100 = 1600 mA
101 = 2130 mA

bit 1-0 **Reserved**: Do not change

Note 1: If the corresponding power switch is still turned on (PWR_EN1 control is active) while DISCHG_LOAD1 bit is set, the internal 100Ω load will be connected in parallel with the load on the V_{BUS1} pins.

8.9 Product ID Register

The Product ID register stores a unique 8-bit value that identifies the UCS device family.

REGISTER 8-19: PRODUCT ID REGISTER (ADDRESS FDH)

| | | | | | | | |
|----------|-----|-----|-----|-----|-----|-----|-------|
| R-1 | R-1 | R-1 | R-0 | R-0 | R-0 | R-1 | R-1 |
| PID<7:0> | | | | | | | |
| bit 7 | | | | | | | bit 0 |

Legend:

| | | |
|-------------------|------------------|-----------------------|
| R = Readable bit | W = Writable bit | U = Unimplemented bit |
| -n = Value at POR | '1' = Bit is set | '0' = Bit is cleared |
| | | x = Bit is unknown |

bit 7-0 **PID<7:0>**: Product ID for the UCS2114

8.10 Manufacture ID Register

The Manufacturer ID register stores a unique 8-bit value that identifies Microchip Technology Inc.

REGISTER 8-20: MANUFACTURER ID REGISTER (ADDRESS FEH)

| | | | | | | | |
|----------|-----|-----|-----|-----|-----|-----|-------|
| R-0 | R-1 | R-0 | R-1 | R-1 | R-1 | R-0 | R-1 |
| MID<7:0> | | | | | | | |
| bit 7 | | | | | | | bit 0 |

Legend:

| | | |
|-------------------|------------------|-----------------------|
| R = Readable bit | W = Writable bit | U = Unimplemented bit |
| -n = Value at POR | '1' = Bit is set | '0' = Bit is cleared |
| | | x = Bit is unknown |

bit 7-0 **MID<7:0>**: Manufacturer ID for Microchip

8.11 Revision Register

The Revision register stores an 8-bit value that represents the part revision.

REGISTER 8-21: REVISION REGISTER (ADDRESS FFH)

| | | | | | | | |
|----------|-----|-----|-----|-----|-----|-----|-------|
| R-1 | R-0 | R-0 | R-0 | R-0 | R-0 | R-0 | R-1 |
| REV<7:0> | | | | | | | |
| bit 7 | | | | | | | bit 0 |

Legend:

| | | |
|-------------------|------------------|-----------------------|
| R = Readable bit | W = Writable bit | U = Unimplemented bit |
| -n = Value at POR | '1' = Bit is set | '0' = Bit is cleared |
| | | x = Bit is unknown |

bit 7-0 **REV<7:0>**: Part Revision

UCS2114

NOTES:

UCS2114

9.0 PACKAGING INFORMATION

9.1 Package Marking Information

3 x 3 mm VQFN, 20-lead

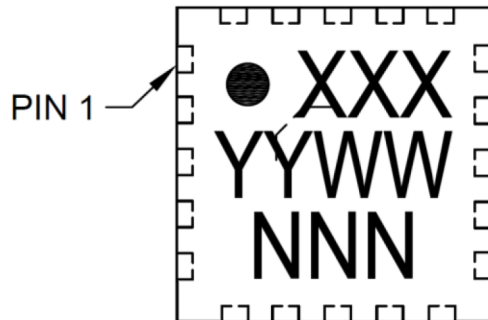

Example

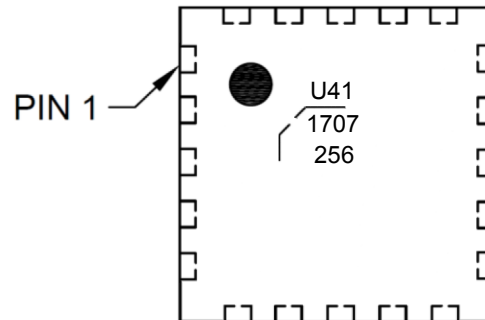

| | | |
|----------------|---|--|
| Legend: | XX...X | Customer-specific information |
| | Y | Year code (last digit of calendar year) |
| | YY | Year code (last 2 digits of calendar year) |
| | WW | Week code (week of January 1 is week '01') |
| | NNN | Alphanumeric traceability code |
| | (e3) | Pb-free JEDEC® designator for Matte Tin (Sn) |
| | * | This package is Pb-free. The Pb-free JEDEC designator (e3) can be found on the outer packaging for this package. |
| Note: | In the event the full Microchip part number cannot be marked on one line, it will be carried over to the next line, thus limiting the number of available characters for customer-specific information. | |

UCS2114

20-Lead Very Thin Plastic Quad Flat, No Lead Package (LXX) - 3x3x0.9 mm Body [VQFN] No Exposed Pad

Note: For the most current package drawings, please see the Microchip Packaging Specification located at <http://www.microchip.com/packaging>

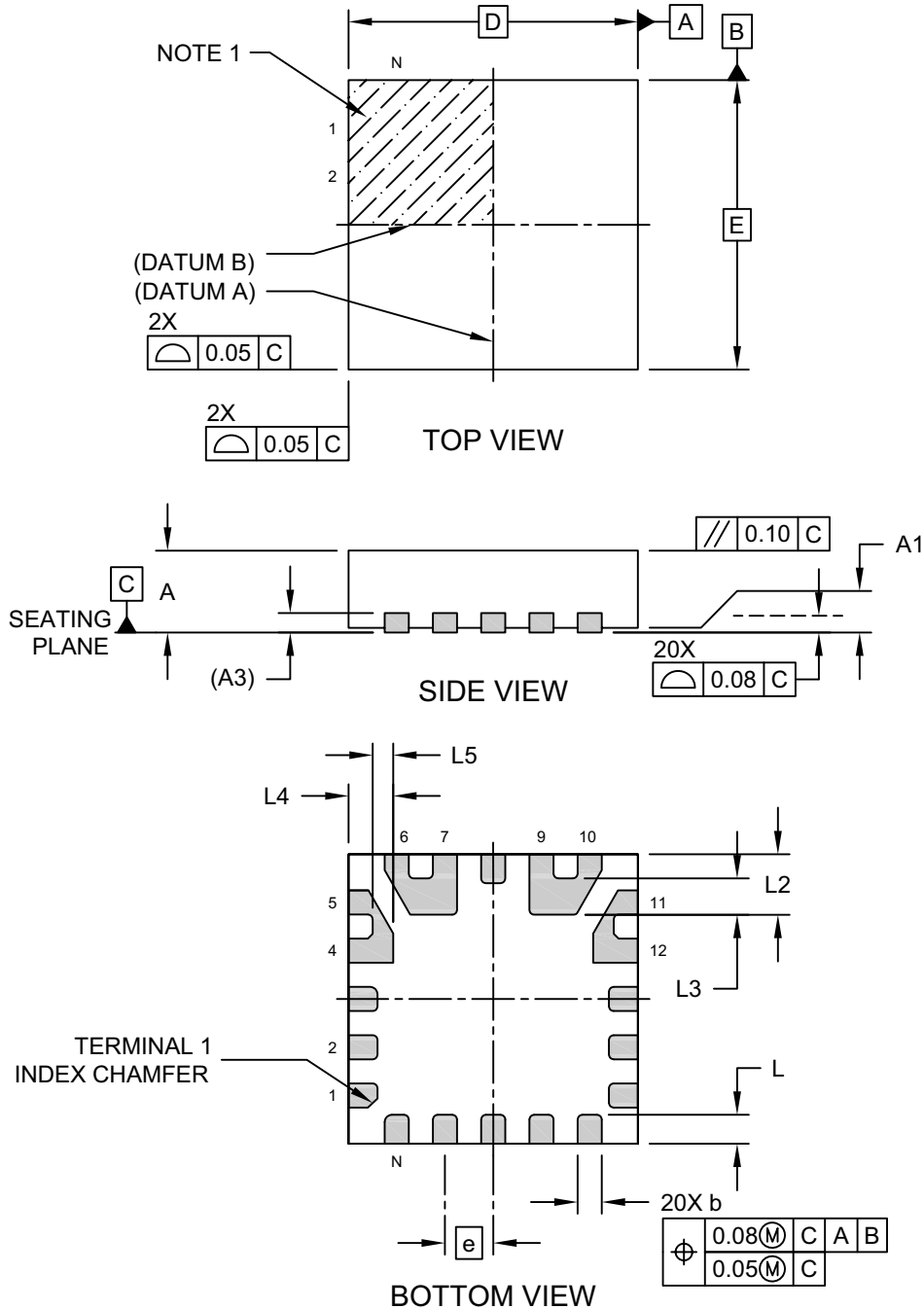

Microchip Technology Drawing C04-421 Rev C Sheet 1 of 2

20-Lead Very Thin Plastic Quad Flat, No Lead Package (LXX) - 3x3x0.9 mm Body [VQFN] No Exposed Pad

Note: For the most current package drawings, please see the Microchip Packaging Specification located at <http://www.microchip.com/packaging>

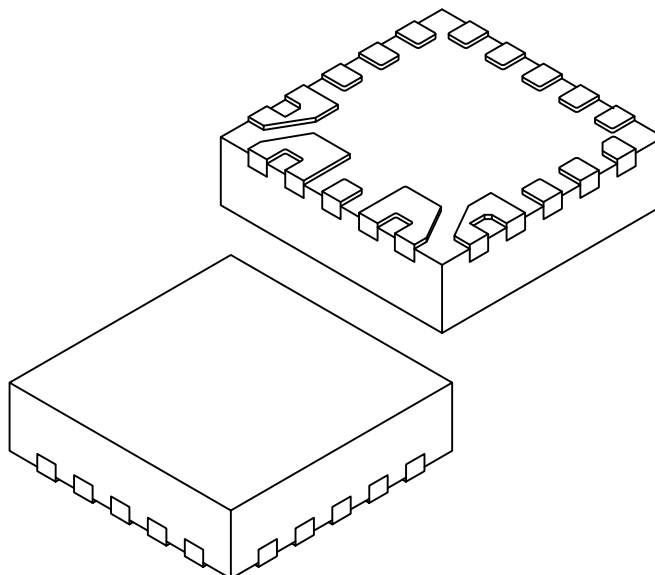

| Dimension Limits | Units | MILLIMETERS | | |
|---------------------|-------|-------------|------|------|
| | | MIN | NOM | MAX |
| Number of Terminals | N | 20 | | |
| Pitch | e | 0.50 BSC | | |
| Overall Height | A | 0.80 | 0.85 | 0.90 |
| Standoff | A1 | 0.00 | 0.02 | 0.05 |
| Terminal Thickness | A3 | 0.203 REF | | |
| Overall Length | D | 3.00 BSC | | |
| Overall Width | E | 3.00 BSC | | |
| Terminal Length | L | 0.25 | 0.30 | 0.35 |
| Terminal Length | L2 | 0.58 | 0.63 | 0.68 |
| Terminal Length | L3 | 0.33 | 0.38 | 0.43 |
| Terminal Length | L4 | 0.41 | 0.46 | 0.51 |
| Terminal Length | L5 | 0.16 | 0.21 | 0.26 |
| Terminal Width | b | 0.20 | 0.25 | 0.30 |

Notes:

1. Pin 1 visual index feature may vary, but must be located within the hatched area.
2. Package is saw singulated
3. Dimensioning and tolerancing per ASME Y14.5M

BSC: Basic Dimension. Theoretically exact value shown without tolerances.

REF: Reference Dimension, usually without tolerance, for information purposes only.

Microchip Technology Drawing C04-421 Rev C Sheet 2 of 2

UCS2114

20-Lead Very Thin Plastic Quad Flat, No Lead Package (LXX) - 3x3x0.9 mm Body [VQFN] No Exposed Pad

Note: For the most current package drawings, please see the Microchip Packaging Specification located at <http://www.microchip.com/packaging>

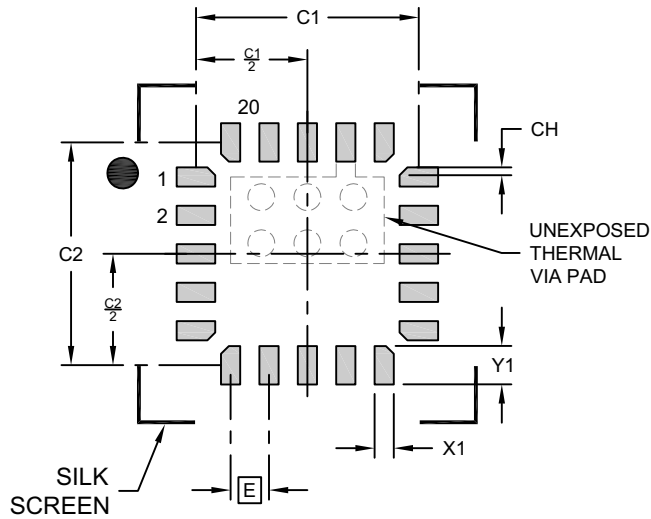

EXPOSED METAL

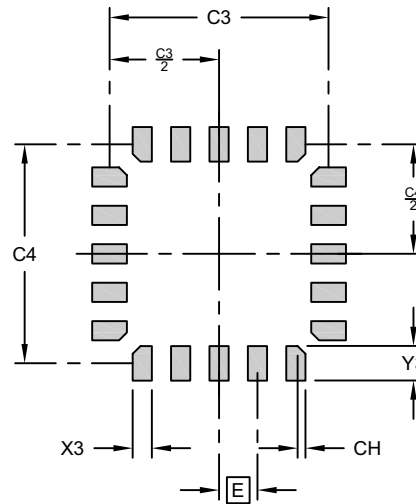

SOLDER STENCIL OPENINGS

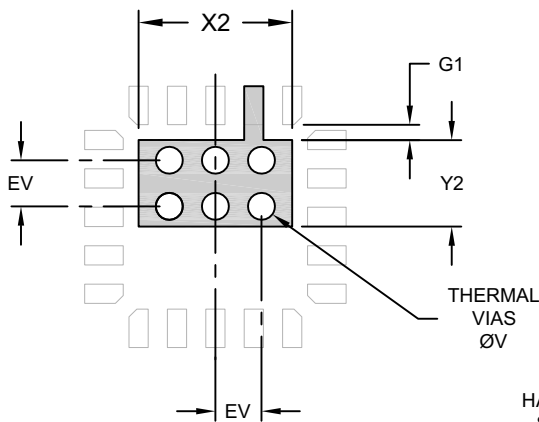

FILLED THERMAL VIAS

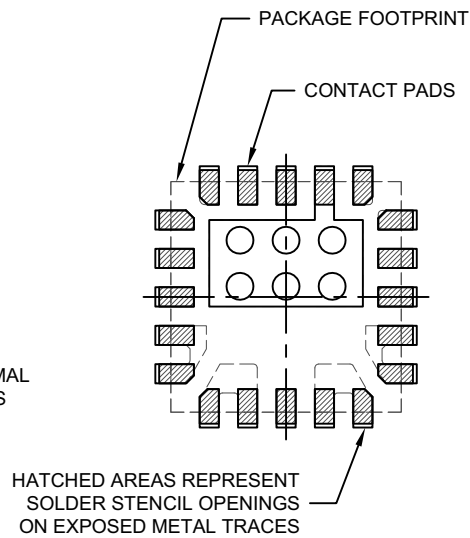

OVERLAY

20-Lead Very Thin Plastic Quad Flat, No Lead Package (LXX) - 3x3x0.9 mm Body [VQFN] No Exposed Pad

Note: For the most current package drawings, please see the Microchip Packaging Specification located at <http://www.microchip.com/packaging>

RECOMMENDED LAND PATTERN & SOLDER STENCIL OPENING

| Dimension Limits | Units | MILLIMETERS | | |
|---------------------------------|-------|-------------|------|------|
| | | MIN | NOM | MAX |
| Contact Pitch | E | 0.50 BSC | | |
| Contact Pad Spacing | C1 | | 2.90 | |
| Contact Pad Spacing | C2 | | 2.90 | |
| Contact Pad Width (X20) | X1 | | | 0.25 |
| Contact Pad Length (X19) | Y1 | | | 0.50 |
| Chamfer (X8) | CH | | 0.10 | |
| Contact Pad to Center Pad (X10) | G1 | 0.20 | | |
| Thermal Via Pad Width | X2 | | | 2.00 |
| Thermal Via Pad Length | Y2 | | | 1.13 |
| Thermal Via Diameter (X6) | V | | 0.35 | |
| Thermal Via Pitch | EV | | 0.60 | |
| Solder Stencil Opening Spacing | C3 | | 2.85 | |
| Solder Stencil Opening Spacing | C4 | | 2.85 | |
| Solder Stencil Opening | X3 | | | 0.25 |
| Solder Stencil Opening | Y3 | | | 0.45 |

Notes:

1. Dimensioning and tolerancing per ASME Y14.5M
BSC: Basic Dimension. Theoretically exact value shown without tolerances.
2. For best soldering results, thermal vias, if used, should be filled to avoid solder loss during reflow process

APPENDIX A: REVISION HISTORY

Revision A (June 2017)

- Original Release of this Document.

UCS2114

NOTES:

PRODUCT IDENTIFICATION SYSTEM

To order or obtain information, e.g., on pricing or delivery, refer to the factory or the listed sales office.

| PART NO. | [I]⁽¹⁾ | =X | =X | LX |
|------------------------------|--------------------------|--|--------------------------|----------------|
| Device | Tape and Reel | Version | Temperature Range | Package |
| Device: | UCS2114: | USB Dual-Port Power Switch and Current Monitor | | |
| Tape and Reel Option: | T | = Tape and Reel ⁽¹⁾ | | |
| Version: | 1 | = SMBus address 57h | | |
| Temperature Range: | V | = -40°C to +105°C (Various) | | |
| Package: | LX | = Very Thin Plastic Quad Flat, No Lead Package - 3x3x0.9 mm (VQFN), 20LD | | |

Examples:

a) UCS2114-1-V/LX: SMBus address 57h, Various temperature, 20LD 3x3 VQFN package

b) UCS2114T-1-V/LX: Tape and Reel, SMBus address 57h, Various temperature, 20LD 3x3 VQFN package

Note 1: Tape and Reel identifier only appears in the catalog part number description. This identifier is used for ordering purposes and is not printed on the device package. Check with your Microchip Sales Office for package availability with the Tape and Reel option.

UCS2114

NOTES:

Note the following details of the code protection feature on Microchip devices:

- Microchip products meet the specification contained in their particular Microchip Data Sheet.
- Microchip believes that its family of products is one of the most secure families of its kind on the market today, when used in the intended manner and under normal conditions.
- There are dishonest and possibly illegal methods used to breach the code protection feature. All of these methods, to our knowledge, require using the Microchip products in a manner outside the operating specifications contained in Microchip's Data Sheets. Most likely, the person doing so is engaged in theft of intellectual property.
- Microchip is willing to work with the customer who is concerned about the integrity of their code.
- Neither Microchip nor any other semiconductor manufacturer can guarantee the security of their code. Code protection does not mean that we are guaranteeing the product as “unbreakable.”

Code protection is constantly evolving. We at Microchip are committed to continuously improving the code protection features of our products. Attempts to break Microchip's code protection feature may be a violation of the Digital Millennium Copyright Act. If such acts allow unauthorized access to your software or other copyrighted work, you may have a right to sue for relief under that Act.

Information contained in this publication regarding device applications and the like is provided only for your convenience and may be superseded by updates. It is your responsibility to ensure that your application meets with your specifications. MICROCHIP MAKES NO REPRESENTATIONS OR WARRANTIES OF ANY KIND WHETHER EXPRESS OR IMPLIED, WRITTEN OR ORAL, STATUTORY OR OTHERWISE, RELATED TO THE INFORMATION, INCLUDING BUT NOT LIMITED TO ITS CONDITION, QUALITY, PERFORMANCE, MERCHANTABILITY OR FITNESS FOR PURPOSE. Microchip disclaims all liability arising from this information and its use. Use of Microchip devices in life support and/or safety applications is entirely at the buyer's risk, and the buyer agrees to defend, indemnify and hold harmless Microchip from any and all damages, claims, suits, or expenses resulting from such use. No licenses are conveyed, implicitly or otherwise, under any Microchip intellectual property rights unless otherwise stated.

Microchip received ISO/TS-16949:2009 certification for its worldwide headquarters, design and wafer fabrication facilities in Chandler and Tempe, Arizona; Gresham, Oregon and design centers in California and India. The Company's quality system processes and procedures are for its PIC® MCUs and dsPIC® DSCs, KEELOQ® code hopping devices, Serial EEPROMs, microperipherals, nonvolatile memory and analog products. In addition, Microchip's quality system for the design and manufacture of development systems is ISO 9001:2000 certified.

**QUALITY MANAGEMENT SYSTEM
CERTIFIED BY DNV
= ISO/TS 16949 =**

Trademarks

The Microchip name and logo, the Microchip logo, AnyRate, AVR, AVR logo, AVR Freaks, BeaconThings, BitCloud, CryptoMemory, CryptoRF, dsPIC, FlashFlex, flexPWR, Heldo, JukeBlox, KEELOQ, KEELOQ logo, Klear, LANCheck, LINK MD, maXStylus, maXTouch, MediaLB, megaAVR, MOST, MOST logo, MPLAB, OptoLyzer, PIC, picoPower, PICSTART, PIC32 logo, Prochip Designer, QTouch, RightTouch, SAM-BA, SpyNIC, SST, SST Logo, SuperFlash, tinyAVR, UNI/O, and XMEGA are registered trademarks of Microchip Technology Incorporated in the U.S.A. and other countries.

ClockWorks, The Embedded Control Solutions Company, EtherSynch, Hyper Speed Control, HyperLight Load, IntelliMOS, mTouch, Precision Edge, and Quiet-Wire are registered trademarks of Microchip Technology Incorporated in the U.S.A.

Adjacent Key Suppression, AKS, Analog-for-the-Digital Age, Any Capacitor, AnyIn, AnyOut, BodyCom, chipKIT, chipKIT logo, CodeGuard, CryptoAuthentication, CryptoCompanion, CryptoController, dsPICDEM, dsPICDEM.net, Dynamic Average Matching, DAM, ECAN, EtherGREEN, In-Circuit Serial Programming, ICSP, Inter-Chip Connectivity, JitterBlocker, KlearNet, KlearNet logo, Mindi, MiWi, motorBench, MPASM, MPF, MPLAB Certified logo, MPLIB, MPLINK, MultiTRAK, NetDetach, Omniscient Code Generation, PICDEM, PICDEM.net, PICKit, PICtail, PureSilicon, QMatrix, RightTouch logo, REAL ICE, Ripple Blocker, SAM-ICE, Serial Quad I/O, SMART-I.S., SQI, SuperSwitcher, SuperSwitcher II, Total Endurance, TSHARC, USBCheck, VariSense, ViewSpan, WiperLock, Wireless DNA, and ZENA are trademarks of Microchip Technology Incorporated in the U.S.A. and other countries.

SQTP is a service mark of Microchip Technology Incorporated in the U.S.A.

Silicon Storage Technology is a registered trademark of Microchip Technology Inc. in other countries.

GestIC is a registered trademark of Microchip Technology Germany II GmbH & Co. KG, a subsidiary of Microchip Technology Inc., in other countries.

All other trademarks mentioned herein are property of their respective companies.

© 2017, Microchip Technology Incorporated, All Rights Reserved.
ISBN: 978-1-5224-1793-4



MICROCHIP

Worldwide Sales and Service

AMERICAS

Corporate Office
2355 West Chandler Blvd.
Chandler, AZ 85224-6199
Tel: 480-792-7200
Fax: 480-792-7277
Technical Support:
<http://www.microchip.com/support>
Web Address:
www.microchip.com

Atlanta
Duluth, GA
Tel: 678-957-9614
Fax: 678-957-1455

Austin, TX
Tel: 512-257-3370

Boston
Westborough, MA
Tel: 774-760-0087
Fax: 774-760-0088

Chicago
Itasca, IL
Tel: 630-285-0071
Fax: 630-285-0075

Dallas
Addison, TX
Tel: 972-818-7423
Fax: 972-818-2924

Detroit
Novi, MI
Tel: 248-848-4000

Houston, TX
Tel: 281-894-5983

Indianapolis
Noblesville, IN
Tel: 317-773-8323
Fax: 317-773-5453
Tel: 317-536-2380

Los Angeles
Mission Viejo, CA
Tel: 949-462-9523
Fax: 949-462-9608
Tel: 951-273-7800

Raleigh, NC
Tel: 919-844-7510

New York, NY
Tel: 631-435-6000

San Jose, CA
Tel: 408-735-9110
Tel: 408-436-4270

Canada - Toronto
Tel: 905-695-1980
Fax: 905-695-2078

ASIA/PACIFIC

Asia Pacific Office
Suites 3707-14, 37th Floor
Tower 6, The Gateway
Harbour City, Kowloon

Hong Kong
Tel: 852-2943-5100
Fax: 852-2401-3431

Australia - Sydney
Tel: 61-2-9868-6733
Fax: 61-2-9868-6755

China - Beijing
Tel: 86-10-8569-7000
Fax: 86-10-8528-2104

China - Chengdu
Tel: 86-28-8665-5511
Fax: 86-28-8665-7889

China - Chongqing
Tel: 86-23-8980-9588
Fax: 86-23-8980-9500

China - Dongguan
Tel: 86-769-8702-9880

China - Guangzhou
Tel: 86-20-8755-8029

China - Hangzhou
Tel: 86-571-8792-8115
Fax: 86-571-8792-8116

China - Hong Kong SAR
Tel: 852-2943-5100
Fax: 852-2401-3431

China - Nanjing
Tel: 86-25-8473-2460
Fax: 86-25-8473-2470

China - Qingdao
Tel: 86-532-8502-7355
Fax: 86-532-8502-7205

China - Shanghai
Tel: 86-21-3326-8000
Fax: 86-21-3326-8021

China - Shenyang
Tel: 86-24-2334-2829
Fax: 86-24-2334-2393

China - Shenzhen
Tel: 86-755-8864-2200
Fax: 86-755-8203-1760

China - Wuhan
Tel: 86-27-5980-5300
Fax: 86-27-5980-5118

China - Xian
Tel: 86-29-8833-7252
Fax: 86-29-8833-7256

ASIA/PACIFIC

China - Xiamen
Tel: 86-592-2388138
Fax: 86-592-2388130

China - Zhuhai
Tel: 86-756-3210040
Fax: 86-756-3210049

India - Bangalore
Tel: 91-80-3090-4444
Fax: 91-80-3090-4123

India - New Delhi
Tel: 91-11-4160-8631
Fax: 91-11-4160-8632

India - Pune
Tel: 91-20-3019-1500

Japan - Osaka
Tel: 81-6-6152-7160
Fax: 81-6-6152-9310

Japan - Tokyo
Tel: 81-3-6880-3770
Fax: 81-3-6880-3771

Korea - Daegu
Tel: 82-53-744-4301
Fax: 82-53-744-4302

Korea - Seoul
Tel: 82-2-554-7200
Fax: 82-2-558-5932 or
82-2-558-5934

Malaysia - Kuala Lumpur
Tel: 60-3-6201-9857
Fax: 60-3-6201-9859

Malaysia - Penang
Tel: 60-4-227-8870
Fax: 60-4-227-4068

Philippines - Manila
Tel: 63-2-634-9065
Fax: 63-2-634-9069

Singapore
Tel: 65-6334-8870
Fax: 65-6334-8850

Taiwan - Hsin Chu
Tel: 886-3-5778-366
Fax: 886-3-5770-955

Taiwan - Kaohsiung
Tel: 886-7-213-7830

Taiwan - Taipei
Tel: 886-2-2508-8600
Fax: 886-2-2508-0102

Thailand - Bangkok
Tel: 66-2-694-1351
Fax: 66-2-694-1350

EUROPE

Austria - Wels
Tel: 43-7242-2244-39
Fax: 43-7242-2244-393

Denmark - Copenhagen
Tel: 45-4450-2828
Fax: 45-4485-2829

Finland - Espoo
Tel: 358-9-4520-820

France - Paris
Tel: 33-1-69-53-63-20
Fax: 33-1-69-30-90-79

France - Saint Cloud
Tel: 33-1-30-60-70-00

Germany - Garching
Tel: 49-8931-9700

Germany - Haan
Tel: 49-2129-3766400

Germany - Heilbronn
Tel: 49-7131-67-3636

Germany - Karlsruhe
Tel: 49-721-625370

Germany - Munich
Tel: 49-89-627-144-0
Fax: 49-89-627-144-44

Germany - Rosenheim
Tel: 49-8031-354-560

Israel - Ra'anana
Tel: 972-9-744-7705

Italy - Milan
Tel: 39-0331-742611
Fax: 39-0331-466781

Italy - Padova
Tel: 39-049-7625286

Netherlands - Drunen
Tel: 31-416-690399
Fax: 31-416-690340

Norway - Trondheim
Tel: 47-7289-7561

Poland - Warsaw
Tel: 48-22-3325737

Romania - Bucharest
Tel: 40-21-407-87-50

Spain - Madrid
Tel: 34-91-708-08-90
Fax: 34-91-708-08-91

Sweden - Gothenberg
Tel: 46-31-704-60-40

Sweden - Stockholm
Tel: 46-8-5090-4654

UK - Wokingham
Tel: 44-118-921-5800
Fax: 44-118-921-5820