

3A Fast Response LDO Regulator

Features

- High-Current Capability
- Operating Input Voltage Range: 3V to 16V
- Low Dropout Voltage
- Low Ground Current
- Accurate 1% Tolerance
- Fast Transient Response
- 1.24V to 15V Adjustable Output Voltage
- Packages: TO-263-5L and TO-252-5L

Applications

- Processor Peripheral and I/O Supplies
- High-Efficiency Green Computer Systems
- Automotive Electronics
- High-Efficiency Linear Lower Supplies
- Battery-Powered Equipment
- PC Add-In Cards
- High-Efficiency Post-Regulator for Switching Supply

General Description

The MIC29302A is a high-current, low-dropout voltage regulator that uses Microchip's proprietary Super β PNP process with a PNP pass element. The 3A LDO regulator features 560 mV (full load) dropout voltage and very low ground current. Designed for high-current loads, these devices also find applications in lower current, low-dropout critical systems, where their dropout voltages and ground current values are important attributes.

Along with a total accuracy of $\pm 2\%$ (over temperature, line, and load regulation) the regulator features very fast transient recovery from input voltage surges and output load current changes.

The MIC29302A has an adjustable output that can be set by two external resistors to a voltage between 1.24V and 15V. In addition, the device is fully protected against overcurrent faults, reversed input polarity, reversed lead insertion, and overtemperature operation. A TTL/CMOS logic enable (EN) pin is available in the MIC29302A to shutdown the regulator. When not used, the device can be set to continuous operation by connecting EN to the input (IN). The MIC29302A is available in the standard and 5-pin TO-263 and TO-252 packages with an operating junction temperature range of -40°C to $+125^{\circ}\text{C}$.

Package Types

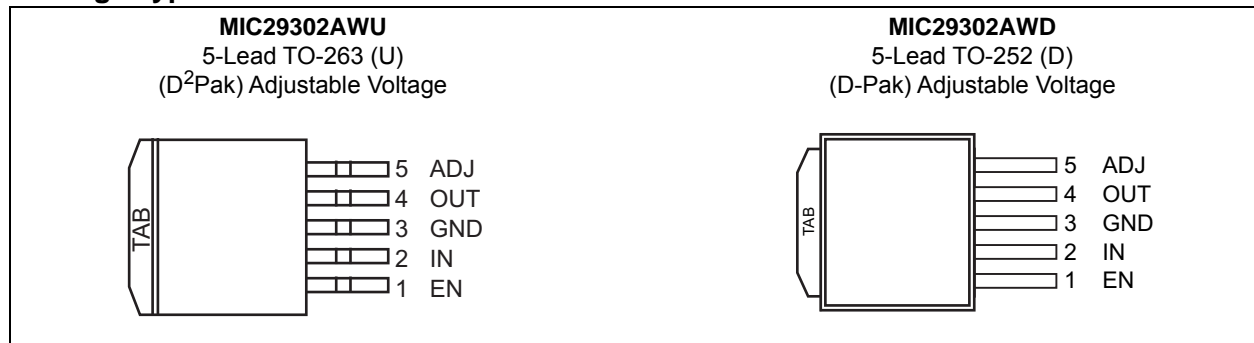

MIC29302A

Typical Application Circuit

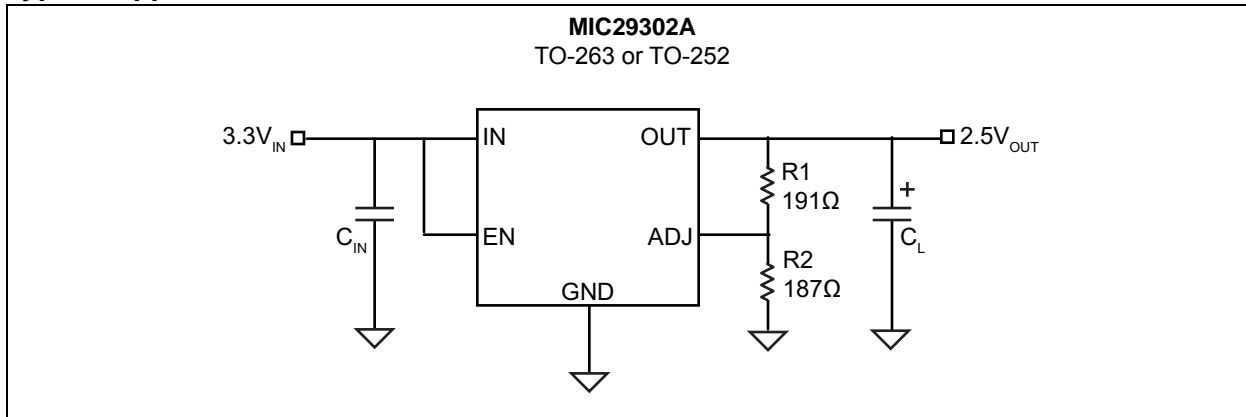

Functional Block Diagram

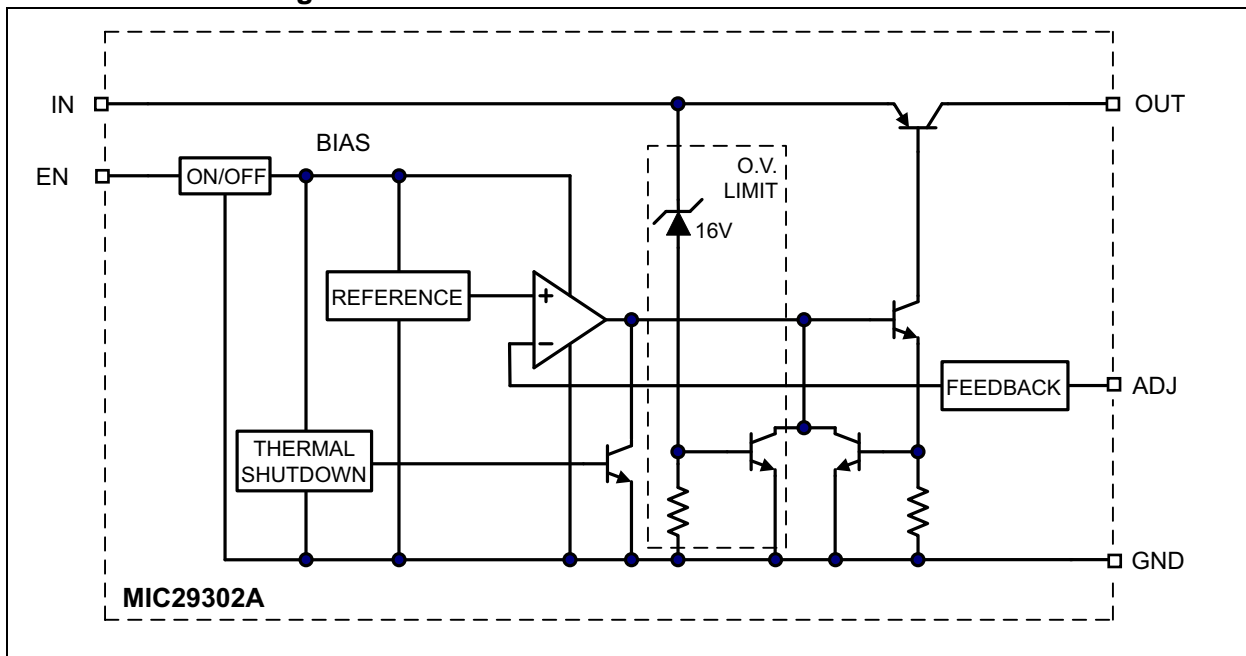

1.0 ELECTRICAL CHARACTERISTICS

Absolute Maximum Ratings †

Input Supply Voltage (V_{IN})	-20V to +20V
Enable Input Voltage (V_{EN})	-0.3V to V_{IN}
Power Dissipation	Internally Limited
ESD Rating (All Pins)	Note 1

Operating Ratings ‡

Operating Input Voltage	+3V to +16V
-------------------------	-------	-------------

† **Notice:** Stresses above those listed under “Absolute Maximum Ratings” may cause permanent damage to the device. This is a stress rating only and functional operation of the device at those or any other conditions above those indicated in the operational sections of this specification is not intended. Exposure to maximum rating conditions for extended periods may affect device reliability.

‡ **Notice:** The device is not guaranteed to function outside its operating ratings.

Note 1: Devices are ESD sensitive. Handling precautions recommended.

TABLE 1-1: ELECTRICAL CHARACTERISTICS

Electrical Characteristics: $V_{IN} = 4.184V$; $I_{OUT} = 100\text{ mA}$; $T_A = +25^\circ\text{C}$, **bold** values indicate $-40^\circ\text{C} \leq T_J \leq +125^\circ\text{C}$, unless noted. [Note 1](#)

Parameter	Symbol	Min.	Typ.	Max.	Units	Conditions
Output Voltage						
Output Voltage Accuracy	ΔV_{OUT}	-2	—	2	%	$100\text{ mA} \leq I_{OUT} \leq 3A$, $(V_{OUT} + 1V) \leq V_{IN} \leq 16V$
Line Regulation	$\frac{\Delta V_{OUT}}{\Delta V_{IN}}$	—	0.1	0.5	%	$I_{OUT} = 100\text{ mA}$, $(V_{OUT} + 1V) \leq V_{IN} \leq 16V$
Load Regulation	$\frac{\Delta V_{OUT}}{\Delta I_{OUT}}$	—	0.2	1	%	$V_{IN} = V_{OUT} + 1V$, $100\text{ mA} \leq I_{OUT} \leq 3A$
Dropout Voltage (Note 2)	V_{DO}	—	100	200	mV	$I_{OUT} = 100\text{ mA}$, $V_{IN} \geq 3.184V$
		—	300	—		$I_{OUT} = 1.5A$, $V_{IN} \geq 3.184V$
		—	500	—		$I_{OUT} = 2.75A$, $V_{IN} \geq 3.184V$
		—	560	800		$I_{OUT} = 3A$, $V_{IN} \geq 3.4V$
Ground Current						
Ground Current	I_{GND}	—	5	20	mA	$I_{OUT} = 750\text{ mA}$, $V_{IN} = V_{OUT} + 1V$
		—	15	—		$I_{OUT} = 1.5A$
		—	60	150		$I_{OUT} = 3A$
Ground Pin Current at Dropout	I_{GNDDO}	—	2	—	mA	$V_{IN} = 0.5V$ less than specified V_{OUT} ; $I_{OUT} = 10\text{ mA}$
Current Limit	I_{LIMIT}	3	4	—	A	$V_{OUT} = 0V$, Note 3
Output Noise Voltage (10 Hz to 100 kHz)	e_N	—	400	—	μV_{RMS}	$C_L = 10\text{ }\mu F$
		—	260	—		$C_L = 33\text{ }\mu F$
Ground Pin Current in Shutdown	I_{SHDN}	—	32	—	μA	Input Voltage $V_{IN} = 16V$
Reference						
Reference Voltage	V_{REF}	1.215	—	1.267	V	Note 4
Adjust Pin Bias Current	I_{ADJ}	—	40	—	nA	—
		—	—	120		

MIC29302A

TABLE 1-1: ELECTRICAL CHARACTERISTICS (CONTINUED)

Electrical Characteristics: $V_{IN} = 4.184V$; $I_{OUT} = 100\text{ mA}$; $T_A = +25^\circ\text{C}$, **bold** values indicate $-40^\circ\text{C} \leq T_J \leq +125^\circ\text{C}$, unless noted. [Note 1](#)

Parameter	Symbol	Min.	Typ.	Max.	Units	Conditions
ENABLE Input						
Input Logic Voltage	V_{ENABLE}	—	—	0.8	V	Low (OFF)
		2.4	—	—		High (ON)
Enable Pin Input Current	I_{ENABLE}	—	15	30	μA	$V_{EN} = 4.2V$
		—	—	75		
		—	—	2		$V_{EN} = 0.8V$
		—	—	4		
Regulator Output Current in Shutdown	$I_{OUT-SHDN}$	—	10	—	μA	Note 5
		—	—	20		

Note 1: Specification for packaged product only

- 2:** Dropout voltage is defined as the input-to-output differential when output voltage drops to 99% of its normal value with $V_{OUT} + 1V$ applied to V_{IN} .
- 3:** $V_{IN} = V_{OUT} (\text{nominal}) + 1V$. For example, use $V_{IN} = 4.3V$ for a 3.3V regulator or use 6V for a 5V regulator. Employ pulse testing procedure for current-limit.
- 4:** $V_{REF} \leq V_{OUT} \leq V_{IN} - 1$, $3V \leq V_{OUT} \leq 16V$, $10\text{ mA} \leq I_L \leq I_{FL}$, $T_J \leq T_{J(\text{MAX})}$.
- 5:** $V_{EN} \leq 0.8V$, $V_{IN} \leq 16V$ and $V_{OUT} = 0V$.

TEMPERATURE SPECIFICATIONS (Note 1)

Parameters	Sym.	Min.	Typ.	Max.	Units	Conditions
Temperature Ranges						
Junction Operating Temperature Range	T_J	-40	—	+125	°C	—
Storage Temperature Range	T_S	-65	—	+150	°C	—
Package Thermal Resistances						
Thermal Resistance TO-263	θ_{JC}	—	3	—	°C/W	—
Thermal Resistance TO-252	θ_{JC}	—	3	—	°C/W	—
Thermal Resistance TO-263	θ_{JA}	—	28	—	°C/W	—
Thermal Resistance TO-252	θ_{JA}	—	35	—	°C/W	—

Note 1: The maximum allowable power dissipation is a function of ambient temperature, the maximum allowable junction temperature and the thermal resistance from junction to air (i.e., T_A , T_J , θ_{JA}). Exceeding the maximum allowable power dissipation will cause the device operating junction temperature to exceed the maximum +125°C rating. Sustained junction temperatures above +125°C can impact the device reliability.

MIC29302A

2.0 TYPICAL PERFORMANCE CURVES

Note: The graphs and tables provided following this note are a statistical summary based on a limited number of samples and are provided for informational purposes only. The performance characteristics listed herein are not tested or guaranteed. In some graphs or tables, the data presented may be outside the specified operating range (e.g., outside specified power supply range) and therefore outside the warranted range.

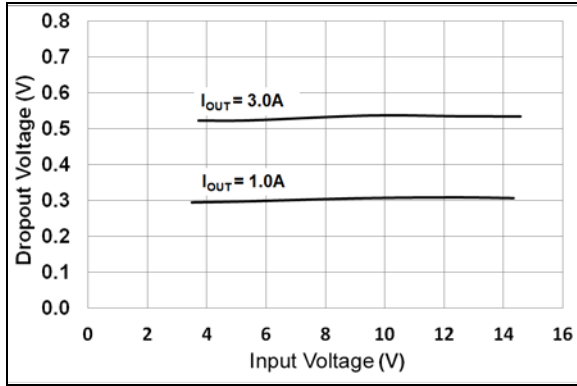

FIGURE 2-1: Dropout Voltage vs. Input Voltage.

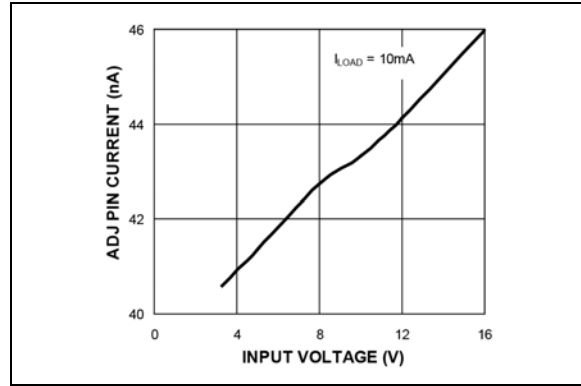

FIGURE 2-4: Adjust Pin Current vs. Input Voltage.

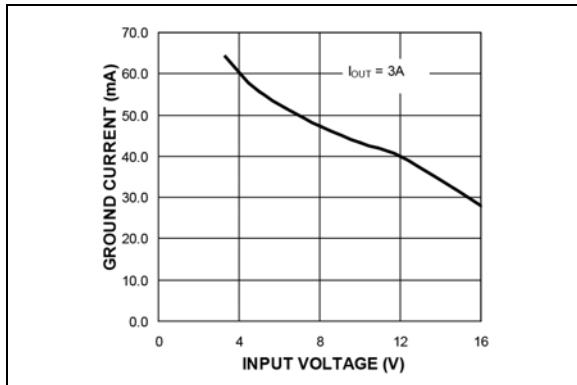

FIGURE 2-2: GND Pin Current vs. Input Voltage.

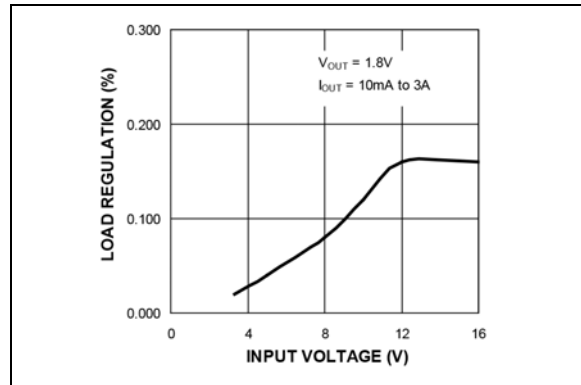

FIGURE 2-5: Load Regulation vs. Input Voltage.

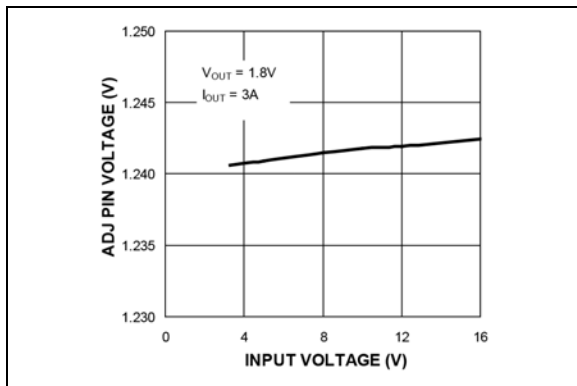

FIGURE 2-3: Adjust Pin Voltage vs. Input Voltage.

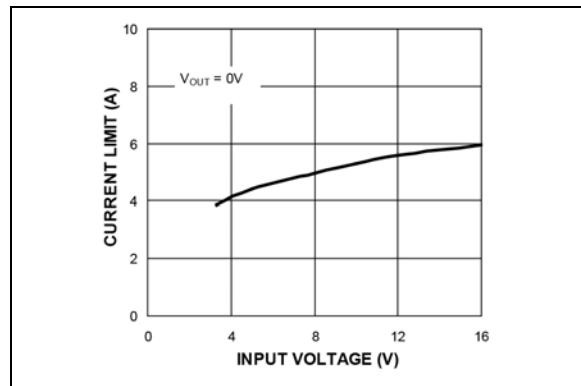

FIGURE 2-6: Short-Circuit Current vs. Input Voltage.

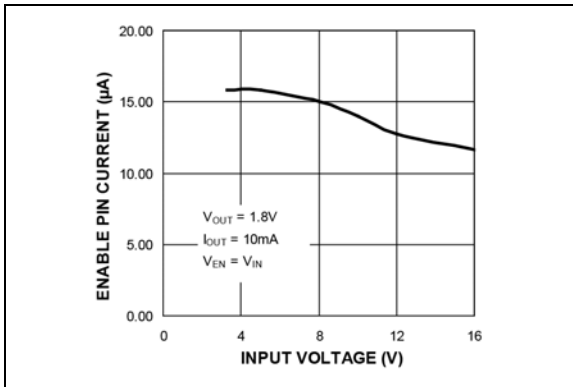

FIGURE 2-7: Enable Pin Current vs. Input Voltage.

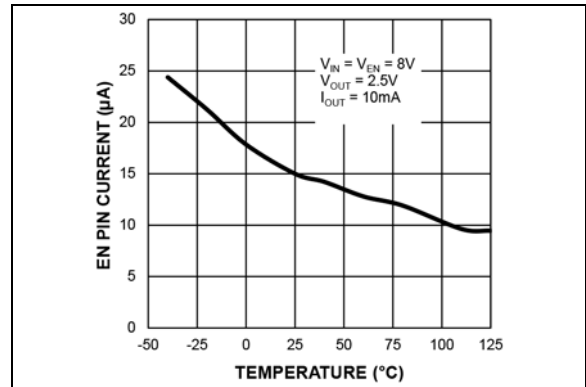

FIGURE 2-10: Enable Bias Current vs. Temperature.

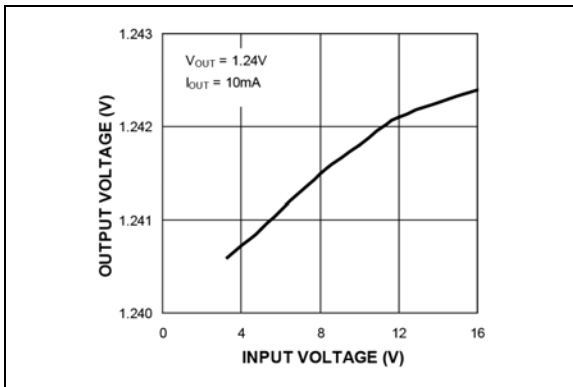

FIGURE 2-8: Output Voltage vs. Input Voltage.

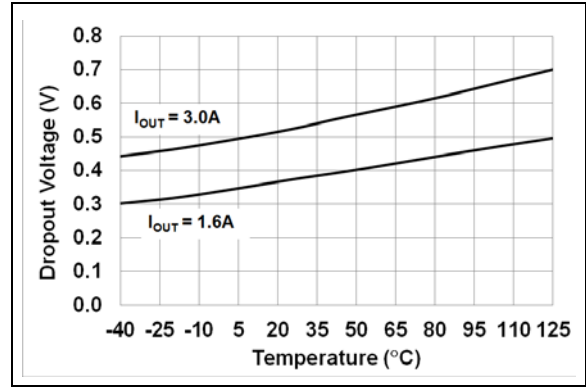

FIGURE 2-11: Dropout Voltage vs. Temperature.

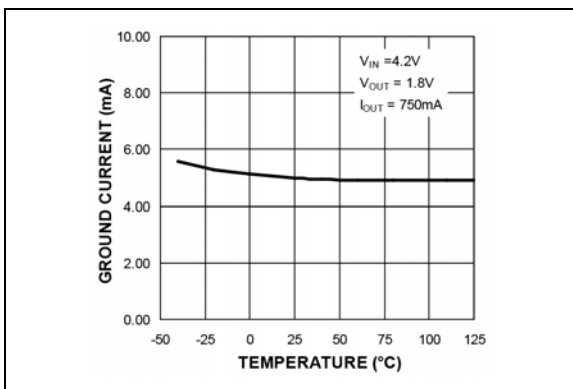

FIGURE 2-9: GND Pin Current vs. Temperature.

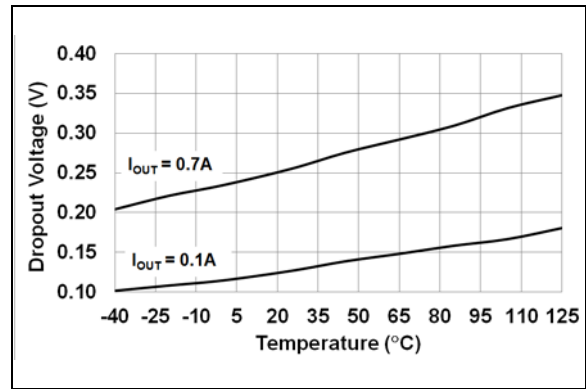

FIGURE 2-12: Dropout Voltage vs. Temperature.

MIC29302A

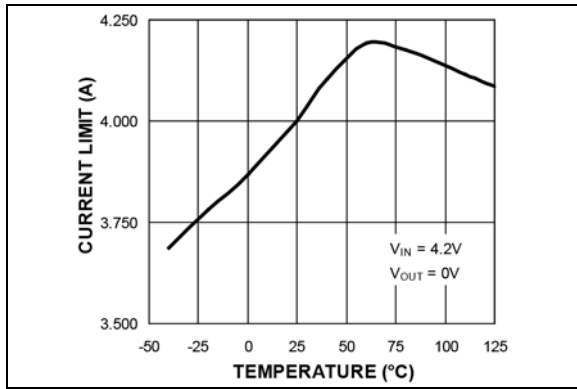

FIGURE 2-13: Short-Circuit Current vs. Temperature.

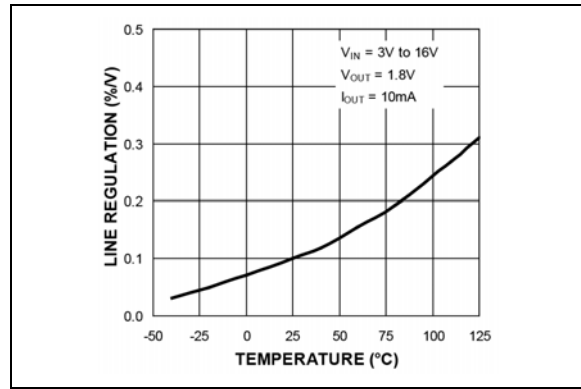

FIGURE 2-16: Line Regulation vs. Temperature.

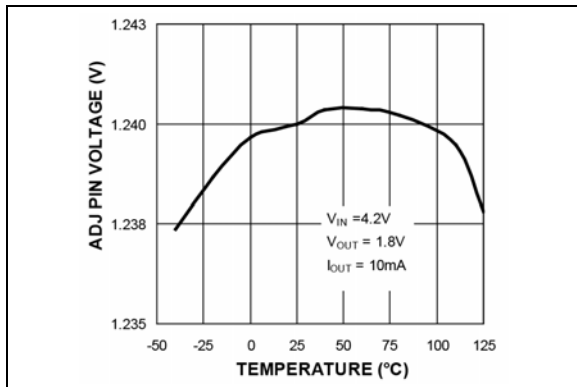

FIGURE 2-14: Adjust Pin Voltage vs. Temperature.

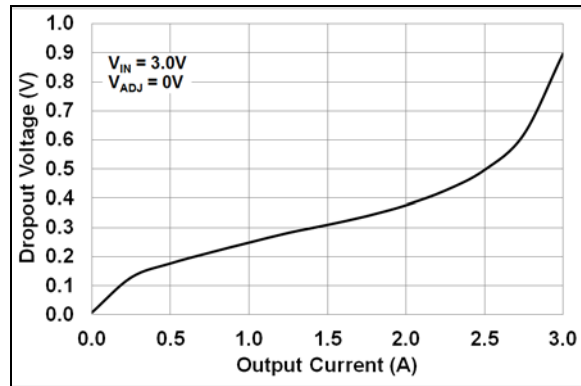

FIGURE 2-17: Dropout Voltage vs. Output Current.

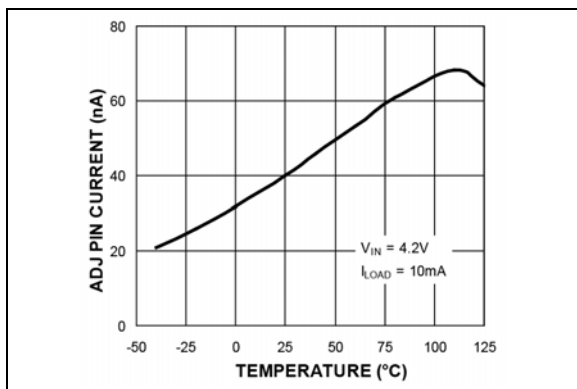

FIGURE 2-15: Adjust Pin Current vs. Temperature.

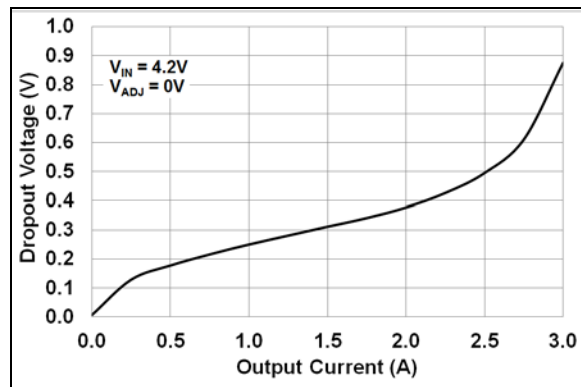

FIGURE 2-18: Dropout Voltage vs. Output Current.

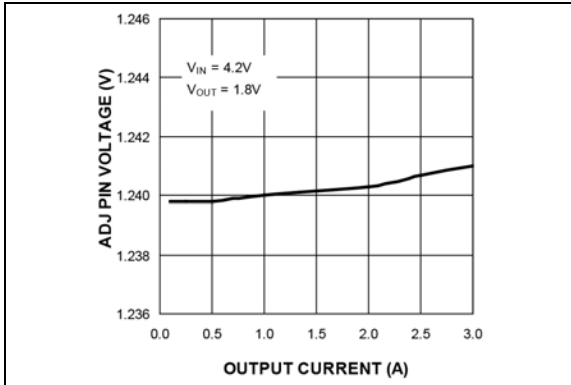

FIGURE 2-19: Adjust Pin Voltage vs. Output Current.

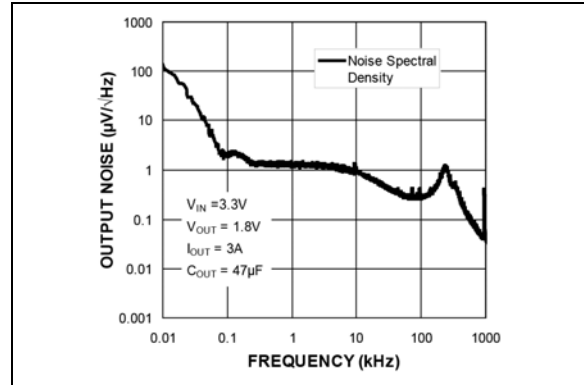

FIGURE 2-22: Output Noise vs. Frequency.

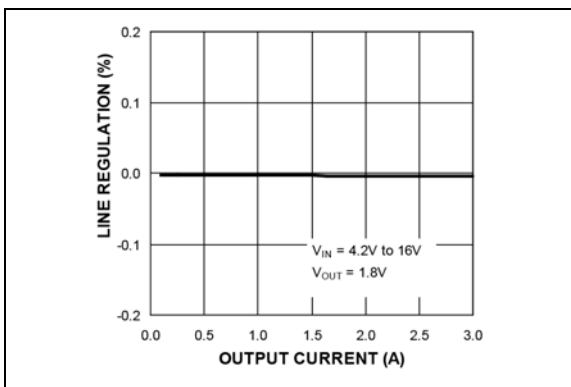

FIGURE 2-20: Line Regulation vs. Output Current.

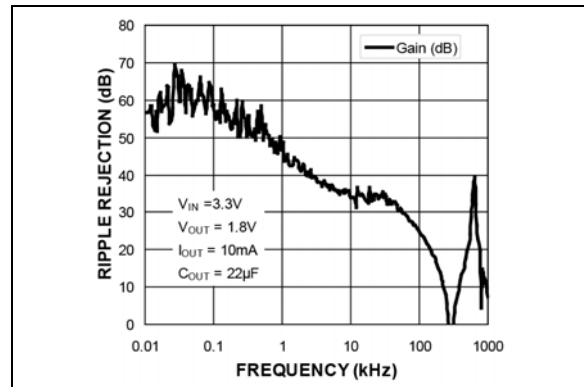

FIGURE 2-23: Ripple Rejection ($I_{OUT} = 10\text{ mA}$) vs. Frequency.

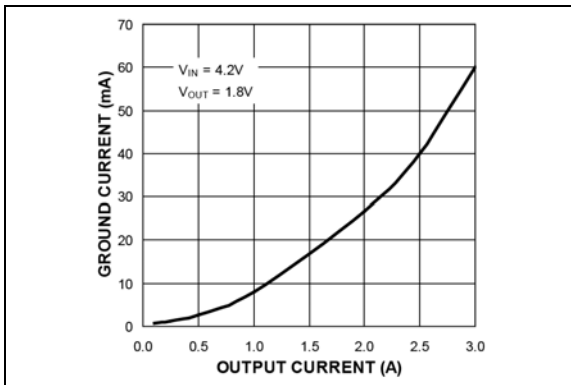

FIGURE 2-21: GND Pin Current vs. Output Current.

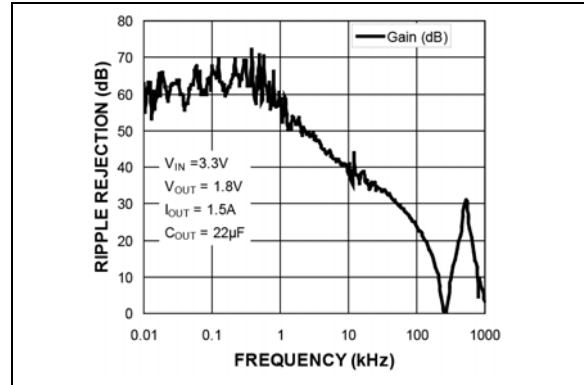

FIGURE 2-24: Ripple Rejection ($I_{OUT} = 1.5\text{ A}$) vs. Frequency.

MIC29302A

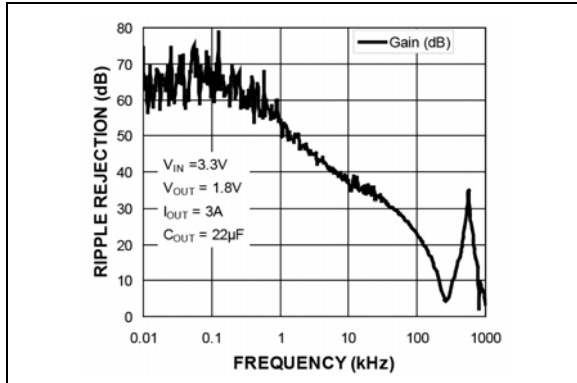

FIGURE 2-25: Ripple Rejection ($I_{OUT} = 3A$) vs. Frequency.

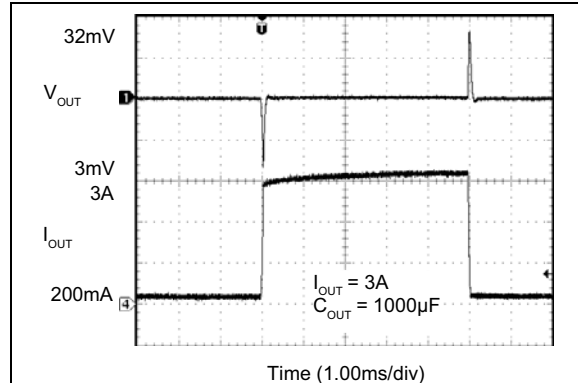

FIGURE 2-28: Line Transient Response with 3A Load, 10 μF Output Capacitance.

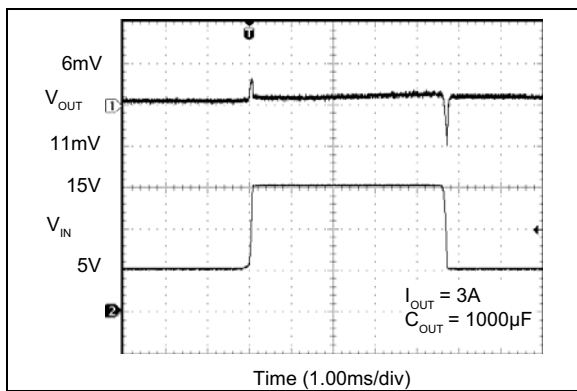

FIGURE 2-26: Line Transient Response with 3A Load, 1000 μF Output Capacitance.

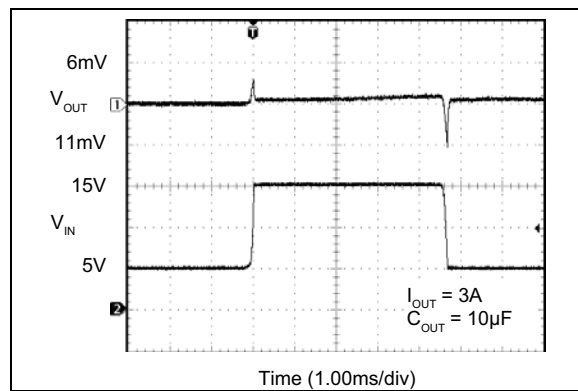

FIGURE 2-29: Load Transient Response with 3A Load, 1000 μF Output Capacitance.

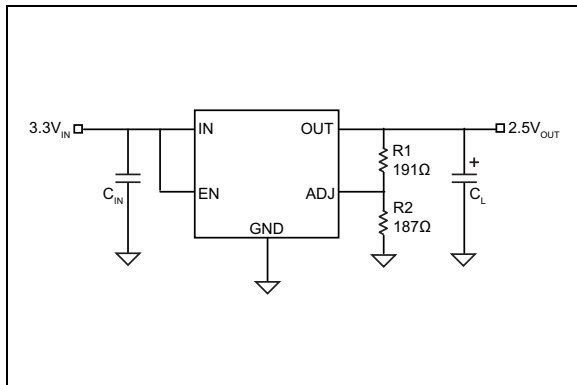

FIGURE 2-27: MIC29302A Load Transient Response Test Circuit.

3.0 PIN DESCRIPTIONS

The descriptions of the pins are listed in [Table 3-1](#).

TABLE 3-1: PIN FUNCTION TABLE

Pin Number TO-263	Pin Number TO-252	Pin Name	Description
1	1	EN	Enable (Input): Active-high TTL/CMOS-compatible control input. Do not float.
2	2	IN	INPUT: Unregulated input, +3V to +16V maximum.
3, TAB	3, TAB	GND	GND: TAB is also connected internally to the IC's ground on both packages.
4	4	OUT	OUTPUT: The regulator output voltage.
5	5	ADJ	Feedback Voltage: 1.24V feedback from external resistor divider.

MIC29302A

4.0 APPLICATION INFORMATION

The MIC29302A is a high-performance, low-dropout voltage regulator suitable for all moderate to high-current voltage regulation applications. Its 560 mV typical dropout voltage at full load makes it especially valuable in battery-powered systems and as high efficiency noise filters in post-regulator applications. Unlike older NPN-pass transistor designs, where the minimum dropout voltage is limited by the base-emitter voltage drop and collector-emitter saturation voltage, dropout performance of the PNP output is limited merely by the low V_{CE} saturation voltage.

A trade-off for the low dropout voltage is a varying base driver requirement. But the Super β PNP process reduces this drive requirement to merely 1% of the load current.

The MIC29302A regulator is fully protected from damage due to fault conditions. Current limiting is linear; output current under overload conditions is constant. Thermal shutdown disables the device when the die temperature exceeds the +125°C maximum safe operating temperature. The output structure of the regulators allows voltages in excess of the desired output voltage to be applied without reverse current flow. The MIC29302A offers a logic-level ON/OFF control. When disabled, the device draws 32 μ A at maximum 16V input.

4.1 Capacitor Requirements

For stability and minimum output noise, a capacitor on the regulator output is necessary. The value of this capacitor is dependent upon the output current; lower currents allow smaller capacitors. The MIC29302A is stable with a 10 μ F capacitor at full load.

This capacitor need not be an expensive low-ESR type; aluminum electrolytics are adequate. In fact, extremely low-ESR capacitors may contribute to instability. Tantalum capacitors are recommended for systems where fast load transient response is important.

When the regulator is powered from a source with high AC impedance, a 0.1 μ F capacitor connected between input and GND is recommended.

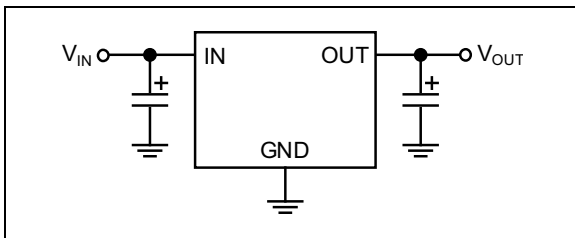

FIGURE 4-1: Linear Regulators Require Only Two Capacitors for Operation.

4.2 Transient Response and 5V to 3.3V Conversion

The MIC29302A has excellent response to variations in input voltage and load current. By virtue of its low dropout voltage, the device does not saturate into dropout as readily as similar NPN-based designs. A 3.3V output Microchip LDO will maintain full speed and performance with an input supply as low as 4.2V, and will still provide some regulation with supplies down to 3.8V, unlike NPN devices that require 5.1V or more for good performance and become nothing more than a resistor under 4.6V of input. Microchip's PNP regulators provide superior performance in "5V to 3.3V" conversion applications than NPN regulators, especially when all tolerances are considered.

4.3 Minimum Load Current

The MIC29302A regulator operates within a specified load range. If the output current is too small, leakage currents dominate and the output voltage rises.

A minimum load current of 10 mA is necessary for proper regulation and to swamp any expected leakage current across the operating temperature range.

For best performance the total resistance ($R1+R2$) should be small enough to pass the minimum regulator load current of 10 mA.

4.4 Adjustable Regulator Design

The output voltage can be programmed anywhere between 1.25V and the 15V. Two resistors are used. The resistor values are calculated by:

EQUATION 4-1:

$$R1 = R2 \times \left(\frac{V_{OUT}}{1.240} - 1 \right)$$

Where:

V_{OUT} = Desired output voltage.

Figure 4-2 shows component definition. Applications with widely varying load currents may scale the resistors to draw the minimum load current required for proper operation (see the [Minimum Load Current](#) section).

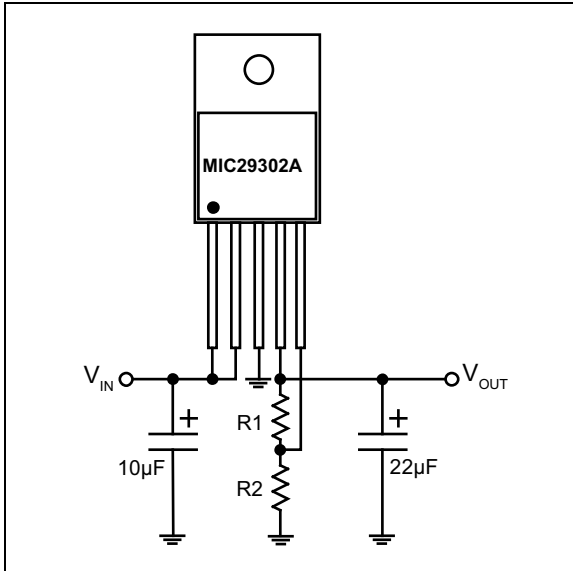

FIGURE 4-2: Adjustable Regulator with Resistors.

4.5 Enable Input

MIC29302A features an enable (EN) input that allows ON/OFF control of the device. The EN input has TTL/CMOS-compatible thresholds for simple interfacing with logic, or may be directly tied to V_{IN} . Enabling the regulator requires approximately 20 μA of current into the EN pin.

4.6 Thermal Design

Linear regulators are simple to use. The most complicated set of design parameters to consider are thermal characteristics. Thermal design requires the following application-specific parameters:

- Maximum Ambient Temperature, T_A
- Output Current, I_{OUT}
- Output Voltage, V_{OUT}
- Input Voltage, V_{IN}

First, calculate the power dissipation of the regulator from these numbers and the device parameters from this data sheet:

EQUATION 4-2:

$$P_D = I_{OUT}(1.05V_{IN} - V_{OUT})$$

Ground current is, in the worst case, 5% of I_{OUT} . Then the heatsink thermal resistance is determined with this formula:

EQUATION 4-3:

$$\theta_{SA} = \frac{T_{J(MAX)} - T_A}{P_D} - (\theta_{JC} + \theta_{CS})$$

Where:

$T_{J(MAX)}$ = Less than or equal to +125°C.

θ_{CS} = Between 0°C/W and 2°C/W.

θ_{JC} = Selected from Temperature Specifications table for selected package

The heatsink may be significantly increased in applications where the minimum input voltage is known and is large compared to the dropout voltage. A series input resistor can be used to drop excessive voltage and distribute the heat between this resistor and the regulator. The low-dropout properties of Microchip Super β PNP regulators allow very significant reductions in regulator power dissipation and the associated heatsink without compromising performance. When this technique is employed, a capacitor of at least 0.1 μF is needed directly between the input and regulator ground.

Please refer to Application Note 9 and Application Hint 17 on Microchip's website for further details and examples on thermal design and heatsink specification.

With no heatsink in the application, calculate the junction temperature to determine the maximum power dissipation that will be allowed before exceeding the maximum junction temperature of the MIC29302A. The maximum power allowed can be calculated using the thermal resistance (θ_{JA}) of the D-Pak (TO-252) adhering to the following criteria for the PCB design: 2 oz./ft.², meaning 70 μm thickness, copper and 100 mm² copper area for the MIC29302A.

For example, given an expected maximum ambient temperature (T_A) of +75°C with $V_{IN} = 3.3\text{V}$, $V_{OUT} = 2.5\text{V}$, and $I_{OUT} = 3\text{A}$, first calculate the expected P_D using [Equation 4-4](#).

MIC29302A

EQUATION 4-4:

$$P_D = 3.0A(1.05 \times 3.3V - 2.5V) = 2.9W$$

Next, calculate the junction temperature for the expected power dissipation:

EQUATION 4-5:

$$T_J = (\theta_{JA} \times P_D) + T_A = \\ (35^\circ C/W \times 2.9W) + 75^\circ C = 176.5^\circ C$$

Now determine the maximum power dissipation allowed that would not exceed the IC's maximum junction temperature (125°C) without the use of a heatsink by:

EQUATION 4-6:

$$P_{D(MAX)} = (T_{J(MAX)} - T_A) / \theta_{JA} \\ = (125^\circ C - 75^\circ C) / (35^\circ C/W) \\ = 1.428W$$

5.0 PACKAGING INFORMATION

5.1 Package Marking Information

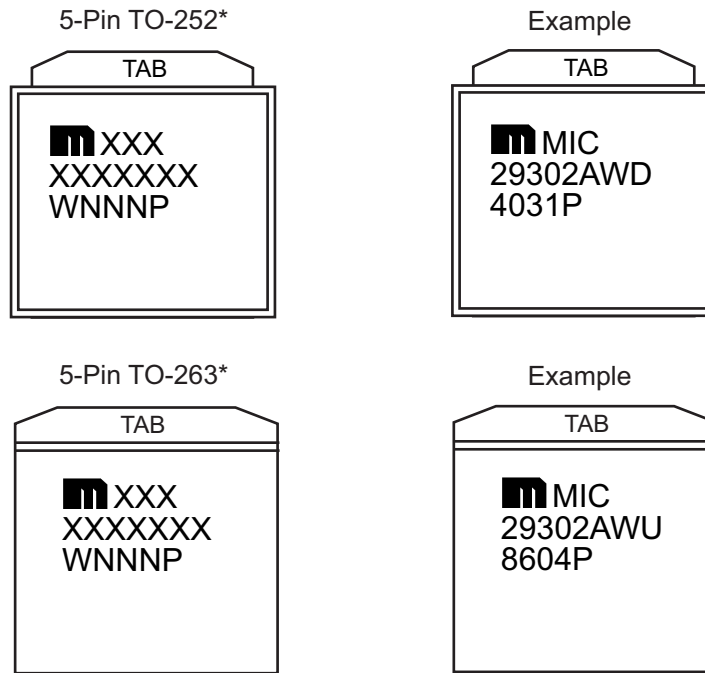

Legend:	XX...X	Product code or customer-specific information
	Y	Year code (last digit of calendar year)
	YY	Year code (last 2 digits of calendar year)
	WW	Week code (week of January 1 is week '01')
	NNN	Alphanumeric traceability code
	(e3)	Pb-free JEDEC® designator for Matte Tin (Sn)
	*	This package is Pb-free. The Pb-free JEDEC designator ((e3)) can be found on the outer packaging for this package.
	•, ▲, ▼	Pin one index is identified by a dot, delta up, or delta down (triangle mark).

Note: In the event the full Microchip part number cannot be marked on one line, it will be carried over to the next line, thus limiting the number of available characters for customer-specific information. Package may or may not include the corporate logo.

Underbar () and/or Overbar () symbol may not be to scale.

MIC29302A

5-Lead TO-252 Package Outline and Recommended Land Pattern

TITLE

5 LEAD TO252 PACKAGE OUTLINE & RECOMMENDED LAND PATTERN

DRAWING #	TO252-5LD-PL-1	UNIT	INCH/ MM
Lead Frame	Copper Alloy	Lead Finish	Matte Tin

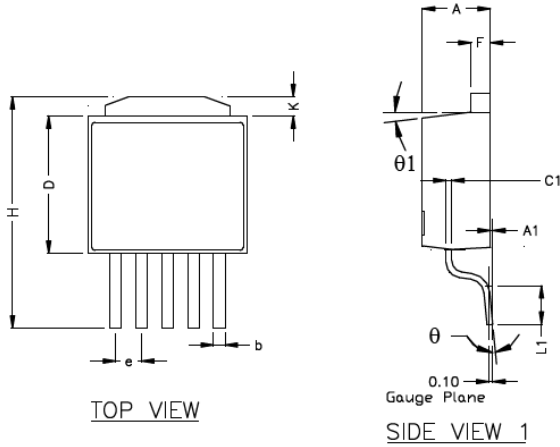

POS	INCH		MM	
	MIN	MAX	MIN	MAX
A	0.087	0.094	2.210	2.387
A1	0.000	0.012	0.000	0.305
b	0.023	0.026	0.584	0.660
C1	0.012	0.023	0.305	0.584
D	0.236	0.241	6.000	6.200
E	0.252	0.260	6.400	6.604
e	0.045	0.055	1.143	1.397
F	0.019	0.023	0.483	0.584
H	0.378	0.402	9.601	10.210
K	0.039	0.047	1.000	1.200
L1	0.055	0.065	1.397	1.651
theta	0°	8°	0°	8°
theta1	3°	10°	3°	10°
Q	0.055	0.075	1.397	1.905
U	0.206	Ref.	5.232	Ref.
V	0.213	Ref.	5.415	Ref.

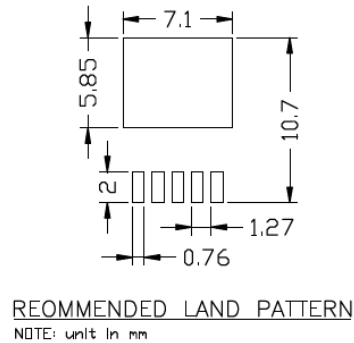
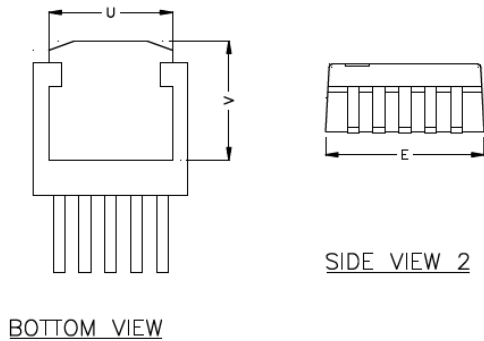

- NOTE:
1. PACKAGE OUTLINE EXCLUSIVE OF MOLD FLASH & METAL BURR.
 2. PACKAGE OUTLINE INCLUSIVE OF PLATING THICKNESS.
 3. FOOT LENGTH USING GAUGE PLANE METHOD MEASUREMENT 0.010"
 4. ALL DIMENSIONS ARE IN INCHES/MILLIMETERS.

Note: For the most current package drawings, please see the Microchip Packaging Specification located at <http://www.microchip.com/packaging>.

5-Lead TO-263 Package Outline and Recommended Land Pattern

TITLE

5 LEAD T0263 PACKAGE OUTLINE & RECOMMENDED LAND PATTERN

DRAWING # T0263-5LD-PL-1

UNIT INCH/MM

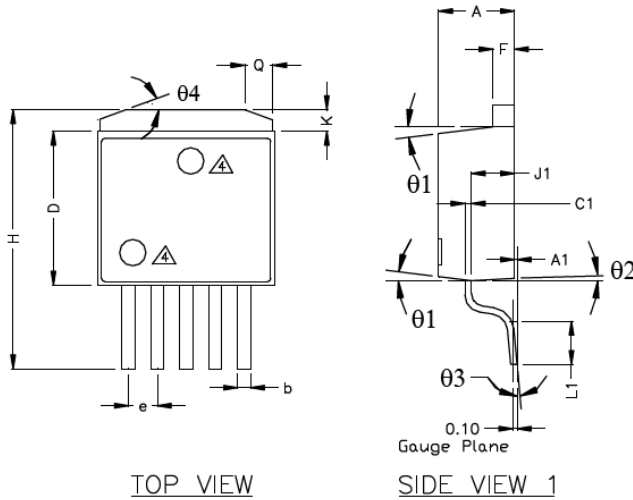

TOP VIEW

SIDE VIEW 1

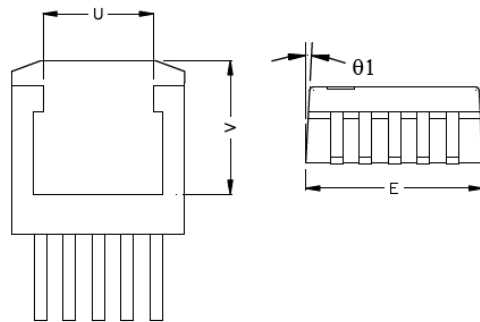

BOTTOM VIEW

SIDE VIEW 2

POS	INCH		MM	
	MIN	MAX	MIN	MAX
A	0.170	0.181	4.318	4.597
A1	0.000	0.012	0.000	0.305
b	0.026	0.036	0.660	0.914
C1	0.012	0.023	0.305	0.584
D	0.330	0.361	8.392	9.169
E	0.396	0.420	10.058	10.668
e	0.062	0.072	1.575	1.829
F	0.045	0.055	1.143	1.397
H	0.575	0.625	14.605	15.875
J1	0.080	0.120	2.032	3.048
K	0.045	0.066	1.143	1.676
L1	0.090	0.110	2.286	2.794
theta 1	3°	10°	3°	10°
theta 2	1°	7°	1°	7°
theta 3	0°	8°	0°	8°
theta 4	18°	22°	18°	22°
Q	0.055	0.075	1.397	1.905
U	0.256 Ref.		6.502 Ref.	
V	0.305 Ref.		7.747 Ref.	

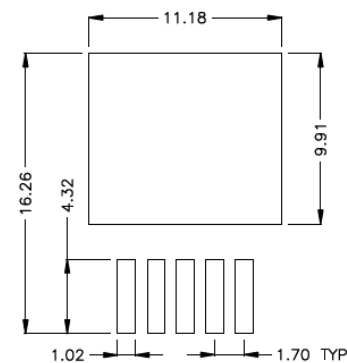

RECOMMENDED LAND PATTERN
(UNIT : mm)

NOTE:

1. PACKAGE OUTLINE EXCLUSIVE OF MOLD FLASH & METAL BURR.
2. PACKAGE OUTLINE INCLUSIVE OF PLATING THICKNESS.
3. FOOT LENGTH USING GAUGE PLANE METHOD MEASUREMENT 0.010"
4. PACKAGE TOP MARK MAY BE IN TOP CENTER OR LOWER LEFT CORNER
5. ALL DIMENSIONS ARE IN INCHES/MILLIMETERS.

Note: For the most current package drawings, please see the Microchip Packaging Specification located at <http://www.microchip.com/packaging>.

MIC29302A

NOTES:

APPENDIX A: REVISION HISTORY

Revision A (November 2017)

- Converted Micrel document MIC29302A to Microchip data sheet DS20005897A.
- Minor text changes throughout.
- Updated the list of [Features](#).
- Updated values and notes in [Table 1-1](#).
- Rearranged sub-sections and revised values in [Application Information](#) section to improve clarity.

Revision B (January 2018)

- Updated Current Limit values in [Table 1-1](#).

MIC29302A

NOTES:

PRODUCT IDENTIFICATION SYSTEM

To order or obtain information, e.g., on pricing or delivery, contact your local Microchip representative or sales office.

<u>PART NO.</u>	X	X	X	-XX
Device	Output Voltage	Junction Temp. Range	Package	Media Type
Device:	MIC29302A:	3A Fast Response LDO Regulator		
Output Voltage:	<blank>=	Adjustable		
Junction Temperature Range:	W =	-40°C to +125°C, RoHS-Compliant*		
Package:	D =	5-Lead D-Pak (TO-252)		
	U =	5-Lead D ² Pak (TO-263)		
Media Type:	<blank>=	80/Tube (TO-252 Package)		
	TR =	2,500/Reel (TO-252 Package)		
	<blank>=	50/Tube (TO-263 Package)		
	TR =	750/Reel (TO-263 Package)		

* RoHS-Compliant with "high melting solder" exemption.

Examples:

- a) MIC29302AWD: 3A Fast Response LDO Regulator, Adjustable Voltage Option, -40°C to +125°C Junction Temperature Range, RoHS-Compliant*, 5-Lead D-PAK (TO-252) package, 80/Tube
- b) MIC29302AWU: 3A Fast Response LDO Regulator, Adjustable Voltage Option, -40°C to +125°C Junction Temperature Range, RoHS-Compliant*, 5-Lead D²PAK (TO-263) package, 50/Tube
- c) MIC29302AWD-TR: 3A Fast Response LDO Regulator, Adjustable Voltage Option, -40°C to +125°C Junction Temperature Range, RoHS-Compliant*, 5-Lead D-PAK (TO-252) package, 2,500/Reel
- d) MIC29302AWU-TR: 3A Fast Response LDO Regulator, Adjustable Voltage Option, -40°C to +125°C Junction Temperature Range, RoHS-Compliant*, 5-Lead D²PAK (TO-263) package, 750/Reel

Note 1: Tape and Reel identifier only appears in the catalog part number description. This identifier is used for ordering purposes and is not printed on the device package. Check with your Microchip Sales Office for package availability with the Tape and Reel option.

MIC29302A

NOTES:

Note the following details of the code protection feature on Microchip devices:

- Microchip products meet the specification contained in their particular Microchip Data Sheet.
- Microchip believes that its family of products is one of the most secure families of its kind on the market today, when used in the intended manner and under normal conditions.
- There are dishonest and possibly illegal methods used to breach the code protection feature. All of these methods, to our knowledge, require using the Microchip products in a manner outside the operating specifications contained in Microchip's Data Sheets. Most likely, the person doing so is engaged in theft of intellectual property.
- Microchip is willing to work with the customer who is concerned about the integrity of their code.
- Neither Microchip nor any other semiconductor manufacturer can guarantee the security of their code. Code protection does not mean that we are guaranteeing the product as “unbreakable.”

Code protection is constantly evolving. We at Microchip are committed to continuously improving the code protection features of our products. Attempts to break Microchip's code protection feature may be a violation of the Digital Millennium Copyright Act. If such acts allow unauthorized access to your software or other copyrighted work, you may have a right to sue for relief under that Act.

Information contained in this publication regarding device applications and the like is provided only for your convenience and may be superseded by updates. It is your responsibility to ensure that your application meets with your specifications. MICROCHIP MAKES NO REPRESENTATIONS OR WARRANTIES OF ANY KIND WHETHER EXPRESS OR IMPLIED, WRITTEN OR ORAL, STATUTORY OR OTHERWISE, RELATED TO THE INFORMATION, INCLUDING BUT NOT LIMITED TO ITS CONDITION, QUALITY, PERFORMANCE, MERCHANTABILITY OR FITNESS FOR PURPOSE. Microchip disclaims all liability arising from this information and its use. Use of Microchip devices in life support and/or safety applications is entirely at the buyer's risk, and the buyer agrees to defend, indemnify and hold harmless Microchip from any and all damages, claims, suits, or expenses resulting from such use. No licenses are conveyed, implicitly or otherwise, under any Microchip intellectual property rights unless otherwise stated.

Microchip received ISO/TS-16949:2009 certification for its worldwide headquarters, design and wafer fabrication facilities in Chandler and Tempe, Arizona; Gresham, Oregon and design centers in California and India. The Company's quality system processes and procedures are for its PIC® MCUs and dsPIC® DSCs, KEELoQ® code hopping devices, Serial EEPROMs, microperipherals, nonvolatile memory and analog products. In addition, Microchip's quality system for the design and manufacture of development systems is ISO 9001:2000 certified.

**QUALITY MANAGEMENT SYSTEM
CERTIFIED BY DNV
= ISO/TS 16949 =**

Trademarks

The Microchip name and logo, the Microchip logo, AnyRate, AVR, AVR logo, AVR Freaks, BeaconThings, BitCloud, CryptoMemory, CryptoRF, dsPIC, FlashFlex, flexPWR, Heldo, JukeBlox, KEELoQ, KEELoQ logo, Klear, LANCheck, LINK MD, maXStylus, maXTouch, MediaLB, megaAVR, MOST, MOST logo, MPLAB, OptoLyzer, PIC, picoPower, PICSTART, PIC32 logo, Prochip Designer, QTouch, RightTouch, SAM-BA, SpyNIC, SST, SST Logo, SuperFlash, tinyAVR, UNI/O, and XMEGA are registered trademarks of Microchip Technology Incorporated in the U.S.A. and other countries.

ClockWorks, The Embedded Control Solutions Company, EtherSynch, Hyper Speed Control, HyperLight Load, IntelliMOS, mTouch, Precision Edge, and Quiet-Wire are registered trademarks of Microchip Technology Incorporated in the U.S.A.

Adjacent Key Suppression, AKS, Analog-for-the-Digital Age, Any Capacitor, AnyIn, AnyOut, BodyCom, chipKIT, chipKIT logo, CodeGuard, CryptoAuthentication, CryptoCompanion, CryptoController, dsPICDEM, dsPICDEM.net, Dynamic Average Matching, DAM, ECAN, EtherGREEN, In-Circuit Serial Programming, ICSP, Inter-Chip Connectivity, JitterBlocker, KlearNet, KlearNet logo, Mindi, MiWi, motorBench, MPASM, MPF, MPLAB Certified logo, MPLIB, MPLINK, MultiTRAK, NetDetach, Omniscient Code Generation, PICDEM, PICDEM.net, PICKit, PICtail, PureSilicon, QMatrix, RightTouch logo, REAL ICE, Ripple Blocker, SAM-ICE, Serial Quad I/O, SMART-I.S., SQI, SuperSwitcher, SuperSwitcher II, Total Endurance, TSHARC, USBCheck, VariSense, ViewSpan, WiperLock, Wireless DNA, and ZENA are trademarks of Microchip Technology Incorporated in the U.S.A. and other countries.

SQTP is a service mark of Microchip Technology Incorporated in the U.S.A.

Silicon Storage Technology is a registered trademark of Microchip Technology Inc. in other countries.

GestIC is a registered trademark of Microchip Technology Germany II GmbH & Co. KG, a subsidiary of Microchip Technology Inc., in other countries.

All other trademarks mentioned herein are property of their respective companies.

© 2018, Microchip Technology Incorporated, All Rights Reserved.
ISBN: 978-1-5224-2606-6



MICROCHIP

Worldwide Sales and Service

AMERICAS

Corporate Office
2355 West Chandler Blvd.
Chandler, AZ 85224-6199
Tel: 480-792-7200
Fax: 480-792-7277
Technical Support:
<http://www.microchip.com/support>
Web Address:
www.microchip.com

Atlanta

Duluth, GA
Tel: 678-957-9614
Fax: 678-957-1455

Austin, TX

Tel: 512-257-3370

Boston

Westborough, MA
Tel: 774-760-0087
Fax: 774-760-0088

Chicago

Itasca, IL
Tel: 630-285-0071
Fax: 630-285-0075

Dallas

Addison, TX
Tel: 972-818-7423
Fax: 972-818-2924

Detroit

Novi, MI
Tel: 248-848-4000

Houston, TX

Tel: 281-894-5983

Indianapolis

Noblesville, IN
Tel: 317-773-8323
Fax: 317-773-5453
Tel: 317-536-2380

Los Angeles

Mission Viejo, CA
Tel: 949-462-9523
Fax: 949-462-9608
Tel: 951-273-7800

Raleigh, NC

Tel: 919-844-7510

New York, NY

Tel: 631-435-6000

San Jose, CA

Tel: 408-735-9110
Tel: 408-436-4270

Canada - Toronto

Tel: 905-695-1980
Fax: 905-695-2078

ASIA/PACIFIC

Australia - Sydney
Tel: 61-2-9868-6733

China - Beijing
Tel: 86-10-8569-7000

China - Chengdu
Tel: 86-28-8665-5511

China - Chongqing
Tel: 86-23-8980-9588

China - Dongguan
Tel: 86-769-8702-9880

China - Guangzhou
Tel: 86-20-8755-8029

China - Hangzhou
Tel: 86-571-8792-8115

China - Hong Kong SAR
Tel: 852-2943-5100

China - Nanjing
Tel: 86-25-8473-2460

China - Qingdao
Tel: 86-532-8502-7355

China - Shanghai
Tel: 86-21-3326-8000

China - Shenyang
Tel: 86-24-2334-2829

China - Shenzhen
Tel: 86-755-8864-2200

China - Suzhou
Tel: 86-186-6233-1526

China - Wuhan
Tel: 86-27-5980-5300

China - Xian
Tel: 86-29-8833-7252

China - Xiamen
Tel: 86-592-2388138

China - Zhuhai
Tel: 86-756-3210040

ASIA/PACIFIC

India - Bangalore
Tel: 91-80-3090-4444

India - New Delhi
Tel: 91-11-4160-8631

India - Pune
Tel: 91-20-4121-0141

Japan - Osaka
Tel: 81-6-6152-7160

Japan - Tokyo
Tel: 81-3-6880-3770

Korea - Daegu
Tel: 82-53-744-4301

Korea - Seoul
Tel: 82-2-554-7200

Malaysia - Kuala Lumpur
Tel: 60-3-7651-7906

Malaysia - Penang
Tel: 60-4-227-8870

Philippines - Manila
Tel: 63-2-634-9065

Singapore
Tel: 65-6334-8870

Taiwan - Hsin Chu
Tel: 886-3-577-8366

Taiwan - Kaohsiung
Tel: 886-7-213-7830

Taiwan - Taipei
Tel: 886-2-2508-8600

Thailand - Bangkok
Tel: 66-2-694-1351

Vietnam - Ho Chi Minh
Tel: 84-28-5448-2100

EUROPE

Austria - Wels
Tel: 43-7242-2244-39
Fax: 43-7242-2244-393

Denmark - Copenhagen
Tel: 45-4450-2828
Fax: 45-4485-2829

Finland - Espoo
Tel: 358-9-4520-820

France - Paris
Tel: 33-1-69-53-63-20
Fax: 33-1-69-30-90-79

Germany - Garching
Tel: 49-8931-9700

Germany - Haan
Tel: 49-2129-3766400

Germany - Heilbronn
Tel: 49-7131-67-3636

Germany - Karlsruhe
Tel: 49-721-625370

Germany - Munich
Tel: 49-89-627-144-0
Fax: 49-89-627-144-44

Germany - Rosenheim
Tel: 49-8031-354-560

Israel - Ra'anana
Tel: 972-9-744-7705

Italy - Milan
Tel: 39-0331-742611
Fax: 39-0331-466781

Italy - Padova
Tel: 39-049-7625286

Netherlands - Drunen
Tel: 31-416-690399
Fax: 31-416-690340

Norway - Trondheim
Tel: 47-7289-7561

Poland - Warsaw
Tel: 48-22-3325737

Romania - Bucharest
Tel: 40-21-407-87-50

Spain - Madrid
Tel: 34-91-708-08-90
Fax: 34-91-708-08-91

Sweden - Gothenberg
Tel: 46-31-704-60-40

Sweden - Stockholm
Tel: 46-8-5090-4654

UK - Wokingham
Tel: 44-118-921-5800
Fax: 44-118-921-5820