

## 500 mA Synchronous BUCK Regulator

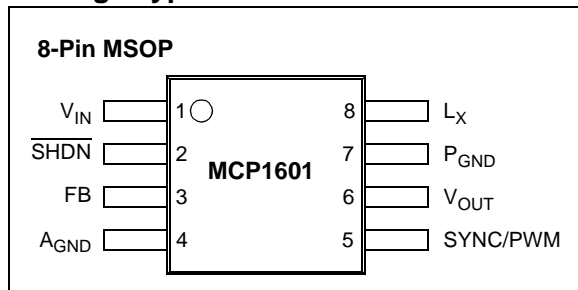
### Features

- Input Range of 2.7V to 5.5V
- 3 Operating Modes: PWM, PFM and LDO
- Integrated BUCK and Synchronous Switches
- Ceramic or Electrolytic Input/Output Filtering Capacitors
- 750 kHz Fixed Switching Frequency
- Oscillator Synchronization to 1 MHz PWM Mode
- Auto-Switching from PWM/PFM Operation
- 100% Duty Cycle Capable for Low Input Voltage
- 500 mA Continuous Output Current Capability
- Integrated Under-Voltage Lock-Out Protection
- Integrated Over-Temperature Protection
- Integrated Soft Start Circuitry
- Low Output Voltage Capability to 0.9V
- Temperature Range: -40°C to +85°C
- Small 8-Pin MSOP Package

### Applications

- Low Power Handheld CPUs and DSPs
- Cellular Phones
- Organizers and PDAs
- Digital Cameras
- +5V or +3.3V Distributed Voltages
- USB Powered Devices

### Package Type



### Description

The MCP1601 is a fully integrated synchronous BUCK (step down) DC/DC converter for battery powered systems. With an input operating range of 2.7V to 5.5V, the MCP1601 is ideal for applications being powered by one single cell Li-Ion, 2 to 3 cell NiMH, NiCd or alkaline sources. Output voltages can range from 0.9V to V<sub>IN</sub> to accommodate a wide range of applications. Efficiency can exceed 92% while operating at 750 kHz with load current capability up to 500 mA. The MCP1601 is used to minimize space, cost and wasted energy.

The PWM mode switching frequency is internally set to a fixed 750 kHz allowing the use of low profile, surface mount inductors and ceramic capacitors while maintaining a typical efficiency of 92%.

The MCP1601 is capable of three distinct operating modes: PWM, PFM and Low Drop Out.

When operating in PWM (pulse width modulation) mode, the DC/DC converter switches at a single high frequency determined by either the internal 750 kHz oscillator or external synchronization frequency.

For applications that operate at very light to no load for extended periods of time, the MCP1601 is capable of operating in PFM (pulse frequency modulation mode) to reduce the number of switching cycles/sec and consume less energy.

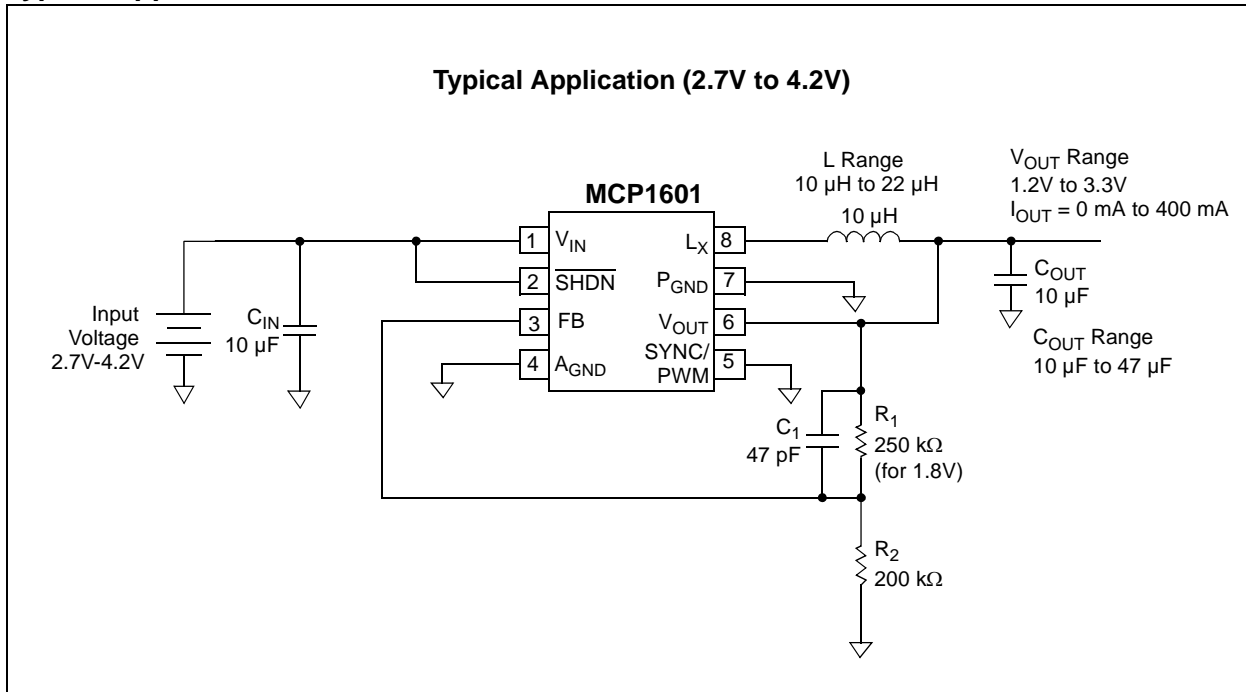
The third mode of operation (LDO mode) occurs when the input voltage approaches the output voltage and the BUCK duty cycle approaches 100%. The MCP1601 will enter a low drop out mode and the high-side P-Channel BUCK switch will saturate, providing the output with the maximum voltage possible.

The MCP1601 has integrated over-current protection, over-temperature protection and UVLO (Under Voltage Lockout) to provide for a fail safe solution with no external components.

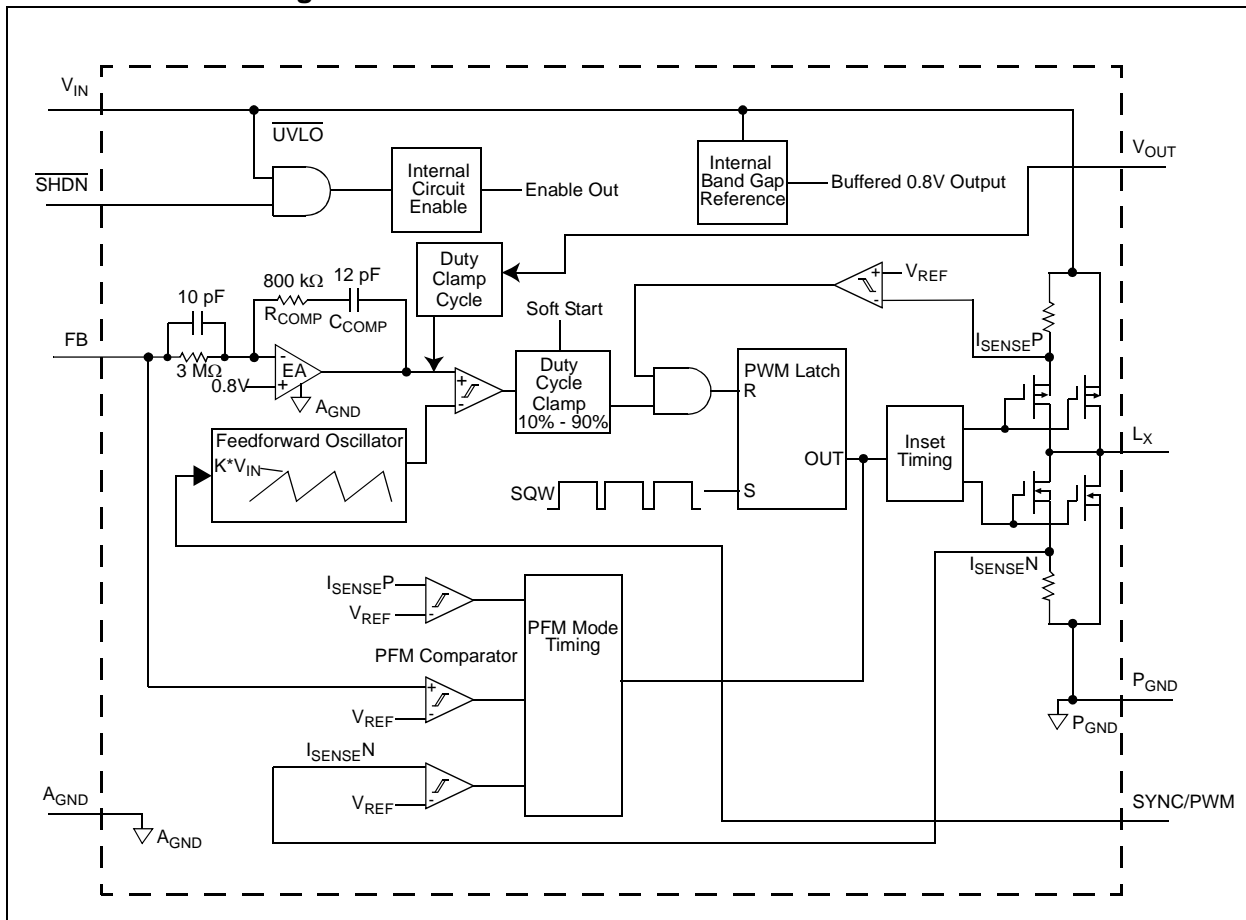
The MCP1601 is available in the 8-pin MSOP package, with an operating temperature range of -40°C to +85°C.

# MCP1601

## Typical Application



## Functional Block Diagram



## 1.0 ELECTRICAL CHARACTERISTICS

### Absolute Maximum Ratings †

$V_{IN} - A_{GND}$ .....	6.0V
SHDN, FB, SYNC/PWM, $V_{OUT}$ ..... ( $A_{GND}-0.3V$ ) to ( $V_{IN}+0.3V$ )	
$L_X$ to $P_{GND}$ .....	-0.3V to ( $V_{IN}+0.3V$ )
$P_{GND}$ to $A_{GND}$ .....	-0.3V to +0.3V
Output Short Circuit Current .....	continuous
Storage temperature .....	-65°C to +150°C
Ambient Temp. with Power Applied .....	-40°C to +85°C
Operating Junction Temperature.....	-40°C to +125°C
ESD protection on all pins.....	$\geq 4$ kV

† **Notice:** Stresses above those listed under "Maximum ratings" may cause permanent damage to the device. This is a stress rating only and functional operation of the device at those or any other conditions above those indicated in the operational listings of this specification is not implied. Exposure to maximum rating conditions for extended periods may affect device reliability.

## PIN FUNCTION TABLE

NAME	FUNCTION
$V_{IN}$	Input Source Voltage
SHDN	Device Shutdown Pin
FB	Output Voltage Feedback Input
$A_{GND}$	Analog Ground
$V_{OUT}$	Sensed Output Voltage
SYNC/PWM	Synchronous Clock input or PWM/PFM select
$P_{GND}$	Power Ground
$L_X$	Output Inductor Node

## ELECTRICAL SPECIFICATIONS

Electrical Specifications: Unless otherwise indicated, $V_{IN}=4.2V$ , $V_{OUT}=1.8V$ , $I_{LOAD} = 10$ mA, $T_A=-40^\circ C$ to $+85^\circ C$ .						
Parameters	Sym	Min	Typ	Max	Units	Conditions
<b>Power Input Requirements</b>						
Voltage	$V_{IN}$	2.7	—	5.5	V	$I_{LOAD} = 0$ mA to 500 mA
Shutdown Current	$I(V_{IN})$	—	0.05	1.0	$\mu A$	Shutdown Mode ( $\overline{SHDN} = GND$ )
PFM Mode Current	$I(V_{IN})$	—	119	180	$\mu A$	SYNC/PWM = GND, PFM Mode ( $I_{LOAD} = 0$ mA)
<b>Oscillator Section</b>						
Internal Oscillator Frequency	$F_{OSC}$	650	750	850	kHz	SYNC/PWM = $V_{IN}$
External Oscillator Capture Range	$F_{SYNC}$	850	—	1000	kHz	$F_{SYNC} > F_{OSC}$
External Oscillator Duty Cycle	$F_{SYN-FALL}$	10	—	90	%	$F_{SYNC} = 1$ MHz
<b>Internal Power Switches</b>						
$R_{DSon}$ P-CHANNEL	$R_{DSon-P}$	—	500	—	m $\Omega$	$I_P=100$ mA, $T_A=+25^\circ C$ , $V_{IN}=4.2V$
$R_{DSon}$ N-CHANNEL	$R_{DSon-N}$	—	500	—	m $\Omega$	$I_N=100$ mA, $T_A=+25^\circ C$ , $V_{IN}=4.2V$
Dropout Voltage	$V_{DROPOUT}$	—	250	—	mV	$V_{OUT} = 2.7V$ , $I_{LOAD} = 300$ mA, $T_A=+25^\circ C$ , $V_{DROPOUT}=97\%V_{OUT}$
Pin Leakage Current	$I_{LX}$	-1.0	—	1.0	$\mu A$	$\overline{SHDN} = 0V$ , $V_{IN} = 5.5V$ , $L_X = 0V$ , $L_X = 5.5V$
<b>Output PWM Mode</b>						
Peak Current Limit	$I_{PEAK-PWM}$	—	1.0	—	A	PWM Mode, SYNC/PWM = $V_{IN}$ , $T_A = +25^\circ C$
<b>Output Voltage</b>						
Output Voltage Range	$V_{OUT}$	0.9	—	$V_{IN}$	V	
Reference Feedback Voltage	$V_{FB}$	0.78	0.8	0.82	V	
Feedback Input Bias Current	$I_{VFB}$	—	0.1	—	nA	
Line Regulation	$V_{LINE-REG}$	—	0.1	—	%/V	$V_{IN}=2.7V$ to $5.5V$ , $I_{LOAD}=10$ mA
Load Regulation	$V_{LOAD-REG}$	—	1.5	—	%	$V_{IN} = 3.6V$ , $I_{LOAD} = 0$ mA to 300 mA
Start-Up Time	$T_{START}$	—	0.5	—	ms	PWM Mode, SYNC/PWM= $V_{IN}$

# MCP1601

## ELECTRICAL SPECIFICATIONS (CONTINUED)

Electrical Specifications: Unless otherwise indicated, $V_{IN}=4.2V$ , $V_{OUT}=1.8V$ , $I_{LOAD} = 10\text{ mA}$ , $T_A=-40^{\circ}\text{C}$ to $+85^{\circ}\text{C}$ .						
Parameters	Sym	Min	Typ	Max	Units	Conditions
<b>Protection Features</b>						
Average Short Circuit Current		—	890	—	mA	$R_{LOAD} < 1\text{ ohm}$
Under-Voltage Lockout	UVLO	2.4	—	2.7	V	For $V_{IN}$ decreasing
Under-Voltage Lockout Hysteresis	UVLO <sub>HYS</sub>	—	190	—	mV	
Thermal Shutdown	$T_{SHD}$	—	160	—	$^{\circ}\text{C}$	
Thermal Shutdown Hysteresis	$T_{SHD-HYS}$	—	10	—	$^{\circ}\text{C}$	
<b>Interface Signals (SHDN, SYNC/PWM)</b>						
Logic Low Input	$V_{IN-HIGH}$	—	—	15	% of $V_{IN}$	
Logic High Input	$V_{IN-HIGH}$	45	—	—	% of $V_{IN}$	
Input Leakage Current	$I_{IN-LK}$	—	—	0.1	$\mu\text{A}$	

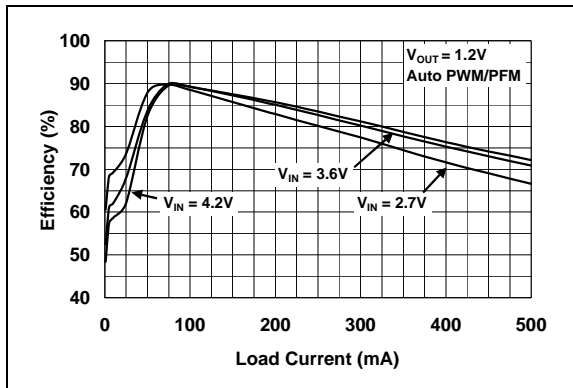
## TEMPERATURE SPECIFICATIONS

Electrical Specifications: Unless otherwise noted, all parameters apply at $V_{DD} = 2.7V$ to $5.5V$						
Parameters	Symbol	Min	Typ	Max	Units	Conditions
<b>Temperature Ranges</b>						
Specified Temperature Range	$T_A$	-40	—	+85	$^{\circ}\text{C}$	
Operating Junction Temperature Range	$T_J$	-40	—	+125	$^{\circ}\text{C}$	
Storage Temperature Range	$T_A$	-65	—	+150	$^{\circ}\text{C}$	
<b>Thermal Package Resistances</b>						
Thermal Resistance, 8 Pin MSOP	$\theta_{JA}$	—	208	—	$^{\circ}\text{C}/\text{W}$	Single-Layer SEMI G42-88 Board, Natural Convection

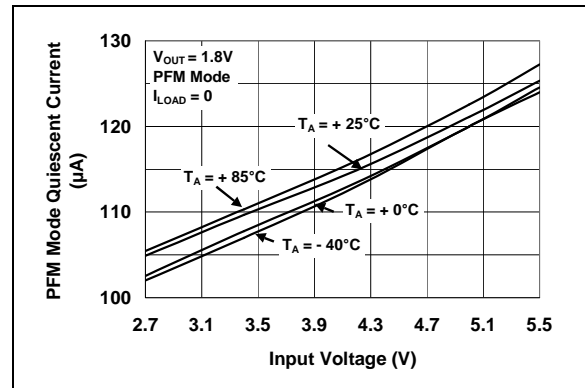
## 2.0 TYPICAL PERFORMANCE CURVES

**Note:** The graphs and tables provided following this note are a statistical summary based on a limited number of samples and are provided for informational purposes only. The performance characteristics listed herein are not tested or guaranteed. In some graphs or tables, the data presented may be outside the specified operating range (e.g., outside specified power supply range) and therefore outside the warranted range.

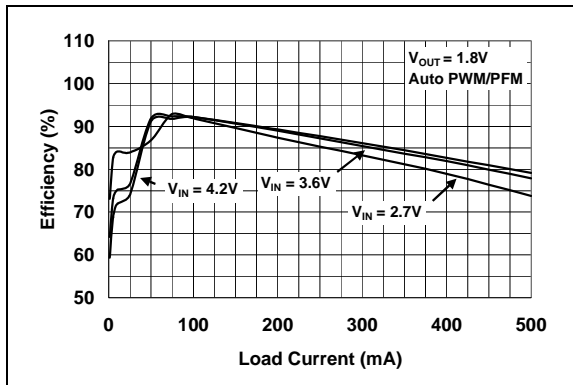
**Note:** Unless otherwise indicated,  $V_{IN} = 4.2V$ ,  $V_{OUT} = 1.8V$ ,  $L = 10 \mu H$ ,  $C_{OUT} = 10 \mu F$  (X5R Ceramic),  $C_{IN} = 10 \mu F$  (X5R Ceramic),  $SYNC/PWM = V_{IN}$ .



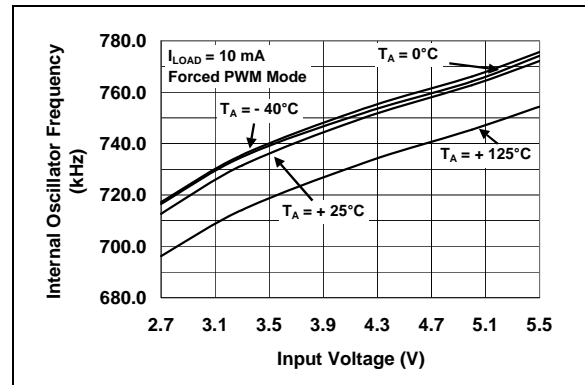
**FIGURE 2-1:** Efficiency vs. Load Current ( $V_{OUT} = 1.2V$ ).



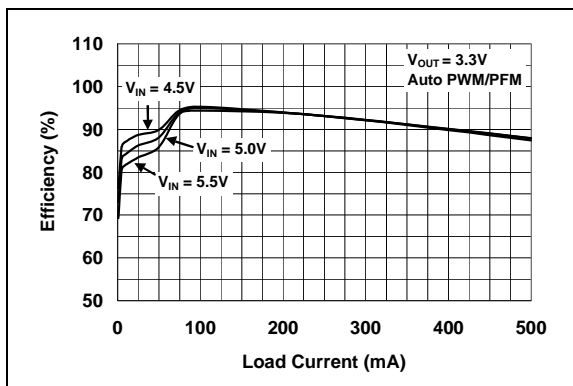
**FIGURE 2-4:** PFM Mode Quiescent Current vs. Input Voltage.



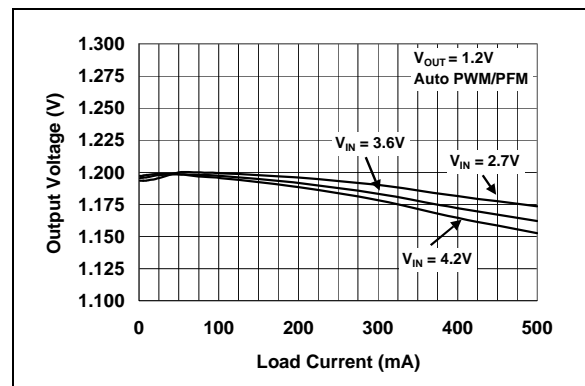
**FIGURE 2-2:** Efficiency vs. Load Current ( $V_{OUT} = 1.8V$ ).



**FIGURE 2-5:** Oscillator Frequency vs. Input Voltage.



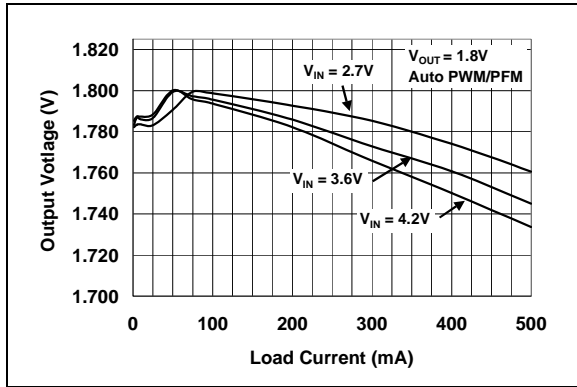
**FIGURE 2-3:** Efficiency vs. Load Current ( $V_{OUT} = 3.3V$ ).



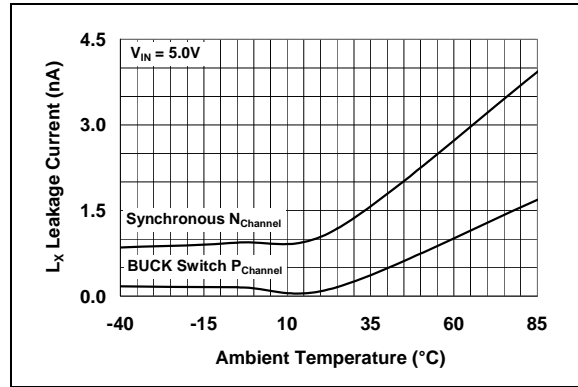
**FIGURE 2-6:** Output Voltage vs. Load Current.

# MCP1601

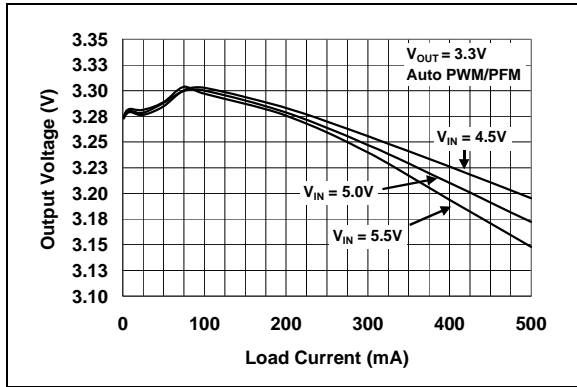
**Note:** Unless otherwise indicated,  $V_{IN} = 4.2V$ ,  $V_{OUT} = 1.8V$ ,  $L = 10 \mu H$ ,  $C_{OUT} = 10 \mu F$  (X5R Ceramic),  $C_{IN} = 10 \mu F$  (X5R Ceramic),  $SYNC/PWM = V_{IN}$ .



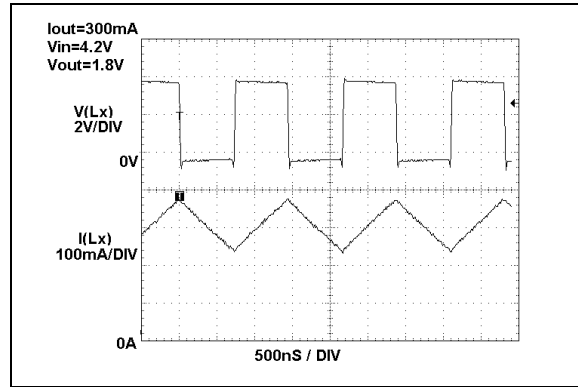
**FIGURE 2-7:** Output Voltage vs. Load Current.



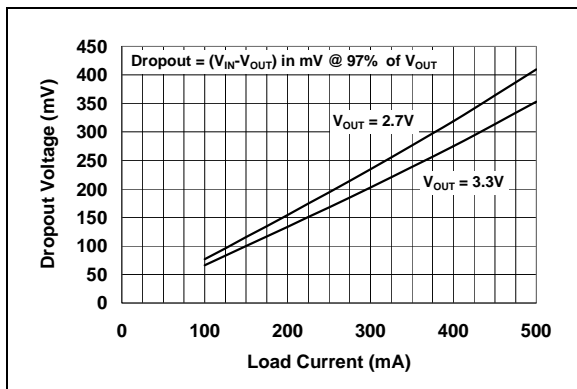
**FIGURE 2-10:** Switch Leakage vs. Temperature.



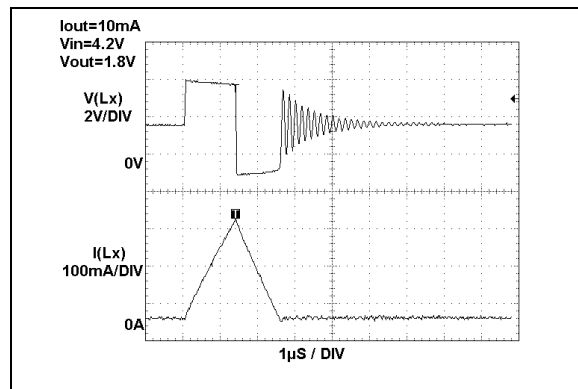
**FIGURE 2-8:** Output Voltage vs. Load Current.



**FIGURE 2-11:** Typical PWM Mode of Operation Waveforms.

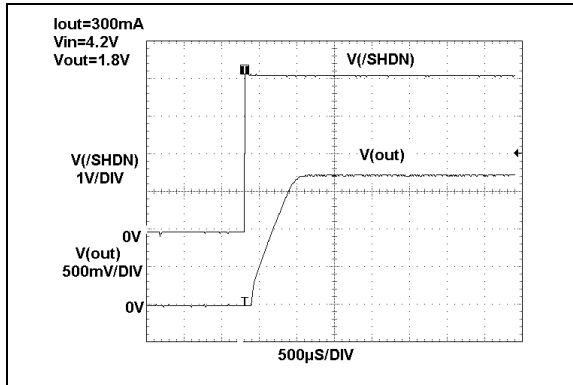


**FIGURE 2-9:** Input to Output Voltage Differential for 100% Duty Cycle vs. Load Current.

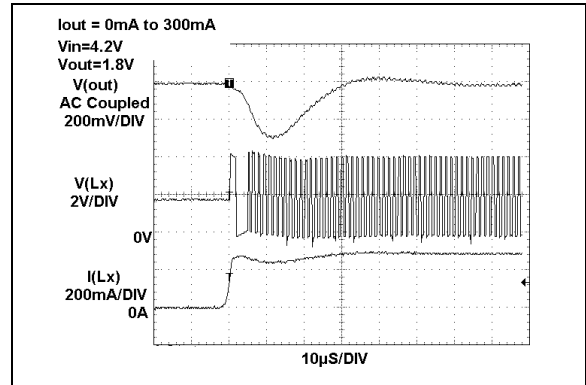


**FIGURE 2-12:** Typical PFM Mode of Operation Waveforms.

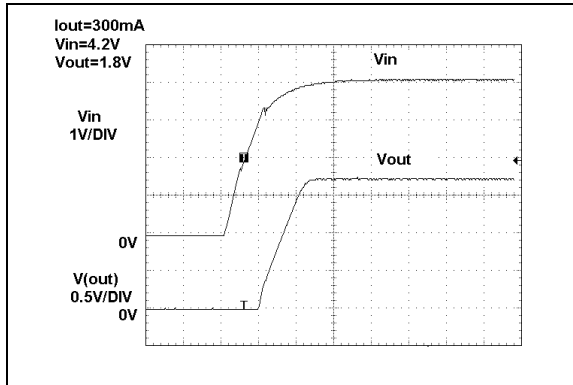
**Note:** Unless otherwise indicated,  $V_{IN} = 4.2V$ ,  $V_{OUT} = 1.8V$ ,  $L = 10 \mu H$ ,  $C_{OUT} = 10 \mu F$  (X5R Ceramic),  $C_{IN} = 10 \mu F$  (X5R Ceramic),  $SYNC/PWM = V_{IN}$ .



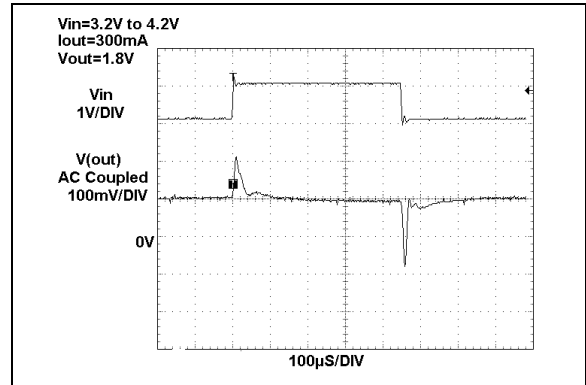
**FIGURE 2-13:** Typical Startup From Shutdown Waveform.



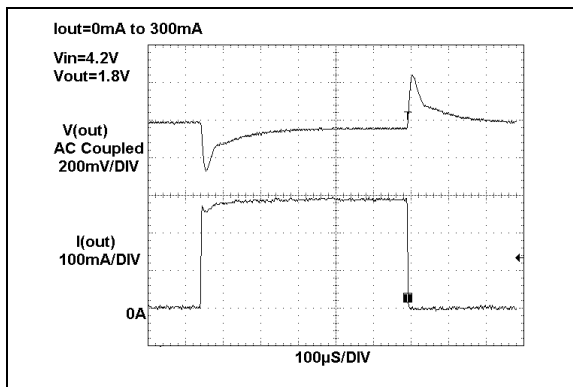
**FIGURE 2-16:** Load Step Response (PFM to PWM).



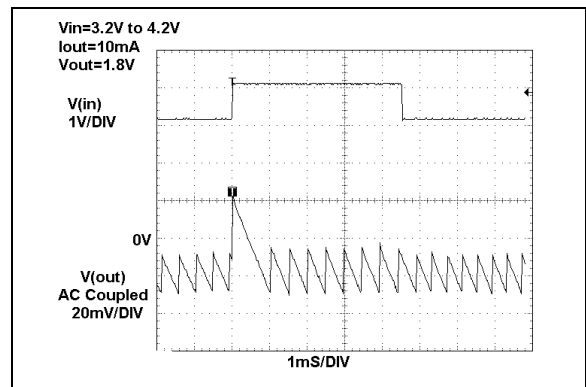
**FIGURE 2-14:** Startup From 0V Input.



**FIGURE 2-17:** Line Step Response (Forced PWM).



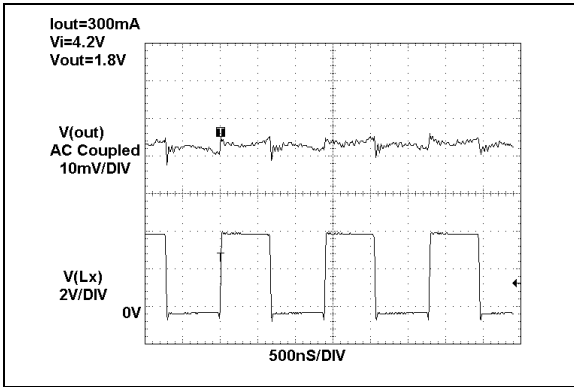
**FIGURE 2-15:** Load Step Response (Forced PWM).



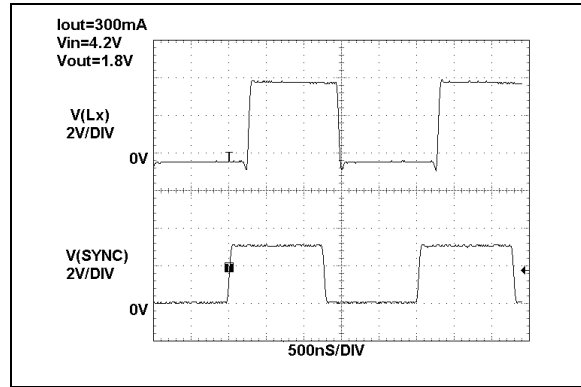
**FIGURE 2-18:** Line Step Response (PFM Mode).

# MCP1601

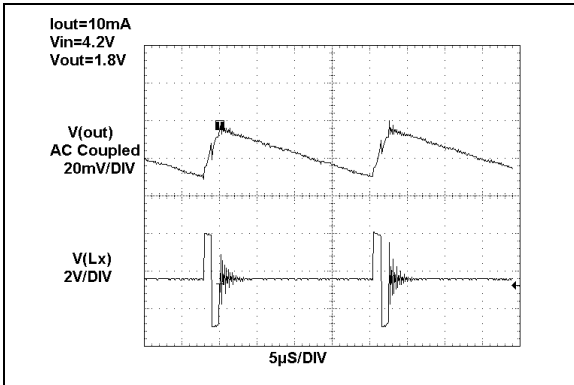
**Note:** Unless otherwise indicated,  $V_{IN} = 4.2V$ ,  $V_{OUT} = 1.8V$ ,  $L = 10 \mu H$ ,  $C_{OUT} = 10 \mu F$  (X5R Ceramic),  $C_{IN} = 10 \mu F$  (X5R Ceramic),  $SYNC/PWM = V_{IN}$ .



**FIGURE 2-19:** Typical Output Ripple Voltage (Forced PWM Mode).



**FIGURE 2-21:** External Oscillator Synchronization.



**FIGURE 2-20:** Typical Output Ripple Voltage (PFM Mode).



## 3.0 PIN FUNCTIONS

TABLE 3-1: PIN FUNCTION TABLE

Pin	Name	Function
1	V <sub>IN</sub>	Input Voltage
2	$\overline{\text{SHDN}}$	Shutdown Input
3	FB	Feedback Input
4	A <sub>GND</sub>	Analog Ground Return
5	SYNC/ PWM	Oscillator Synchronization or PWM/ PFM Select Mode Input
6	V <sub>OUT</sub>	Sensed Output Voltage Input
7	P <sub>GND</sub>	Power Ground Return
8	L <sub>X</sub>	BUCK Inductor Output

### 3.1 Input Voltage (V<sub>IN</sub>)

Connect the unregulated input voltage source to V<sub>IN</sub>. If the input voltage source is located more than several inches away, or is a battery, a typical input capacitor of 10  $\mu\text{F}$  is recommended.

### 3.2 Shutdown Input ( $\overline{\text{SHDN}}$ )

Connect  $\overline{\text{SHDN}}$  to a logic low input to force the device into a shutdown low quiescent current mode. When in shutdown, both the P-Channel and N-Channel switches are turned off, in addition to the internal oscillator and other circuitry. When connected to a logic high input, the device will operate in the selected mode.

### 3.3 Feedback Input (FB)

Connect FB to an external resistor divider to set output voltage regulation. The feedback pin is typically equal to 0.8V. See Section 5.0, "Applications Information", for details in selecting feedback resistors.

### 3.4 Analog Ground Return (A<sub>GND</sub>)

Tie all small signal ground returns to A<sub>GND</sub>. (See Section 5.6, "Printed Circuit Board Layout", for details).

### 3.5 Oscillator Synchronization or PWM/ PFM Select Mode Input (SYNC/PWM)

Connect an external oscillator to SYNC/PWM to synchronize. With an external oscillator present, the device is forced into a PWM-only mode of operation. For internal oscillator operation, the SYNC/PWM pin is tied high to operate in a forced PWM-only mode and low for a PWM/PFM mode of operation.

### 3.6 Output Voltage Sense (V<sub>OUT</sub>)

Connect the output voltage directly to V<sub>OUT</sub> for sensing.

### 3.7 Power Ground Return (P<sub>GND</sub>)

Connect all large signal ground returns to P<sub>GND</sub>. (See Section 5.6, "Printed Circuit Board Layout", for details).

### 3.8 BUCK Inductor Connection (L<sub>X</sub>)

Connect L<sub>X</sub> directly to the BUCK inductor. This pin carries large signal-level currents and all connections should be as short and wide as possible. (See Section 5.6, "Printed Circuit Board Layout", for details).

# MCP1601

---

## 4.0 DEVICE OPERATION

The MCP1601 is a synchronous DC/DC converter with integrated switches. Developed to provide high efficiency across a wide line and load range, the MCP1601 integrates the three modes of operation described below. In addition to three operating modes, the MCP1601 also integrates many features that minimize external circuitry, saving board space and cost. With two external resistors used to set the output voltage, the MCP1601 output is adjustable from 0.9V to  $V_{IN}$ .

### 4.1 Operating Modes

The MCP1601 has three distinct modes of operation, with each one optimized for a specific operating condition commonly encountered in handheld portable power applications.

#### 4.1.1 FEEDFORWARD VOLTAGE PULSE WIDTH MODULATION (PWM) MODE

The Pulse Width Modulation (PWM) mode of operation is desired when operating from typical to maximum output currents with the proper head room voltage at the input. This mode of operation optimizes efficiency and noise by switching at a fixed frequency. Typical output ripple voltage is less than 10 mV when using a 10  $\mu$ H inductor and 10  $\mu$ F ceramic capacitor. The internal operating frequency of the MCP1601 is 750 kHz, nominal. The duty cycle, or "ON" time, of the high-side, integrated, P-Channel MOSFET is determined by the continuous mode BUCK transfer function. For the continuous inductor current case, the duty cycle can be approximated by  $V_{OUT}/V_{IN}$ . The integrated high-side BUCK P-Channel switch will conduct for the "on" time. At the end of the "on" time, the high-side P-Channel switch is turned off and the integrated, low-side, N-Channel synchronous switch is turned on to freewheel the inductor current. The PWM mode architecture employed in the MCP1601 is a feedforward voltage mode control and feeds the input voltage into the PWM oscillator ramp. This information is used to quickly change the operating duty cycle in the event of a sudden input voltage change. The effects on the output voltage are minimized. To force the MCP1601 into PWM mode, the SYNC/PWM pin should be tied to a logic high. The forced PWM mode should be used for applications that require the fastest transient response from light load to heavy load or applications that require a single switching frequency independent of load.

An external oscillator between 850 kHz and 1 MHz can be connected to the SYNC/PWM pin for synchronization to an external clock source. The MCP1601 will always operate in the PWM mode when synchronized to an external oscillator.

#### 4.1.2 PULSE FREQUENCY MODULATION (PFM) MODE

The MCP1601 is also capable of operating in a pulse frequency modulation mode. This mode of operation is desired for applications that have very long periods of inactivity and the output current requirement placed on the MCP1601 is very low. By entering the PFM mode of operation, the switching frequency becomes mainly a function of load current and will decrease as the load current decreases. By switching slower, the energy used turning "on" and "off" the high-side P-Channel and low-side N-Channel is reduced, making the PFM mode more efficient with light output load currents. When load activity is encountered, the MCP1601 will automatically switch from the PFM mode to the fixed frequency PWM mode by sensing the increase in load current. The auto PWM/PFM mode is selected by placing a logic low at the SYNC/PWM input pin. If an external clock is used to synchronize the MCP1601 switching frequency, the PFM mode is automatically disabled.

To enter the PFM mode of operation, the SYNC/PWM pin must be held to a logic low level and the peak inductor current, sensed internal to the MCP1601, is below the internal PFM threshold for more than 1024 clock cycles. If both of these conditions are met, the MCP1601 will enter the PFM mode. While in the PFM mode, the MCP1601 will disable the low-side N-Channel switch to optimize efficiency at low operating currents. A cycle will begin by turning on the high-side P-Channel switch and will end when the output voltage exceeds a predetermined voltage set point. If the peak inductor current exceeds the internal PFM mode current threshold prior to the output voltage exceeding the voltage set point, the load current has increased and the MCP1601 will automatically switch to PWM operation. The typical hysteresis on the PFM comparator is 6 mV. The typical output ripple voltage is below 40 mV when using a 10  $\mu$ H inductor and 10  $\mu$ F ceramic output capacitor when  $V_{IN} = 4.2V$ . For proper PFM mode operation, the value of the external inductor and the external capacitor should be the same. For example, when using a 10  $\mu$ H inductor, a 10  $\mu$ F capacitor should be used. When using a 22  $\mu$ H inductor, a 22  $\mu$ F capacitor should be used.

#### 4.1.3 LOW DROP OUT (LDO) MODE

When the input voltage to the MCP1601 is decreasing and approaches the set output voltage level, the duty cycle increases to a maximum of 90% (typically). To continue to regulate the output to as high a voltage as possible, the MCP1601 enters the low drop out mode of operation. In this mode, the high-side P-Channel MOSFET acts like a saturated LDO. This mode allows the operation of the load circuitry down to the minimum input supply that is typical in battery-powered applications.

## 4.2 Cross-Conduction Timing

Proper timing between turning on the P-Channel, high-side MOSFET and turning off the N-Channel, low-side MOSFET (and vice versa) is critical to obtaining high efficiency. This delay between transitions is what limits the maximum duty cycle obtainable by the MCP1601. The delay between transitions leads to more time when the external inductor current is freewheeling through the internal N-Channel body diode and leads to a decrease in efficiency. If the timing delay is too short and both the internal P-Channel MOSFET and N-Channel MOSFET conduct, high peak currents will be observed shooting through the device. This will also reduce the operating efficiency. The MCP1601 inset timing is integrated to optimize efficiency for the entire line and load operating range of the device.

## 4.3 Integrated Protection Features

### 4.3.1 SHUTDOWN

By placing a logic low on the  $\overline{\text{SHDN}}$  pin of the MCP1601, the device will enter a low quiescent current shutdown mode. This feature turns off all of the internal bias and drivers within the MCP1601 in an effort to minimize the quiescent current. This feature is popular for battery-operated, portable power applications. The shutdown low quiescent current is typically 1  $\mu\text{A}$ .

### 4.3.2 INTERNAL OSCILLATOR AND SYNCHRONIZATION CAPABILITY

The internal oscillator is completely integrated and requires no external components. The frequency is set nominally to 750 kHz in an effort to minimize the external inductor and capacitor size needed for the BUCK topology. In addition to the internal 750 kHz oscillator, the MCP1601 is capable of being synchronized to an external oscillator. The external oscillator frequency must be greater than 850 kHz and less than 1 MHz. For proper synchronization, the duty cycle of the external synchronization clock must be between 10% and 90%. The minimum low voltage level should be below 15% of  $V_{\text{IN}}$  and the high level of the clock should be above 45% of  $V_{\text{IN}}$ . Rise and fall time requirements for the external synchronization clock must be faster than 100 ns from 10% to 90%. When synchronizing to an external clock, the MCP1601 will always operate in the PWM mode in an effort to eliminate multiple switching frequency's and their harmonics.

### 4.3.3 INTERNAL SOFT START

The MCP1601 completely integrates the soft start function and requires no external components. The soft start time is typically 0.5 ms and is reset during over-current and over-temperature shutdown.

### 4.3.4 OVER-TEMPERATURE PROTECTION

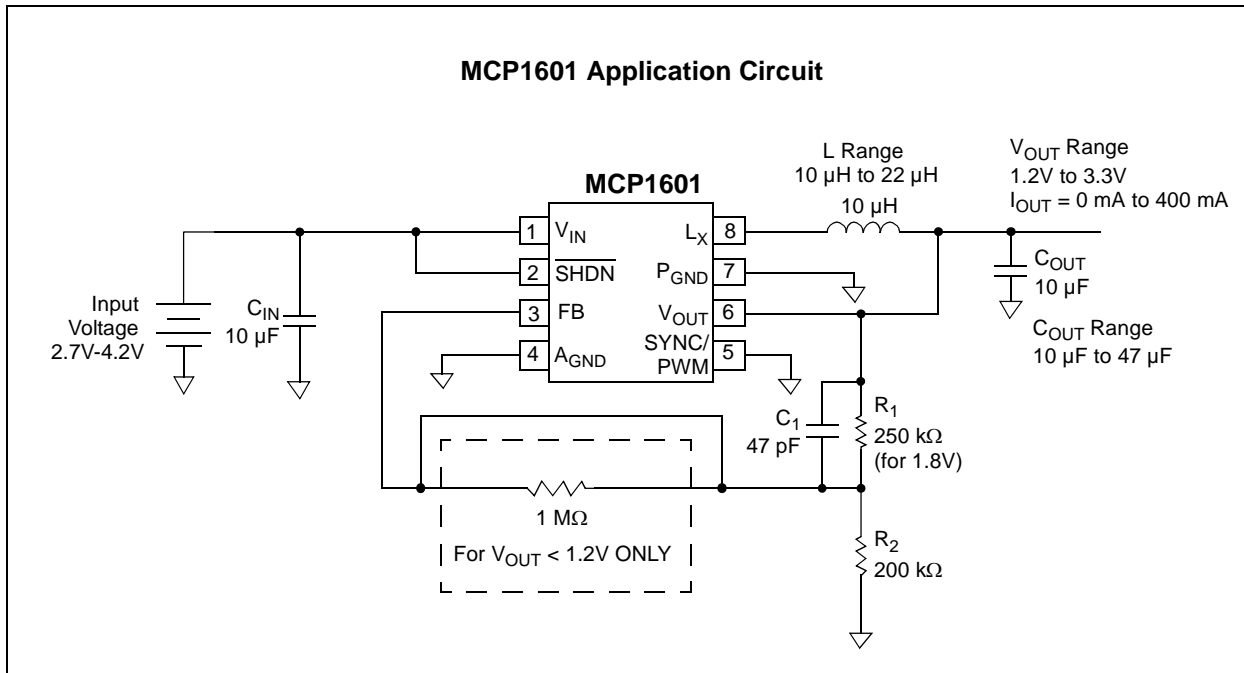
The MCP1601 protects the internal circuitry from over-temperature conditions by sensing the internal device temperature and shutting down when it reaches approximately 160°C. The device will shut down, the temperature will cool to approximately 150°C, soft start will be enabled and normal operation will resume with no external circuit intervention.

### 4.3.5 UNDER-VOLTAGE LOCKOUT

Protection from operating at sustained input voltages that are out of range is prevented with the integrated Under-Voltage Lockout feature. When the input voltage dips below 2.5V (typically), the MCP1601 will shutdown and the soft start circuit will be reset. Normal operation will resume when the input voltage is elevated above 2.7V, maximum. This hysteresis is provided to prevent the device from starting with too low of an input voltage.

# MCP1601

## 5.0 APPLICATIONS INFORMATION



**FIGURE 5-1:** Typical Application Circuit.

### 5.1 Setting Output Voltage

The MCP1601 output voltage is set by using two external resistors for output voltages  $\geq 1.2\text{V}$ . For output voltages  $< 1.2\text{V}$ , a third  $1\text{M}\Omega$  series resistor is necessary to compensate the control system. A  $200\text{ k}\Omega$  resistor is recommended for  $R_2$ , the lower end of the voltage divider. Using higher value resistors will make the circuit more susceptible to noise on the FB pin, causing unstable operation. Lower value resistors can be used down to  $20\text{ k}\Omega$  or below, if necessary.

The feedback reference voltage for the MCP1601 is typically  $0.8\text{V}$ . The equation used to calculate the output voltage is shown below.

#### EQUATION

$$R_1 = R_2 \times [(V_{OUT}/V_{FB}) - 1]$$

Where:  $V_{OUT}$  is the desired output voltage,  
 $V_{FB}$  is the MCP1601 internal feedback reference voltage  
 $R_1$  is the resistor connected to  $V_{OUT}$  in the voltage divider  
 $R_2$  is the resistor connected to ground in the voltage divider

#### Example:

Desired  $V_{OUT} = 2.5\text{V}$

$V_{FB} = 0.8\text{V}$

$R_2 = 200\text{ k}\Omega$

$R_1 = 425\text{ k}\Omega$

### 5.1.1 LEAD CAPACITOR

Capacitor  $C_1$  is used for applications that utilize ceramic output capacitors. To lower the PFM mode ripple voltage, a  $47\text{ pF}$  capacitor for  $C_1$  is used to couple the output AC ripple voltage to the internal PFM mode comparator. For PWM mode, only applications that use electrolytic capacitors that have  $0.2\Omega$  or greater of ESR (Equivalent Series Resistance),  $C_1$  is not necessary.

### 5.2 Choosing External Components

#### 5.2.1 CAPACITORS

The MCP1601 was developed to take full advantage of the latest ceramic capacitor technology, though electrolytic types can be used as well. When selecting the best capacitor for the application, the capacitance, physical size, ESR, temperature coefficient, ripple current ratings (electrolytic) and cost are considered in making the best choice.

When selecting ceramic capacitors for  $C_{OUT}$ , the temperature coefficient of the dielectric should be evaluated. Two dielectrics are recommended as they are stable over a wide temperature range (X5R and X7R). Other dielectrics can be used, but their capacitance should stay within the recommended range over the entire operating temperature range.

## 5.2.1.1 Input

For all BUCK-derived topologies, the input current is pulled from the source in pulses, placing some burden on the input capacitor. For most applications, a 10  $\mu\text{F}$  ceramic capacitor connected to the MCP1601 input is recommended to filter the current pulses. Less capacitance can be used for applications that have low source impedance. The ripple current ratings for ceramic capacitors are typically very high due to their low loss characteristics. Lower-cost electrolytic capacitors can be used, but ripple current ratings should not be exceeded.

## 5.2.1.2 Output

For BUCK-derived topologies, the output capacitor filters the continuous AC inductor ripple current while operating in the PWM mode. Typical inductor AC ripple current for the MCP1601 is 120 mA peak-to-peak with a 3.6V input, 10  $\mu\text{H}$  inductor for a 1.8V output application. Using an output capacitor with 0.3 $\Omega$  of ESR, the output ripple will be approximately 36 mV.

The recommended range for the output capacitor is from 10  $\mu\text{F}$  ( $\pm 20\%$ ) to 47  $\mu\text{F}$  ( $\pm 20\%$ ). Larger value capacitors can be used, but require evaluation of the control system stability.

### EQUATION

$$V_{Ripple} = I_{LRipple} \times C_{OUTesr}$$

The above equation assumes that the output capacitance is large enough so that the ripple voltage (as a result of charging and discharging the capacitor) is negligible and can be used for applications that use electrolytic capacitors with  $esr > 0.3\Omega$ .

When using a 10  $\mu\text{F}$  ceramic X5R dielectric capacitor, the output ripple voltage is typically less than 10 mV.

## 5.2.2 BUCK INDUCTOR

There are many suppliers and choices for selecting the BUCK inductor. The application, physical size requirements (height vs. area), current rating, resistance, mounting method, temperature range, minimum inductance and cost all need to be considered in making the best choice.

When choosing an inductor for the MCP1601 Synchronous BUCK, there are two primary electrical specifications to consider.

1. Current rating of the inductor.
2. Resistance of the inductor.

When selecting a BUCK inductor, many suppliers specify a maximum peak current.

The maximum peak inductor current is equal to the maximum DC output current plus 1/2 the peak-to-peak AC ripple current in the inductor. The AC ripple current in the inductor can be calculated using the following relationship.

### EQUATION

$$V_L = L \times \frac{dI}{dt}$$

Solving for  $\Delta I_L$ :

### EQUATION

$$\Delta I_L = (V_L / L) \times \Delta t$$

Where:  $\Delta t$  is equal to the "on" time of the P-Channel switch and,  
 $V_L$  = the voltage across the inductor  
 $(V_{IN} - V_{OUT})$

### Example:

$$V_{IN} = 3.6\text{V}$$

$$V_{OUT} = 1.8\text{V}$$

$$F_{SW} = 750\text{ kHz}$$

$$I_{OUT(MAX)} = 300\text{ mA}$$

The approximate "on" time is equal to the Duty Cycle  $(V_{OUT} / V_{IN}) \times 1 / F_{SW}$ .

$$T_{ON} = (1.8\text{V} / 3.6\text{V}) \times 1 / (750\text{ kHz})$$

$$T_{ON} = 667\text{ ns}$$

$$V_L = 3.6\text{V} - 1.8\text{V} = 1.8\text{V}$$

$$\Delta I_L = (1.8\text{V} / 10\ \mu\text{H}) \times 667\text{ ns}$$

$$\Delta I_L = 120\text{ mA}$$

$$I_{L(PEAK)} = I_{OUTMAX} + 1/2 \Delta I_L$$

$$I_{L(PEAK)} = 300\text{ mA} + (120\text{ mA}) / 2$$

$$I_{L(PEAK)} = 360\text{ mA}$$

Many suppliers of inductors rate the maximum RMS (Root Mean Square) current. The BUCK inductor RMS current is dependent on the output current, inductance, input voltage, output voltage and switching frequency. For the MCP1601, the inductor RMS current over the 2.7V to 5.5V input range, 0.9V to 5V output voltage range is no more than 15% higher than the average DC output current for the minimum recommended inductance of 10  $\mu\text{H} \pm 20\%$ . When selecting an inductor that has a maximum RMS current rating, use a simple approximation that the RMS current is 1.2 times the maximum output current.

### Example:

$I_{OUT(MAX)} = 300\text{ mA}$ , the inductor should have an RMS rating  $> 360\text{ mA}$  ( $1.2 \times I_{OUT(MAX)}$ ).

# MCP1601

DC resistance is another common inductor specification. The MCP1601 will work properly with inductor DC resistance down to  $0\Omega$ . The trade-off in selecting an inductor with low DC resistance is size and cost. To lower the resistance, larger wire is used to wind the inductor. The switch resistance in the MCP1601 is approximately  $0.5\Omega$ . Inductors with DC resistance lower than  $0.1\Omega$  will not have a significant impact on the efficiency of the converter.

## 5.3 L and C<sub>OUT</sub> Combinations

When selecting the L-C<sub>OUT</sub> output filter components, the inductor value range is limited from  $10\mu\text{H}$  to  $22\mu\text{H}$ . However, when using the larger inductor values, larger capacitor values should be used. The following table lists the recommended combinations of L and C<sub>OUT</sub>.

**TABLE 5-1: L-C<sub>OUT</sub> COMBINATIONS**

L	C <sub>OUT</sub>
$10\mu\text{H}$	$10\mu\text{F}$ to $47\mu\text{F}$
$15\mu\text{H}$	$15\mu\text{F}$ to $47\mu\text{F}$
$22\mu\text{H}$	$22\mu\text{F}$ to $47\mu\text{F}$

**Note:** For proper PFM mode operation, the value of the external inductor and the external capacitor should be the same. For example, when using a  $10\mu\text{H}$  inductor, a  $10\mu\text{F}$  capacitor should be used. When using a  $22\mu\text{H}$  inductor, a  $22\mu\text{F}$  capacitor should be used.

## 5.4 Passive Component Suppliers

**TABLE 5-2: CERAMIC CAPACITOR SUPPLIERS**

Supplier	Type	Description
Murata <sup>®</sup>	Ceramic	$10\mu\text{F}$ 0805 X5R 6.3V #GRM21BR60J106K
Murata <sup>®</sup>	Ceramic	$10\mu\text{F}$ 1206 X5R 6.3V #GRM319R60J106K
Taiyo Yuden <sup>™</sup>	Ceramic	$10\mu\text{F}$ 1210 X5R 6.3V JMK325BJ106MD
AVX <sup>™</sup>	Ceramic	$10\mu\text{F}$ 0805 X5R 6.3V #08056D106MAT4A
AVX <sup>™</sup>	Ceramic	$10\mu\text{F}$ 1206 X5R 6.3V #12066D106MAT4A
Kemet <sup>®</sup>	Ceramic	$10\mu\text{F}$ 1210 6.3V #C1210C106M9PAC
Murata <sup>®</sup>	Ceramic	$22\mu\text{F}$ 1206 X5R 6.3V GRM31CR60J226ME20B
Taiyo Yuden <sup>™</sup>	Ceramic	$22\mu\text{F}$ 1210 X5R 6.3V JMK325BJ226MY

**Note:** Taiyo Yuden 1210 is a low profile case (1.15 mm)

**TABLE 5-3: ELECTROLYTIC CAPACITOR SUPPLIERS**

Supplier	Type	Description
Kemet <sup>®</sup>	Tantalum	$47\mu\text{F}$ D Case 200 M $\Omega$ 10V #T495D476M010AS
AVX <sup>™</sup>	Tantalum	$47\mu\text{F}$ C Case 300 M $\Omega$ 6.3V #TPSC476M006S300
Sprague <sup>®</sup>	Tantalum	$47\mu\text{F}$ C Case 110 M $\Omega$ 16V 594D47X0016C2T
Sprague <sup>®</sup>	Tantalum	$22\mu\text{F}$ B Case 380 M $\Omega$ 6.3V 594D226X06R3B2T
Sprague <sup>®</sup>	Tantalum	$15\mu\text{F}$ B Case 500 M $\Omega$ 10V 594D156X0010B2T

**TABLE 5-4: INDUCTOR SUPPLIERS**

Supplier	L	Type	Area (mm)	Height (mm)	DC Resistance	Max. Current	Series
Sumida®	10 $\mu$ H	Unshielded	4.1 mm x 3.8 mm	3.0 mm	230 M $\Omega$	0.76A	C32
Sumida®	10 $\mu$ H	Shielded	4.0 mm x 4.0 mm	1.8 mm	160 M $\Omega$	0.66A	CDRH3D16
Sumida®	10 $\mu$ H	Shielded	5.7 mm x 5.7 mm	3.0 mm	65 M $\Omega$	1.3A	CDRH5D28
CT*	10 $\mu$ H	Shielded	7.3 mm x 7.3 mm	3.5 mm	70 M $\Omega$	1.7A	CTCDRH73
Coilcraft®	10 $\mu$ H	Shielded	6.6 mm x 4.5 mm	3.0 mm	75 M $\Omega$	1.0A	DS1608
Coilcraft®	15 $\mu$ H	Shielded	6.6 mm x 4.5 mm	3.0 mm	90 M $\Omega$	0.8A	DS1608
Coilcraft®	22 $\mu$ H	Shielded	6.6 mm x 4.5 mm	3.0 mm	110 M $\Omega$	0.7A	DS1608
Coilcraft®	10 $\mu$ H	Unshielded Wafer	6.0 mm x 5.4 mm	1.3 mm	300 M $\Omega$	0.60A	LPO6013
Coilcraft®	15 $\mu$ H	Unshielded Wafer	6.0 mm x 5.4 mm	1.3 mm	380 M $\Omega$	0.55A	LPO6013
Taiyo Yuden™	10 $\mu$ H	Shielded	5.0 mm x 5.0 mm	2.0 mm	66 M $\Omega$	0.7A	NP04SB100M

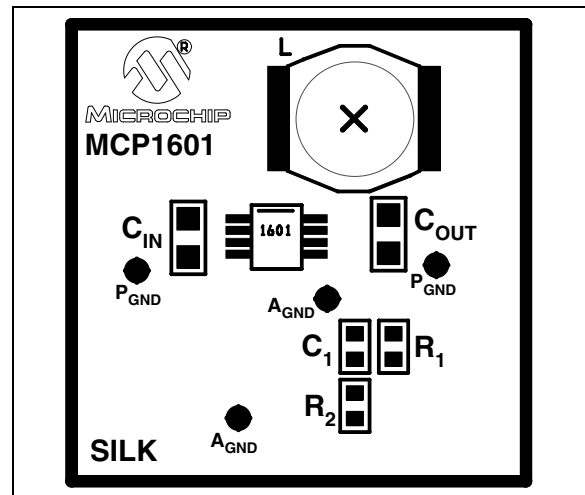
**Note:** CT\* = Central Technologies

## 5.5 Efficiency

Efficiency will be affected by the external component selection and the specific operating conditions for the application. In Section 2.0, “Typical Performance Curves”, there are curves plotted using typical inductors that can be used to estimate the converter efficiency for 1.2V, 1.8V and 3.3V.

## 5.6 Printed Circuit Board Layout

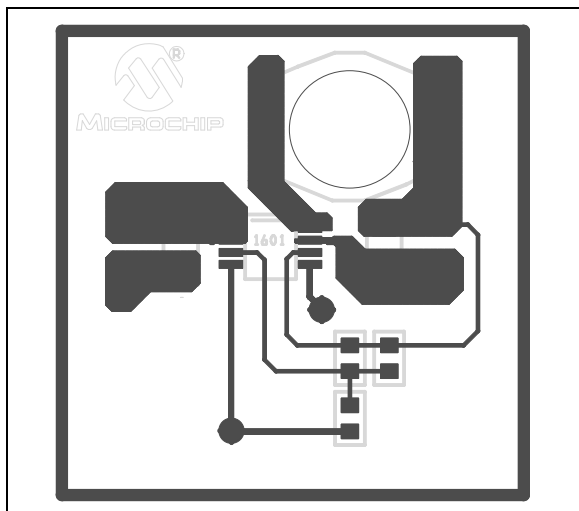
The MCP1601 is capable of switching over 500 mA at 750 kHz. As with all high-frequency, switch mode, power supplies, a good board layout is essential to preventing the noise generated by the power train switching from interfering with the sensing circuitry. The MCP1601 has not demonstrated a sensitivity to layout, but good design practice will prevent undesired results.



**FIGURE 5-2:** Component Placement.

When designing a board layout for the MCP1601, the first thing to consider is the physical placement of the external components. In Figure 5-2, SM0805 10  $\mu$ F ceramic capacitors are used for  $C_{IN}$  and  $C_{OUT}$ . The SM0603 package is used for  $R_1$ ,  $R_2$  and  $C_1$ . The inductor used is the Coilcraft® LPO2506 series low profile (0.047" high). The board outline in this example is 1" x 1".  $C_{IN}$ , L and  $C_{OUT}$  are positioned around the MCP1601 to make the high current paths as short as possible.

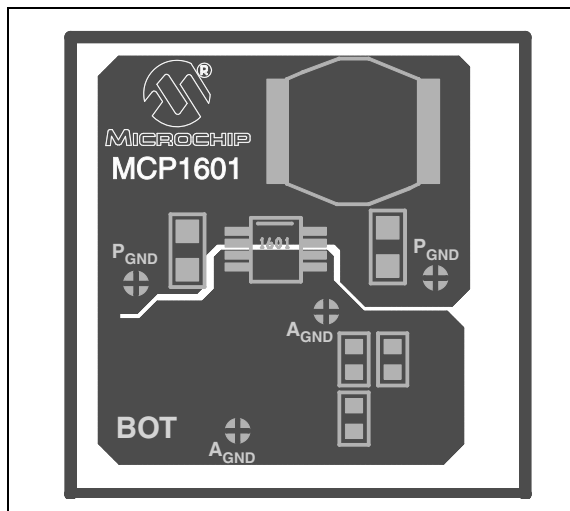
# MCP1601



**FIGURE 5-3:** Top Layer.

The top layer of the board layout is shown in Figure 5-3. The power conversion process is made up of two types of circuits. One circuit carries changing large signals (current, voltage), like  $C_{IN}$ ,  $C_{OUT}$ ,  $L$  and the  $V_{IN}$ ,  $L_X$   $P_{GND}$  pins of the MCP1601. The other circuitry is much smaller in signal and is used to sense, regulate and control the high-power circuitry. These components are  $R_1$ ,  $R_2$ ,  $C_1$  and pins  $FB$ ,  $A_{GND}$ . The top layer is partitioned so that the larger signal connections are short and wide, while the smaller signals are routed away from the large signals.

The MCP1601 utilizes two ground pins to separate the large signal ground current from the small signal circuit ground. The large signal (“Power Ground”) is labeled “ $P_{GND}$ ”. The small signal is labeled “Analog Ground” or “ $A_{GND}$ ”. In Figure 5-3, the  $P_{GND}$  and the  $A_{GND}$  are kept separate on the top layer.



**FIGURE 5-4:** Bottom Layer.

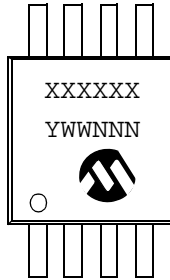
In Figure 5-4, the bottom layer is a partitioned ground plane that connects  $A_{GND}$  to  $P_{GND}$  near the input capacitor. The large signal current will circulate on the top  $P_{GND}$  partition. The lower partition is used for a “quiet” ground, where  $A_{GND}$  is connected.



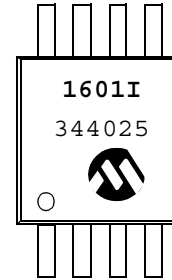
## 6.0 PACKAGING INFORMATION

### 6.1 Package Marking Information

8-Lead MSOP



Example:



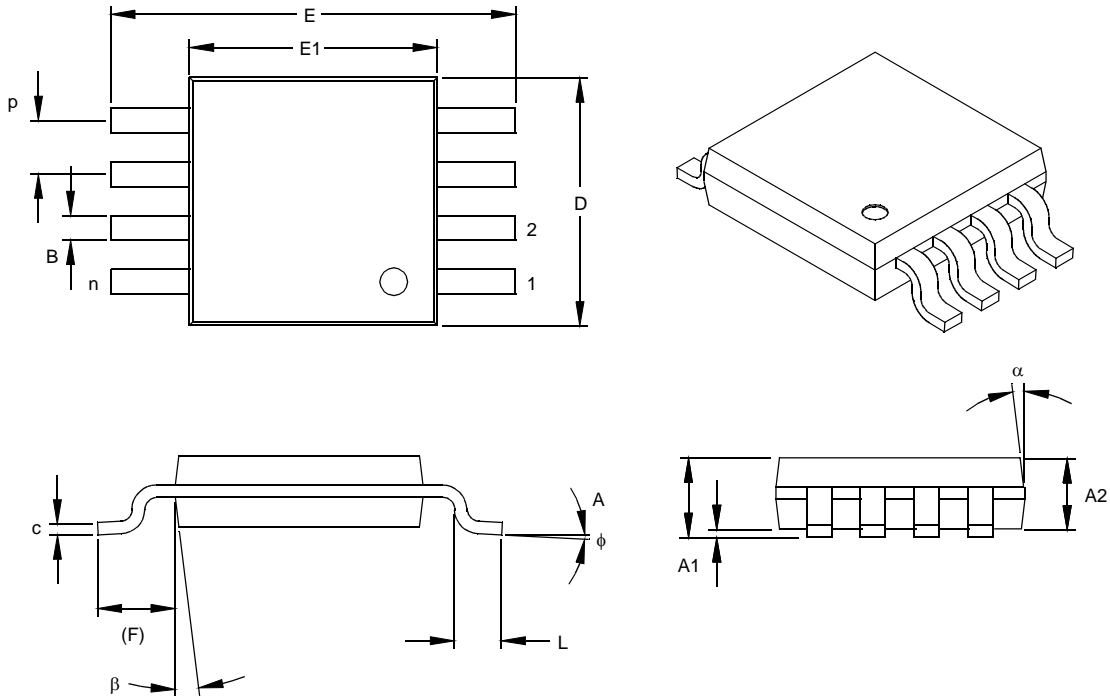
<b>Legend:</b>	XX...X	Customer-specific information
	Y	Year code (last digit of calendar year)
	YY	Year code (last 2 digits of calendar year)
	WW	Week code (week of January 1 is week '01')
	NNN	Alphanumeric traceability code
	(e3)	Pb-free JEDEC designator for Matte Tin (Sn)
	*	This package is Pb-free. The Pb-free JEDEC designator (e3) can be found on the outer packaging for this package.

**Note:** In the event the full Microchip part number cannot be marked on one line, it will be carried over to the next line, thus limiting the number of available characters for customer-specific information.

# MCP1601

## 8-Lead Plastic Micro Small Outline Package (MS) (MSOP)

**Note:** For the most current package drawings, please see the Microchip Packaging Specification located at <http://www.microchip.com/packaging>



Units		INCHES			MILLIMETERS*		
Dimension Limits		MIN	NOM	MAX	MIN	NOM	MAX
Number of Pins	n		8				8
Pitch	p	.026			0.65		
Overall Height	A			.044			1.18
Molded Package Thickness	A2	.030	.034	.038	0.76	0.86	0.97
Standoff §	A1	.002		.006	0.05		0.15
Overall Width	E	.184	.193	.200	4.67	4.90	5.08
Molded Package Width	E1	.114	.118	.122	2.90	3.00	3.10
Overall Length	D	.114	.118	.122	2.90	3.00	3.10
Foot Length	L	.016	.022	.028	0.40	0.55	0.70
Footprint (Reference)	F	.035	.037	.039	0.90	0.95	1.00
Foot Angle	φ	0		6	0		6
Lead Thickness	c	.004	.006	.008	0.10	0.15	0.20
Lead Width	B	.010	.012	.016	0.25	0.30	0.40
Mold Draft Angle Top	α		7			7	
Mold Draft Angle Bottom	β		7			7	

\*Controlling Parameter  
 § Significant Characteristic

**Notes:**

Dimensions D and E1 do not include mold flash or protrusions. Mold flash or protrusions shall not exceed .010" (0.254mm) per side.

Drawing No. C04-111

## 7.0 REVISION HISTORY

### Revision B (January 2013)

Added a note to each package outline drawing.

# MCP1601

---

---

NOTES:

## PRODUCT IDENTIFICATION SYSTEM

To order or obtain information, e.g., on pricing or delivery, refer to the factory or the listed sales office.

<u>PART NO.</u>	<u>X</u>	<u>/XX</u>
Device	Temperature Range	Package
Device:	MCP1601: 500 mA Synchronous BUCK Regulator MCP1601T: 500 mA Synchronous BUCK Regulator Tape and Reel	
Temperature Range:	I = -40°C to +85°C	
Package:	MS = Plastic Micro Small Outline (MSOP), 8-lead	

**Examples:**

- a) MCP1601-I/MS: 8LD MSOP package.
- b) MCP1601T-I/MS: Tape and Reel, 8LD MSOP package.

## Sales and Support

### Data Sheets

Products supported by a preliminary Data Sheet may have an errata sheet describing minor operational differences and recommended workarounds. To determine if an errata sheet exists for a particular device, please contact one of the following:

1. Your local Microchip sales office
2. The Microchip Worldwide Site ([www.microchip.com](http://www.microchip.com))

Please specify which device, revision of silicon and Data Sheet (include Literature #) you are using.

### Customer Notification System

Register on our web site ([www.microchip.com/cn](http://www.microchip.com/cn)) to receive the most current information on our products.

# MCP1601

---

NOTES:

---

**Note the following details of the code protection feature on Microchip devices:**

- Microchip products meet the specification contained in their particular Microchip Data Sheet.
- Microchip believes that its family of products is one of the most secure families of its kind on the market today, when used in the intended manner and under normal conditions.
- There are dishonest and possibly illegal methods used to breach the code protection feature. All of these methods, to our knowledge, require using the Microchip products in a manner outside the operating specifications contained in Microchip's Data Sheets. Most likely, the person doing so is engaged in theft of intellectual property.
- Microchip is willing to work with the customer who is concerned about the integrity of their code.
- Neither Microchip nor any other semiconductor manufacturer can guarantee the security of their code. Code protection does not mean that we are guaranteeing the product as “unbreakable.”

Code protection is constantly evolving. We at Microchip are committed to continuously improving the code protection features of our products. Attempts to break Microchip's code protection feature may be a violation of the Digital Millennium Copyright Act. If such acts allow unauthorized access to your software or other copyrighted work, you may have a right to sue for relief under that Act.

---

Information contained in this publication regarding device applications and the like is provided only for your convenience and may be superseded by updates. It is your responsibility to ensure that your application meets with your specifications. MICROCHIP MAKES NO REPRESENTATIONS OR WARRANTIES OF ANY KIND WHETHER EXPRESS OR IMPLIED, WRITTEN OR ORAL, STATUTORY OR OTHERWISE, RELATED TO THE INFORMATION, INCLUDING BUT NOT LIMITED TO ITS CONDITION, QUALITY, PERFORMANCE, MERCHANTABILITY OR FITNESS FOR PURPOSE. Microchip disclaims all liability arising from this information and its use. Use of Microchip devices in life support and/or safety applications is entirely at the buyer's risk, and the buyer agrees to defend, indemnify and hold harmless Microchip from any and all damages, claims, suits, or expenses resulting from such use. No licenses are conveyed, implicitly or otherwise, under any Microchip intellectual property rights.

#### **Trademarks**

The Microchip name and logo, the Microchip logo, dsPIC, FlashFlex, KEELOQ, KEELOQ logo, MPLAB, PIC, PICmicro, PICSTART, PIC<sup>32</sup> logo, rPIC, SST, SST Logo, SuperFlash and UNI/O are registered trademarks of Microchip Technology Incorporated in the U.S.A. and other countries.

FilterLab, Hampshire, HI-TECH C, Linear Active Thermistor, MTP, SEEVAL and The Embedded Control Solutions Company are registered trademarks of Microchip Technology Incorporated in the U.S.A.

Silicon Storage Technology is a registered trademark of Microchip Technology Inc. in other countries.

Analog-for-the-Digital Age, Application Maestro, BodyCom, chipKIT, chipKIT logo, CodeGuard, dsPICDEM, dsPICDEM.net, dsPICworks, dsSPEAK, ECAN, ECONOMONITOR, FanSense, HI-TIDE, In-Circuit Serial Programming, ICSP, Mindi, MiWi, MPASM, MPF, MPLAB Certified logo, MPLIB, MPLINK, mTouch, Omniclient Code Generation, PICC, PICC-18, PICDEM, PICDEM.net, PICkit, PICTail, REAL ICE, rLAB, Select Mode, SQI, Serial Quad I/O, Total Endurance, TSHARC, UniWinDriver, WiperLock, ZENA and Z-Scale are trademarks of Microchip Technology Incorporated in the U.S.A. and other countries.

SQTP is a service mark of Microchip Technology Incorporated in the U.S.A.

GestIC and ULPP are registered trademarks of Microchip Technology Germany II GmbH & Co. & KG, a subsidiary of Microchip Technology Inc., in other countries.

All other trademarks mentioned herein are property of their respective companies.

© 2003-2013, Microchip Technology Incorporated, Printed in the U.S.A., All Rights Reserved.

 Printed on recycled paper.

ISBN: 9781620768990

**QUALITY MANAGEMENT SYSTEM**  
**CERTIFIED BY DNV**  
**== ISO/TS 16949 ==**

*Microchip received ISO/TS-16949:2009 certification for its worldwide headquarters, design and wafer fabrication facilities in Chandler and Tempe, Arizona; Gresham, Oregon and design centers in California and India. The Company's quality system processes and procedures are for its PIC<sup>®</sup> MCUs and dsPIC<sup>®</sup> DSCs, KEELOQ<sup>®</sup> code hopping devices, Serial EEPROMs, microperipherals, nonvolatile memory and analog products. In addition, Microchip's quality system for the design and manufacture of development systems is ISO 9001:2000 certified.*



# MICROCHIP

## Worldwide Sales and Service

### AMERICAS

**Corporate Office**  
2355 West Chandler Blvd.  
Chandler, AZ 85224-6199  
Tel: 480-792-7200  
Fax: 480-792-7277  
Technical Support:  
<http://www.microchip.com/support>  
Web Address:  
[www.microchip.com](http://www.microchip.com)

**Atlanta**  
Duluth, GA  
Tel: 678-957-9614  
Fax: 678-957-1455

**Boston**  
Westborough, MA  
Tel: 774-760-0087  
Fax: 774-760-0088

**Chicago**  
Itasca, IL  
Tel: 630-285-0071  
Fax: 630-285-0075

**Cleveland**  
Independence, OH  
Tel: 216-447-0464  
Fax: 216-447-0643

**Dallas**  
Addison, TX  
Tel: 972-818-7423  
Fax: 972-818-2924

**Detroit**  
Farmington Hills, MI  
Tel: 248-538-2250  
Fax: 248-538-2260

**Indianapolis**  
Noblesville, IN  
Tel: 317-773-8323  
Fax: 317-773-5453

**Los Angeles**  
Mission Viejo, CA  
Tel: 949-462-9523  
Fax: 949-462-9608

**Santa Clara**  
Santa Clara, CA  
Tel: 408-961-6444  
Fax: 408-961-6445

**Toronto**  
Mississauga, Ontario,  
Canada  
Tel: 905-673-0699  
Fax: 905-673-6509

### ASIA/PACIFIC

**Asia Pacific Office**  
Suites 3707-14, 37th Floor  
Tower 6, The Gateway  
Harbour City, Kowloon  
Hong Kong  
Tel: 852-2401-1200  
Fax: 852-2401-3431

**Australia - Sydney**  
Tel: 61-2-9868-6733  
Fax: 61-2-9868-6755

**China - Beijing**  
Tel: 86-10-8569-7000  
Fax: 86-10-8528-2104

**China - Chengdu**  
Tel: 86-28-8665-5511  
Fax: 86-28-8665-7889

**China - Chongqing**  
Tel: 86-23-8980-9588  
Fax: 86-23-8980-9500

**China - Hangzhou**  
Tel: 86-571-2819-3187  
Fax: 86-571-2819-3189

**China - Hong Kong SAR**  
Tel: 852-2943-5100  
Fax: 852-2401-3431

**China - Nanjing**  
Tel: 86-25-8473-2460  
Fax: 86-25-8473-2470

**China - Qingdao**  
Tel: 86-532-8502-7355  
Fax: 86-532-8502-7205

**China - Shanghai**  
Tel: 86-21-5407-5533  
Fax: 86-21-5407-5066

**China - Shenyang**  
Tel: 86-24-2334-2829  
Fax: 86-24-2334-2393

**China - Shenzhen**  
Tel: 86-755-8864-2200  
Fax: 86-755-8203-1760

**China - Wuhan**  
Tel: 86-27-5980-5300  
Fax: 86-27-5980-5118

**China - Xian**  
Tel: 86-29-8833-7252  
Fax: 86-29-8833-7256

**China - Xiamen**  
Tel: 86-592-2388138  
Fax: 86-592-2388130

**China - Zhuhai**  
Tel: 86-756-3210040  
Fax: 86-756-3210049

### ASIA/PACIFIC

**India - Bangalore**  
Tel: 91-80-3090-4444  
Fax: 91-80-3090-4123

**India - New Delhi**  
Tel: 91-11-4160-8631  
Fax: 91-11-4160-8632

**India - Pune**  
Tel: 91-20-2566-1512  
Fax: 91-20-2566-1513

**Japan - Osaka**  
Tel: 81-6-6152-7160  
Fax: 81-6-6152-9310

**Japan - Tokyo**  
Tel: 81-3-6880-3770  
Fax: 81-3-6880-3771

**Korea - Daegu**  
Tel: 82-53-744-4301  
Fax: 82-53-744-4302

**Korea - Seoul**  
Tel: 82-2-554-7200  
Fax: 82-2-558-5932 or  
82-2-558-5934

**Malaysia - Kuala Lumpur**  
Tel: 60-3-6201-9857  
Fax: 60-3-6201-9859

**Malaysia - Penang**  
Tel: 60-4-227-8870  
Fax: 60-4-227-4068

**Philippines - Manila**  
Tel: 63-2-634-9065  
Fax: 63-2-634-9069

**Singapore**  
Tel: 65-6334-8870  
Fax: 65-6334-8850

**Taiwan - Hsin Chu**  
Tel: 886-3-5778-366  
Fax: 886-3-5770-955

**Taiwan - Kaohsiung**  
Tel: 886-7-213-7828  
Fax: 886-7-330-9305

**Taiwan - Taipei**  
Tel: 886-2-2508-8600  
Fax: 886-2-2508-0102

**Thailand - Bangkok**  
Tel: 66-2-694-1351  
Fax: 66-2-694-1350

### EUROPE

**Austria - Wels**  
Tel: 43-7242-2244-39  
Fax: 43-7242-2244-393

**Denmark - Copenhagen**  
Tel: 45-4450-2828  
Fax: 45-4485-2829

**France - Paris**  
Tel: 33-1-69-53-63-20  
Fax: 33-1-69-30-90-79

**Germany - Munich**  
Tel: 49-89-627-144-0  
Fax: 49-89-627-144-44

**Italy - Milan**  
Tel: 39-0331-742611  
Fax: 39-0331-466781

**Netherlands - Drunen**  
Tel: 31-416-690399  
Fax: 31-416-690340

**Spain - Madrid**  
Tel: 34-91-708-08-90  
Fax: 34-91-708-08-91

**UK - Wokingham**  
Tel: 44-118-921-5869  
Fax: 44-118-921-5820

11/29/12